



Flat Backs Hotfix

03

Featuring a flat reverse side, Flat Backs Hotfix are pre-coated with a heat sensitive glue making them easy to apply to a large range of textiles. Highly versatile and incredibly flexible, they create designs that shimmer with lasting durability.





















The captivating beauty of the Flat Back XILION and XIRIUS Rose is crafted through the use of a unique silver mirror coating on the reverse, amplifying light reflection and creating a warm, luminous appearance.





















Delivering brilliance through exquisite craftsmanship, the XIRIUS Star Rose 2100 joined our coveted XIRIUS Flat Back cuts in February 2025. Embodying Swarovski's dedication to unmatched precision and purity, it elevates modern aesthetics with sartorial elegance and symbolic depth. Merging timeless beauty with functional sophistication, the celestial-inspired cut transforms any design into a statement of contemporary elegance.

Swarovski's outstanding quality is underlined by the highest precision in table size and diameter to ensure brilliance is never compromised.







Colors & Effects



Colors

-  Crystal 001
-  Crystal Hotfix Transparent 001 HFT
-  White Opal 234
-  Light Silk 261
-  Silk 391
-  Light Peach 362
-  Vintage Rose 319
-  Blush Rose 257
-  Light Rose 223
-  Rose Peach 262
-  Padparadscha 542
-  Indian Pink 289
-  Rose 209
-  Fuchsia 502
-  Light Siam 227
-  Scarlet 276
-  Indian Siam 327
-  Siam 208
-  Ruby 501
-  Burgundy 515
-  Amethyst 204



















-  Iris 219
-  Light Amethyst 212
-  Provence Lavender 283
-  Tanzanite 539
-  Purple Velvet 277
-  Aquamarine 202
-  Light Sapphire 211
-  Sapphire 206
-  Capri Blue 243
-  Majestic Blue 296
-  Cobalt 369
-  Dark Indigo 288
-  Montana 207
-  Denim Blue 266
-  Indicolite 379
-  Light Turquoise 263
-  Blue Zircon 229
-  Erinite 360
-  Chrysolite 238
-  Citrus Green 337
-  Fern Green 291

-  Majestic Green 336
-  Emerald 205
-  Jonquil 213
-  Light Topaz 226
-  Light Colorado Topaz 246
-  Topaz 203
-  Greige 284
-  Black Diamond 215
-  Graphite 253
-  Jet 280

- Swarovski ReCreated™ Colors**
-  ReCreated™ Ice Blue 1405
 -  ReCreated™ Dark Sapphire 1404
 -  ReCreated™ Peridot 1408
 -  ReCreated™ Dark Jonquil 1407
 -  ReCreated™ Light Smoked Topaz 1402
 -  ReCreated™ Smoked Topaz 1403



















- TCF™ Colors**
-  Dark Rose 1201 TCF™
 -  Dark Orange 1202 TCF™

Effects







-  Crystal Moonlight
001 MOL
-  Crystal Transmission
Hotfix Transparent
001 TRA HFT
-  Crystal Shimmer
001 SHIM
-  Crystal Aurore Boreale
001 AB
-  Crystal Vitrail Light
001 VL
-  Crystal Paradise Shine
001 PARSH
-  Crystal Vitrail Medium
001 VM
-  Crystal Volcano
001 VOL
-  Crystal Heliotrope
001 HEL
-  Crystal Bermuda Blue
001 BBL
-  Crystal Blue Shade
001 BLSH
-  Crystal Golden Shadow
001 GSHA
-  Crystal Metallic Sunshine
001 METSH
-  Crystal Aurum
001 AUR
-  Crystal Rose Gold
001 ROGL
-  Crystal Light Chrome
001 LTCH
-  Crystal Silver Shade
001 SSHA
-  Crystal Silver Night
001 SINI
-  Jet Hematite
280 HEM

Crystal Lacquer^{PRO} Effects











Crystal Lacquer^{PRO} Ignite Effects

-  Crystal Linen Ignite
001 L164I
-  Crystal Soft Rose Ignite*
001 L167I
-  Crystal Flamingo Ignite
001 L162I
-  Crystal Dahlia Ignite
001 L177I
-  Crystal Orange Ignite
001 L159I
-  Crystal Maroon Ignite
001 L160I
-  Crystal Poppy Red Ignite
001 L179I
-  Crystal Orchid Ignite
001 L171I
-  Crystal Purple Ignite
001 L161I
-  Crystal Sky Ignite
001 L163I
-  Crystal Denim Ignite
001 L166I
-  Crystal Teal Ignite
001 L178I
-  Crystal Pine Green Ignite
001 L170I
-  Crystal Agave Ignite
001 L165I
-  Crystal Soft Mint Ignite
001 L168I
-  Crystal Soft Yellow Ignite
001 L169I
-  Crystal Mango Ignite
001 L152I
-  Crystal Dark Grey Ignite
001 L111I

Crystal Electric Lacquer^{PRO} Ignite Effects





-  Crystal Electric White Ignite
001 L139I
-  Crystal Electric Orange Ignite
001 L136I
-  Crystal Electric Pink Ignite
001 L137I
-  Crystal Electric Violet Ignite
001 L148I
-  Crystal Electric Blue Ignite
001 L134I
-  Crystal Electric Green Ignite
001 L135I
-  Crystal Electric Yellow Ignite
001 L138I

Shimmer Effects

-  Silk Shimmer
391 SHIM
-  Light Rose Shimmer
223 SHIM
-  Fuchsia Shimmer
502 SHIM
-  Light Siam Shimmer
227 SHIM
-  Tanzanite Shimmer
539 SHIM
-  Light Sapphire Shimmer
211 SHIM
-  Blue Zircon Shimmer
229 SHIM
-  ReCreated™ Peridot Shimmer*
1408 SHIM
-  Topaz Shimmer
203 SHIM
-  Black Diamond Shimmer
215 SHIM

*this color does not exist for 2078, but for other Flat Backs. For more details, please see the product matrix on the respective items.

AB Effects

-  Light Rose Aurore Boreale
223 AB
-  Light Siam Aurore Boreale
227 AB
-  Sapphire Aurore Boreale
206 AB
-  Jonquil Aurore Boreale
213 AB
-  Jet Aurore Boreale
280 AB

Nightfall Effects

-  Siam Nightfall
208 NIFA
-  Capri Blue Nightfall
243 NIFA
-  Emerald Nightfall
205 NIFA
-  Graphite Nightfall
253 NIFA

Cabochons

-  Crystal White Pearl
001 650
-  Crystal Nacre
001 191
-  Crystal Creampearl
001 291
-  Crystal Golden Shadow
001 GSHA
-  Crystal Rosaline Pearl
001 294
-  Crystal Dark Grey Pearl
001 617
-  Jet
280
-  Jet Hematite
280 HEM

Crystal Lacquer^{PRO} Ignite Effects

-  Crystal Linen Ignite
001 L164I
-  Crystal Flamingo Ignite
001 L162I
-  Crystal Agave Ignite
001 L165I
-  Crystal Soft Mint Ignite
001 L168I

Crystal Electric Lacquer^{PRO} Ignite Effects

-  Crystal Electric White Ignite
001 L139I
-  Crystal Electric Orange Ignite
001 L136I
-  Crystal Electric Pink Ignite
001 L137I
-  Crystal Electric Violet Ignite
001 L148I
-  Crystal Electric Blue Ignite
001 L134I
-  Crystal Electric Green Ignite
001 L135I
-  Crystal Electric Yellow Ignite
001 L138I

Rimmed Flat Backs

-  Jet Light Chrome Z
280 LTCHZ

Numerical Order

001	Crystal	001 SHIM	Crystal Shimmer	257	Blush Rose
001 191	Crystal Nacre	001 SINI	Crystal Silver Night	261	Light Silk
001 291	Crystal Creampearl	001 SSHA	Crystal Silver Shade	262	Rose Peach
001 294	Crystal Rosaline Pearl	001 TRA HFT	Crystal Transmission Hotfix Transparent	263	Light Turquoise
001 617	Crystal Dark Grey Pearl	001 VL	Crystal Vitrail Light	266	Denim Blue
001 650	Crystal White Pearl	001 VM	Crystal Vitrail Medium	276	Scarlet
001 AB	Crystal Aurore Boreale	001 VOL	Crystal Volcano	277	Purple Velvet
001 AUR	Crystal Aurum	202	Aquamarine	280 AB	Jet Aurore Boreale
001 BBL	Crystal Bermuda Blue	203 SHIM	Topaz Shimmer	280 HEM	Jet Hematite
001 BLSH	Crystal Blue Shade	203	Topaz	280 LTCHZ	Jet Light Chrome Z
001 GSHA	Crystal Golden Shadow	204	Amethyst	280	Jet
001 HEL	Crystal Heliotrope	205 NIFA	Emerald Nightfall	283	Provence Lavender
001 HFT	Crystal Hotfix Transparent	205	Emerald	284	Greige
001 L1111	Crystal Dark Grey Ignite	206 AB	Sapphire Aurore Boreale	288	Dark Indigo
001 L1341	Crystal Electric Blue Ignite	206	Sapphire	289	Indian Pink
001 L1351	Crystal Electric Green Ignite	207	Montana	291	Fern Green
001 L1361	Crystal Electric Orange Ignite	208 NIFA	Siam Nightfall	296	Majestic Blue
001 L1371	Crystal Electric Pink Ignite	208	Siam	319	Vintage Rose
001 L1381	Crystal Electric Yellow Ignite	209	Rose	327	Indian Siam
001 L1391	Crystal Electric White Ignite	211 SHIM	Light Sapphire Shimmer	336	Majestic Green
001 L1481	Crystal Electric Violet Ignite	211	Light Sapphire	337	Citrus Green
001 L1521	Crystal Mango Ignite	212	Light Amethyst	360	Erinite
001 L1591	Crystal Orange Ignite	213 AB	Jonquil Aurore Boreale	362	Light Peach
001 L1601	Crystal Maroon Ignite	213	Jonquil	369	Cobalt
001 L1611	Crystal Purple Ignite	215 SHIM	Black Diamond Shimmer	379	Indicolite
001 L1621	Crystal Flamingo Ignite	215	Black Diamond	391 SHIM	Silk Shimmer
001 L1631	Crystal Sky Ignite	219	Iris	391	Silk
001 L1641	Crystal Linen Ignite	223 AB	Light Rose Aurore Boreale	501	Ruby
001 L1651	Crystal Agave Ignite	223 SHIM	Light Rose Shimmer	502 SHIM	Fuchsia Shimmer
001 L1661	Crystal Denim Ignite	223	Light Rose	502	Fuchsia
001 L1671	Crystal Soft Rose Ignite	226	Light Topaz	515	Burgundy
001 L1681	Crystal Soft Mint Ignite	227 AB	Light Siam Aurore Boreale	539 SHIM	Tanzanite Shimmer
001 L1691	Crystal Soft Yellow Ignite	227 SHIM	Light Siam Shimmer	539	Tanzanite
001 L1701	Crystal Pine Green Ignite	227	Light Siam	542	Padparadscha
001 L1711	Crystal Orchid Ignite	229 SHIM	Blue Zircon Shimmer	1201 TCF™	Dark Rose
001 L1771	Crystal Dahlia Ignite	229	Blue Zircon	1202 TCF™	Dark Orange
001 L1781	Crystal Teal Ignite	234	White Opal	1402	ReCreated™ Light Smoked Topaz
001 L1791	Crystal Poppy Red Ignite	238	Chrysolite	1403	ReCreated™ Smoked Topaz
001 LTCH	Crystal Light Chrome	243 NIFA	Capri Blue Nightfall	1404	ReCreated™ Dark Sapphire
001 METSH	Crystal Metallic Sunshine	243	Capri Blue	1405	ReCreated™ Ice Blue
001 MOL	Crystal Moonlight	246	Light Colorado Topaz	1407	ReCreated™ Dark Jonquil
001 PARSH	Crystal Paradise Shine	253 NIFA	Graphite Nightfall	1408	ReCreated™ Peridot
001 ROGL	Crystal Rose Gold	253	Graphite	1408 SHIM	ReCreated™ Peridot Shimmer

Alphabetical Order

Amethyst (204)	Crystal Orchid Ignite (001 L1711)	Light Amethyst (212)
Aquamarine (202)	Crystal Paradise Shine (001 PARSH)	Light Colorado Topaz (246)
Black Diamond (215)	Crystal Pine Green Ignite (001 L1701)	Light Peach (362)
Black Diamond Shimmer (215 SHIM)	Crystal Poppy Red Ignite (001 L1791)	Light Rose (223)
Blue Zircon (229)	Crystal Purple Ignite (001 L1611)	Light Rose Aurore Boreale (223 AB)
Blue Zircon Shimmer (229 SHIM)	Crystal Rosaline Pearl (001 294)	Light Rose Shimmer (223 SHIM)
Blush Rose (257)	Crystal Rose Gold (001 ROGL)	Light Sapphire (211)
Burgundy (515)	Crystal Shimmer (001 SHIM)	Light Sapphire Shimmer (211 SHIM)
Capri Blue (243)	Crystal Silver Night (001 SINI)	Light Siam (227)
Capri Blue Nightfall (243 1051)	Crystal Silver Shade (001 SSHA)	Light Siam Aurore Boreale (227 AB)
Chrysolite (238)	Crystal Sky Ignite (001 L1631)	Light Siam Shimmer (227 SHIM)
Citrus Green (337)	Crystal Soft Mint Ignite (001 L1681)	Light Silk (261)
Cobalt (369)	Crystal Soft Rose Ignite (001 L1671)	Light Topaz (226)
Crystal (001)	Crystal Soft Yellow Ignite (001 L1691)	Light Turquoise (263)
Crystal Aurore Boreale (001 AB)	Crystal Teal Ignite (001 L1781)	Majestic Blue (296)
Crystal Aurum (001 AUR)	Crystal Transmission Hotfix Transparent (001 TRA HFT)	Majestic Green (336)
Crystal Agave Ignite (001 L1651)	Crystal Vitrail Light (001 VL)	Montana (207)
Crystal Bermuda Blue (001 BBL)	Crystal Vitrail Medium (001 VM)	Padparadscha (542)
Crystal Blue Shade (001 BLSH)	Crystal Volcano (001 VOL)	Provence Lavender (283)
Crystal Creamppearl (001 291)	Crystal White Pearl (001 650)	Purple Velvet (277)
Crystal Dahlia Ignite (001 L1771)	Dark Indigo (288)	ReCreated™ Dark Jonquil (1407)
Crystal Dark Grey Ignite (001 L1111)	Dark Orange (1202 TCF™)	ReCreated™ Dark Sapphire (1404)
Crystal Dark Grey Pearl (001 617)	Dark Rose (1201 TCF™)	ReCreated™ Ice Blue (1405)
Crystal Denim Ignite (001 L1661)	Denim Blue (266)	ReCreated™ Light Smoked Topaz (1402)
Crystal Electric Blue Ignite (001 L1341)	Emerald (205)	ReCreated™ Peridot (1408)
Crystal Electric Green Ignite (001 L1351)	Emerald Nightfall (205 NIFA)	ReCreated™ Peridot Shimmer (1408 SHIM)
Crystal Electric Pink Ignite (001 L1371)	Erinite (360)	ReCreated™ Smoked Topaz (1403)
Crystal Electric Violet Ignite (001 L1481)	Fern Green (291)	Rose (209)
Crystal Electric White Ignite (001 L1391)	Fuchsia (502)	Rose Peach (262)
Crystal Electric Yellow (001 L138S)	Fuchsia Shimmer (502 SHIM)	Ruby (501)
Crystal Electric Yellow Ignite (001 L1381)	Graphite (253)	Sapphire (206)
Crystal Flamingo Ignite (001 L1621)	Graphite Nightfall (253 NIFA)	Sapphire Aurore Boreale (206 AB)
Crystal Golden Shadow (001 GSHA)	Greige (284)	Scarlet (276)
Crystal Heliotrope (001 HEL)	Indian Pink (289)	Siam (208)
Crystal Hotfix Transparent (001 HFT)	Indian Siam (327)	Siam Nightfall (208 NIFA)
Crystal Light Chrome (001 LTCH)	Indicolite (379)	Silk (391)
Crystal Linen Ignite (001 L1641)	Iris (219)	Silk Shimmer (391 SHIM)
Crystal Mango Ignite (001 L1521)	Jet (280)	Tanzanite (539)
Crystal Maroon Ignite (001 L1601)	Jet Aurore Boreale (280 AB)	Tanzanite Shimmer (539 SHIM)
Crystal Metallic Sunshine (001 METSH)	Jet Hematite (280 HEM)	Topaz (203)
Crystal Moonlight (001 MOL)	Jet Light Chrome Z (280 LTCHZ)	Topaz Shimmer (203 SHIM)
Crystal Nacre (001 191)	Jonquil (213)	Vintage Rose (319)
Crystal Orange Ignite (001 L1591)	Jonquil Aurore Boreale (213 AB)	White Opal (234)

For details on available colors and effects for each article within the product groups, please see the product matrix of the respective item in the Collection 2026.











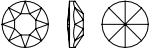















The plating resistance of effects is tested according to Swarovski's plating guidelines (SWAROVSKI.COM/S-PROFESSIONALS). Customers are advised to carry out their own tests if their plating parameters diverge from Swarovski plating guidelines.

Colors and effects can appear different when illuminated with different light sources. Swarovski uses standard light source D65 for color decision and comparison. Slight changes in shades are unavoidable. Colors may vary according to cut and foiling.

The composition of Advanced Crystal is compliant with regulatory industry norms and laws regarding the restriction or prohibition of certain substances in the most relevant segments of our customers. Please note that the compliance of the colors Light Siam and Siam varies according to certain industry regulations. Those regulations are indicated with * in the compliance overview. Indian Siam, Ruby and Scarlet (option to Lt. Siam) conform to all CLEAR-lists. For further information please visit swarovski.com/s-professionals

© 2026 D. Swarovski Distribution GmbH

Summary

1 2 3		1098 A HF PP 24 (SS 12), PP 31 (SS 16) SS 20, 24, 29, 34, 39	1 2		2300 M HF 8x4.8 mm	1 2		2602 M HF 3.7x2.5, 8x5.5, 14x10 mm
		2000 A HF SS 3			2303 M HF 8x5, 14x9 mm			2603 M HF 4x3, 8x6, 14x10 mm
		2038 A HF SS 5, 6, 8, 10			2304 M HF 10x2.8, 14x3.9 mm			2709 M HF 10x6 mm
		2038/1 A HF SS 10			2400 M HF 2.2, 3, 4, 6 mm			2711 M HF 3.3, 6 mm
		2078 A HF SS 12, 16, 20, 30, 34, 40, 48			2471 M HF 5, 7, 10 mm			2715 M HF 3, 4, 6 mm
		2078/1 A HF SS 16, 20			2472 M HF 5, 7, 10 mm			2738 M HF 10x5, 12x6 mm
		2080/4 HF SS 6, 10, 16, 20, 34			2510 M HF 3.7x1.9, 5x2.5 mm			2739 M HF 5.8x5.3, 7x6.5 mm
		2100 SS 12, 16, 20, 30, 34, 40, 48			2555 M HF 8x2.6, 12x4 mm			2740 M HF 8.3x8.3, 10x10 mm
		2200 M HF 4x2, 8x4 mm						
		2201 M HF 4x1.8, 8x3.5, 14x6 mm						
		2205 M HF 7.5, 10, 14 mm						

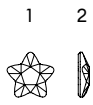

2754 M HF
4, 6 mm

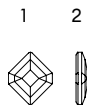

2777 M HF
5x4.2, 6.7x5.6,
10x8.4 mm



2770 M HF
6x3.5 mm



2788 M HF
8 mm



2771 M HF
6.4x4.2, 8.6x5.6,
12.9x8.3 mm



2808 M HF
3.6, 6, 10 mm



2772 M HF
6.5x2.1, 8.6x2.8,
12.9x4.2 mm



2813 M HF
8x5.5 mm



2773 M HF
5x3, 6.6x3.9,
9.9x5.9 mm



2816 M HF
5 mm

Summary



2774 M HF
6.3x4.2, 8.3x5.6,
12.5x8.4 mm



2775 M HF
5x4.2, 6.7x5.6,
10x8.4 mm



2776 M HF
8.2x4.2, 11x5.6,
16.5x8.4 mm

1098 XIRIUS Light

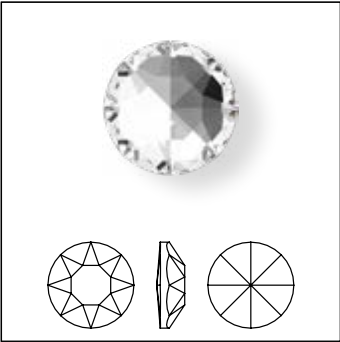

Size	PP 24	PP 31	SS 20
Crystal			
Crystal A HF (001)	■	■	■
Crystal Effects			
Transparent Effects			
Crystal Aurore Boreale A HF (001 AB)	■	■	■
Crystal Golden Shadow A HF (001 GSHA)	■	■	■
Crystal Silver Night A HF (001 SINI)	■	■	■
Crystal Silver Shade A HF (001 SSHA)	■	■	■

Crystal

Crystal A HF (001)

Crystal Effects

Transparent Effects

Crystal Aurore Boreale A HF (001 AB)

Crystal Golden Shadow A HF (001 GSHA)

Crystal Silver Night A HF (001 SINI)

Crystal Silver Shade A HF (001 SSHA)

2000 Rose

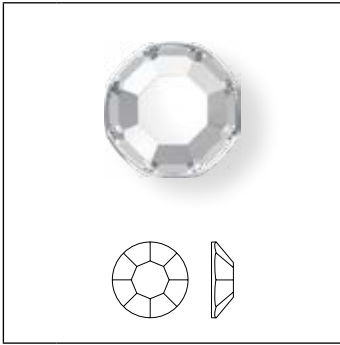

Size SS 3

2038 XILION Rose

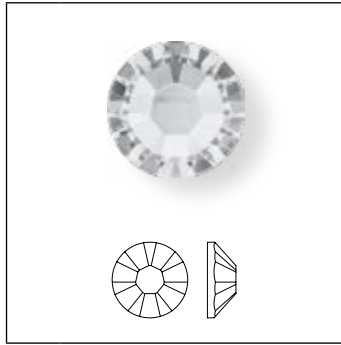

Size SS 5, 6, 8, 10

2078 XIRIUS Rose



Size SS 12, 16, 20, 30, 34, 40, 48

	2000	2038	2078
Crystal			
Crystal Hotfix Transparent (001 HFT)	■	■	■
Crystal A HF (001)	■	■	■
Colors			
Plain Colors			
Amethyst A HF (204)	■	■	■
Aquamarine A HF (202)	■	■	■
Black Diamond A HF (215)	■	■	■
Blue Zircon A HF (229)	■	■	■
Blush Rose A HF (257)	■	■	■
Burgundy A HF (515)	■	■	■
Capri Blue A HF (243)	■	■	■
Chrysolite A HF (238)	■	■	■
Citrus Green A HF (337)	■	■	■
Cobalt A HF (369)	■	■	■
Dark Indigo A HF (288)	■	■	■
Denim Blue A HF (266)	■	■	■
Emerald A HF (205)	■	■	■
Erinite A HF (360)	■	■	■
Fern Green A HF (291)	■	■	■
Fuchsia A HF (502)	■	■	■
Graphite A HF (253)	■	■	■
Greige A HF (284)	■	■	■
Indian Pink A HF (289)	■	■	■
Indian Siam A HF (327)	■	■	■

	2000		2038				2078								
	2000 Rose	SS 3	2038 XILLION Rose	SS 5	SS 6	SS 8	SS 10	2078 XIRIUS Rose	SS 12	SS 16	SS 20	SS 30	SS 34	SS 40	SS 48
Indicolite A HF (379)															
Iris A HF (219)															
Jet (280)															
Jet A HF (280)		■		■											■
Jonquil A HF (213)		■													
Light Amethyst A HF (212)															
Light Colorado Topaz A HF (246)		■													■
Light Peach A HF (362)		■													
Light Rose A HF (223)		■													■
Light Sapphire A HF (211)		■													■
Light Siam A HF (227)		■													■
Light Silk A HF (261)															■
Light Topaz A HF (226)															■
Light Turquoise A HF (263)															
Majestic Blue A HF (296)															
Majestic Green A HF (336)															■
Montana A HF (207)		■													
Padparadscha A HF (542)															
Provence Lavender A HF (283)															
Purple Velvet A HF (277)															
Rose A HF (209)		■													■
Rose Peach A HF (262)		■													
Ruby A HF (501)															
Sapphire A HF (206)		■													■
Scarlet A HF (276)															
Siam A HF (208)															
Silk A HF (391)		■													■
Tanzanite A HF (539)		■													
Topaz A HF (203)															■
Vintage Rose A HF (319)		■													■
Opal Colors															
White Opal A HF (234)															
Swarovski ReCreated™ Colors															
ReCreated™ Dark Jonquil A HF (1407)															
ReCreated™ Dark Sapphire A HF (1404)		■													
ReCreated™ Ice Blue A HF (1405)															
ReCreated™ Light Smoked Topaz A HF (1402)		■													
ReCreated™ Peridot A HF (1408)		■													■
ReCreated™ Smoked Topaz A HF (1403)		■													

	2000		2038				2078									
	Size	2000 Rose	SS 3	2038 XILLION Rose	SS 5	SS 6	SS 8	SS 10	2078 XIRIUS Rose	SS 12	SS 16	SS 20	SS 30	SS 34	SS 40	SS 48
Crystal Sky Ignite HFT (001 L1631)																
Crystal Soft Mint Ignite HFT (001 L1681)																
Crystal Soft Rose Ignite HFT (001 L1671)																
Crystal Soft Yellow Ignite HFT (001 L1691)																
Crystal Teal Ignite HFT (001 L1781)																
Crystal Electric Lacquer^{PRO} Ignite Effects																
Crystal Electric Blue Ignite HFT (001 L1341)																
Crystal Electric Green Ignite HFT (001 L1351)																
Crystal Electric Orange Ignite HFT (001 L1361)																
Crystal Electric Pink Ignite HFT (001 L1371)																
Crystal Electric Violet Ignite HFT (001 L1481)																
Crystal Electric White Ignite HFT (001 L1391)																
Crystal Electric Yellow Ignite HFT (001 L1381)																
Color Effects																
Transparent Effects																
Black Diamond Shimmer A HF (215 SHIM)																
Blue Zircon Shimmer A HF (229 SHIM)																
Capri Blue Nightfall A HF (243 NIFA)																
Emerald Nightfall A HF (205 NIFA)																
Fuchsia Shimmer A HF (502 SHIM)																
Graphite Nightfall A HF (253 NIFA)																
Jet AB A HF (280 AB)																
Jonquil AB A HF (213 AB)																
Light Rose AB A HF (223 AB)																
Light Rose Shimmer A HF (223 SHIM)																
Light Sapphire Shimmer A HF (211 SHIM)																
Light Siam AB A HF (227 AB)																
Light Siam Shimmer A HF (227 SHIM)																
ReCreated™ Peridot Shimmer A HF (1408 SHIM)																
Sapphire AB A HF (206 AB)																
Siam Nightfall A HF (208 NIFA)																
Silk Shimmer A HF (391 SHIM)																
Tanzanite Shimmer A HF (539 SHIM)																
Topaz Shimmer A HF (203 SHIM)																
Metallic Effects																
Jet Hematite A HF (280 HEM)																

2038/I Rimmed Flat Back

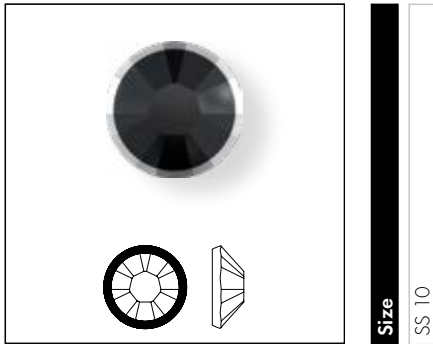

Size
SS 10

Color Effects

Metallic Effects

● Jet & Light Chrome Z A HF (280 LTCHZ)

2078/I Rimmed Flat Back

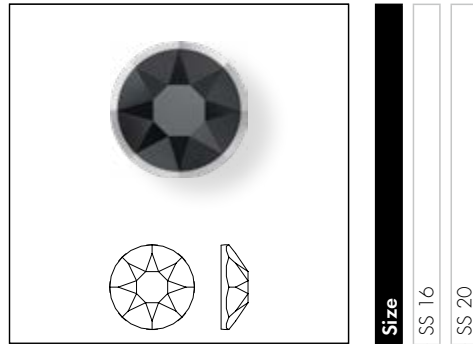

Size
SS 16
SS 20

Color Effects

Metallic Effects

● Jet & Light Chrome Z A HF (280 LTCHZ)

CABOCHON

2080/4 Cabochon



Size	SS 6	SS 10	SS 16	SS 20	SS 34
------	------	-------	-------	-------	-------

Colors

Plain Colors

Jet M HF (280)

Crystal Effects

Transparent Effects

Crystal Golden Shadow HF (001 GSHA)

Color Effects

Metallic Effects

Jet Hematite M HF (280 HEM)

Crystal Effects

Crystal Lacquer^{PRO} Effects

Crystal Lacquer^{PRO} Ignite Effects

Crystal Agave Ignite HFT (001 L1651)

Crystal Flamingo Ignite HFT (001 L1621)

Crystal Linen Ignite HFT (001 L1641)

Crystal Soft Mint Ignite HFT (001 L1681)

Crystal Electric Lacquer^{PRO} Ignite Effects

Crystal Electric Blue Ignite HFT (001 L1341)

Crystal Electric Green Ignite HFT (001 L1351)

Crystal Electric Orange Ignite HFT (001 L1361)

Crystal Electric Pink Ignite HFT (001 L1371)

Crystal Electric Violet Ignite HFT (001 L1481)

Crystal Electric White Ignite HFT (001 L1391)

Crystal Electric Yellow Ignite HFT (001 L1381)

Pearl Colors

Crystal Creampearl HF (001 CMPRL)

Crystal Dark Grey Pearl HF (001 DGREY)

Crystal Nacre HF (001 NACRE)

Crystal Rosaline Pearl HF (001 ROPRL)

Crystal White Pearl HF (001 WHITE)

Jet M HF (280)	■	■	■	■	■
Crystal Golden Shadow HF (001 GSHA)	■	■	■	■	■
Jet Hematite M HF (280 HEM)	■	■	■	■	■
Crystal Agave Ignite HFT (001 L1651)		■	■	■	■
Crystal Flamingo Ignite HFT (001 L1621)		■	■	■	■
Crystal Linen Ignite HFT (001 L1641)		■	■	■	■
Crystal Soft Mint Ignite HFT (001 L1681)		■	■	■	■
Crystal Electric Blue Ignite HFT (001 L1341)		■	■	■	■
Crystal Electric Green Ignite HFT (001 L1351)		■	■	■	■
Crystal Electric Orange Ignite HFT (001 L1361)		■	■	■	■
Crystal Electric Pink Ignite HFT (001 L1371)		■	■	■	■
Crystal Electric Violet Ignite HFT (001 L1481)		■	■	■	■
Crystal Electric White Ignite HFT (001 L1391)		■	■	■	■
Crystal Electric Yellow Ignite HFT (001 L1381)		■	■	■	■
Crystal Creampearl HF (001 CMPRL)	■	■	■	■	■
Crystal Dark Grey Pearl HF (001 DGREY)	■	■	■	■	■
Crystal Nacre HF (001 NACRE)	■	■	■	■	■
Crystal Rosaline Pearl HF (001 ROPRL)	■	■	■	■	■
Crystal White Pearl HF (001 WHITE)	■	■	■	■	■

2100 XIRIUS Star Rose



Size	SS 12	SS 16	SS 20	SS 30	SS 34	SS 40	SS 48
------	-------	-------	-------	-------	-------	-------	-------

Crystal

Crystal A HF (001)	■	■	■	■	■	■	■
--------------------	---	---	---	---	---	---	---

Colors

Plain Colors

Black Diamond A HF (215)	■	■	■	■	■	■	■
Graphite A HF (253)	■	■	■	■	■	■	■
Light Colorado Topaz A HF (246)	■	■	■	■	■	■	■
Light Rose A HF (223)	■	■	■	■	■	■	■
Light Siam A HF (227)	■	■	■	■	■	■	■
Light Silk A HF (261)	■	■	■	■	■	■	■
Majestic Green A HF (336)	■	■	■	■	■	■	■
Silk A HF (391)	■	■	■	■	■	■	■

ReCreated™ Colors

ReCreated™ Dark Jonquil A HF (1407)	■	■	■	■	■	■	■
ReCreated™ Dark Sapphire A HF (1404)	■	■	■	■	■	■	■
ReCreated™ Ice Blue A HF (1405)	■	■	■	■	■	■	■

TCF™ Colors

Dark Orange A HF (1202 TCF™)	■	■	■	■	■	■	■
Dark Rose A HF (1201 TCF™)	■	■	■	■	■	■	■

Crystal Effects

Transparent Effects

Crystal Aurore Boreale A HF (001 AB)	■	■	■	■	■	■	■
Crystal Blue Shade A HF (001 BLSH)	■	■	■	■	■	■	■
Crystal Golden Shadow A HF (001 GSHA)	■	■	■	■	■	■	■
Crystal Moonlight A HF (001 MOL)	■	■	■	■	■	■	■
Crystal Shimmer A HF (001 SHIM)	■	■	■	■	■	■	■
Crystal Silver Night A HF (001 SINI)	■	■	■	■	■	■	■
Crystal Silver Shade A HF (001 SSHA)	■	■	■	■	■	■	■

Metallic Effects

Crystal Light Chrome A HF (001 LTCH)	■	■	■	■	■	■	■
Crystal Metallic Sunshine A HF (001 METSH)	■	■	■	■	■	■	■

Color Effects

Metallic Effects

Jet Hematite A HF (280 HEM)	■	■	■	■	■	■	■
-----------------------------	---	---	---	---	---	---	---

2200 Navette Flat Back

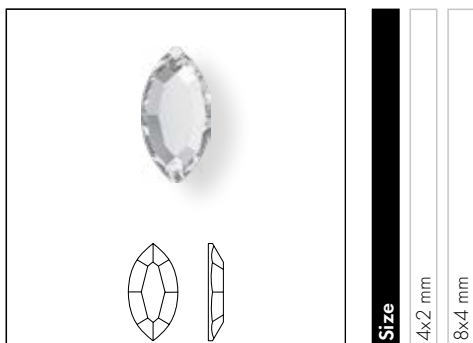

Crystal		4x2 mm	8x4 mm
Crystal M HF (001)		■	■
Colors			
Plain Colors			
Aquamarine M HF (202)		■	■
Black Diamond M HF (215)		■	■
Emerald M HF (205)		■	■
Jet M HF (280)		■	■
Light Colorado Topaz M HF (246)		■	■
Light Rose M HF (223)		■	■
Scarlet M HF (276)		■	■
ReCreated™ Colors			
ReCreated™ Dark Jonquil M HF (1407)		■	
ReCreated™ Light Smoked Topaz M HF (1402)		■	
ReCreated™ Peridot M HF (1408)		■	
ReCreated™ Smoked Topaz M HF (1403)		■	
TCF™ Colors			
Dark Orange M HF (1202 TCF™)		■	
Crystal Effects			
Transparent Effects			
Crystal Aurore Boreale M HF (001 AB)		■	■
Crystal Golden Shadow M HF (001 GSHA)		■	■
Crystal Heliotrope M HF (001 HEL)		■	■
Crystal Shimmer M HF (001 SHIM)		■	■
Crystal Silver Shade M HF (001 SSHA)		■	■
Metallic Effects			
Crystal Aurum M HF (001 AUR)		■	■

2201 Marquise Flat Back

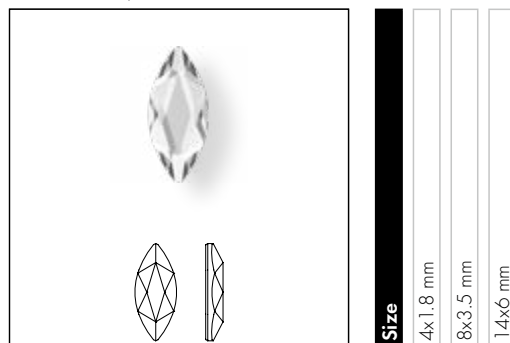

Crystal		4x1.8 mm	8x3.5 mm	14x6 mm
Crystal M HF (001)		■	■	■
Crystal Effects				
Transparent Effects				
Crystal Aurore Boreale M HF (001 AB)		■	■	■
Crystal Golden Shadow M HF (001 GSHA)		■	■	■
Crystal Heliotrope M HF (001 HEL)		■	■	■
Crystal Shimmer M HF (001 SHIM)		■	■	■

2205 Flame Flat Back

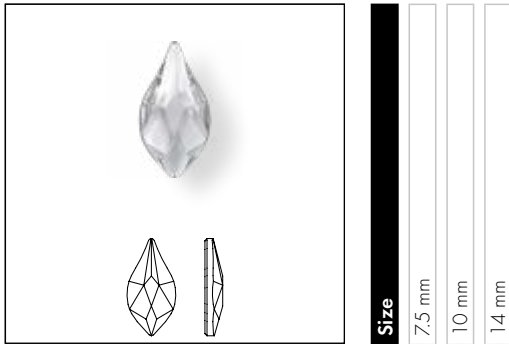

Crystal	
Crystal M HF (001)	■ ■ ■
Colors	
TCF™ Colors	
Dark Orange M HF (1202)	■ ■ ■
Crystal Effects	
Transparent Effects	
Crystal Aurore Boreale M HF (001 AB)	■ ■ ■
Crystal Golden Shadow M HF (001 GSHA)	■ ■ ■

2300 Drop Flat Back

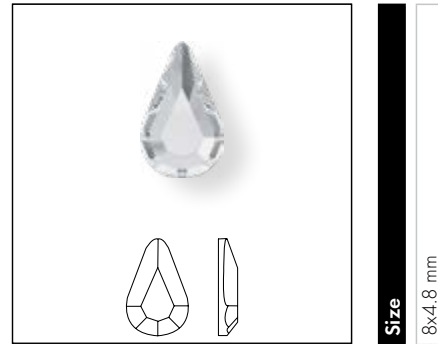

Crystal	
Crystal M HF (001)	■
Colors	
Plain Colors	
Aquamarine M HF (202)	■
Black Diamond M HF (215)	■
Emerald M HF (205)	■
Jet M HF (280)	■
Light Colorado Topaz M HF (246)	■
Light Rose M HF (223)	■
Scarlet M HF (276)	■
Crystal Effects	
Transparent Effects	
Crystal Aurore Boreale M HF (001 AB)	■
Crystal Golden Shadow M HF (001 GSHA)	■

2303 Pear Flat Back

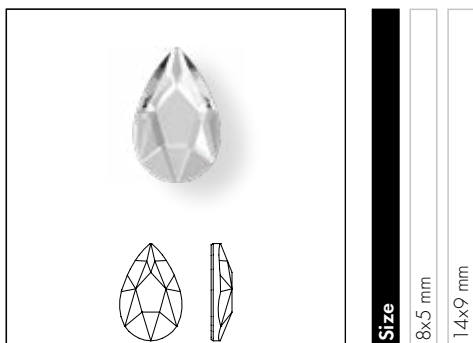

Size

8x5 mm

14x9 mm

Crystal

Crystal M HF (001)

Crystal Effects

Transparent Effects

Crystal Aurore Boreale M HF (001 AB)

Crystal Golden Shadow M HF (001 GSHA)

Crystal Heliotrope M HF (001 HEL)

Crystal Shimmer M HF (001 SHIM)

2304 Raindrop Flat Back

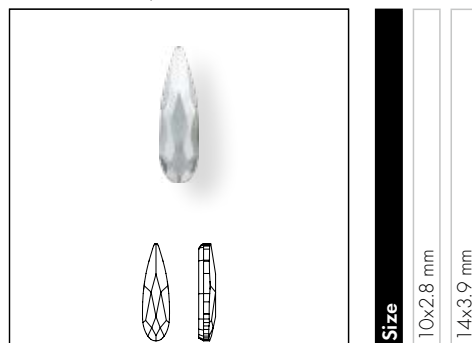

Size

10x2.8 mm

14x3.9 mm

Crystal

Crystal M HF (001)

Crystal Effects

Transparent Effects

Crystal Aurore Boreale M HF (001 AB)

Crystal Golden Shadow M HF (001 GSHA)

Crystal Heliotrope M HF (001 HEL)

Crystal Shimmer M HF (001 SHIM)

2400 Square Flat Back

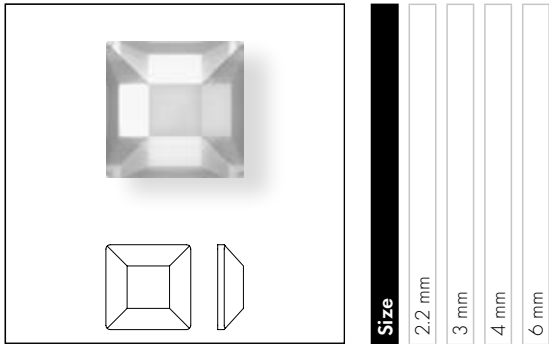

Size
2.2 mm
3 mm
4 mm
6 mm

Crystal	2.2 mm	3 mm	4 mm	6 mm
Crystal M HF (001)	■	■	■	■
Colors				
Plain Colors				
Amethyst M HF (204)		■	■	
Aquamarine M HF (202)		■	■	
Black Diamond M HF (215)		■	■	
Emerald M HF (205)		■	■	
Jet M HF (280)		■	■	■
Light Colorado Topaz M HF (246)		■	■	
Light Rose M HF (223)		■	■	
Scarlet M HF (276)		■	■	
ReCreated™ Colors				
ReCreated™ Dark Jonquil M HF (1407)		■	■	
ReCreated™ Light Smoked Topaz M HF (1402)		■	■	
ReCreated™ Peridot M HF (1408)		■	■	
ReCreated™ Smoked Topaz M HF (1403)		■	■	
TCF™ Colors				
Dark Orange M HF (1202 TCF™)		■	■	
Crystal Effects				
Transparent Effects				
Crystal Aurore Boreale M HF (001 AB)	■	■	■	■
Crystal Golden Shadow M HF (001 GSHA)	■	■	■	■
Crystal Heliotrope M HF (001 HEL)		■	■	
Crystal Shimmer M HF (001 SHIM)		■	■	
Crystal Silver Night M HF (001 SINI)		■	■	
Metallic Effects				
Crystal Aurum M HF (001 AUR)		■	■	
Color Effects				
Metallic Effects				
Jet Hematite M HF (280 HEM)		■	■	

2471 Cushion Flat Back

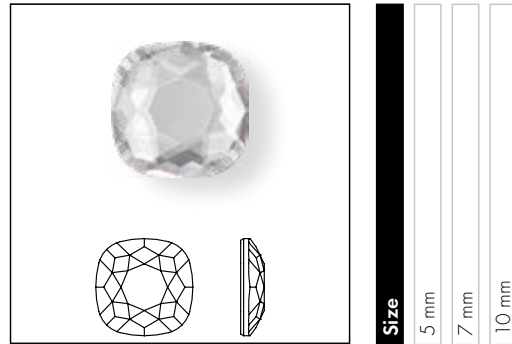

Size
5 mm
7 mm
10 mm

Crystal	5 mm	7 mm	10 mm
Crystal M HF (001)	■	■	■
Colors			
Plain Colors			
Aquamarine M HF (202)	■	■	■
Emerald M HF (205)	■	■	■
Graphite M HF (253)	■	■	■
Jet M HF (280)	■	■	■
Sapphire M HF (206)	■	■	■
Scarlet M HF (276)	■	■	■
Vintage Rose M HF (319)	■	■	■
Crystal Effects			
Transparent Effects			
Crystal Aurore Boreale M HF (001 AB)	■	■	■
Crystal Golden Shadow M HF (001 GSHA)	■	■	■

2472 Trilliant Flat Back

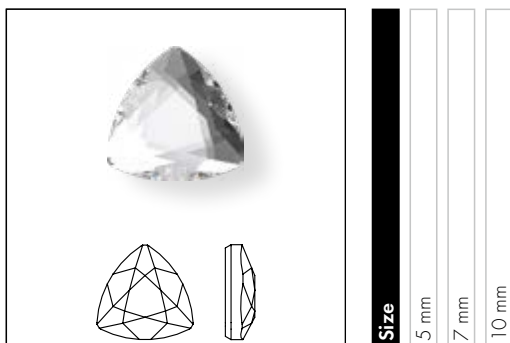

Size
5 mm
7 mm
10 mm

Crystal

Crystal M HF (001)

Colors

Plain Colors

Aquamarine M HF (202)

Emerald M HF (205)

Graphite M HF (253)

Jet M HF (280)

Sapphire M HF (206)

Scarlet M HF (276)

Vintage Rose M HF (319)

Crystal Effects

Transparent Effects

Crystal Aurore Boreale M HF (001 AB)

Crystal Golden Shadow M HF (001 GSHA)

2510 Baguette Flat Back

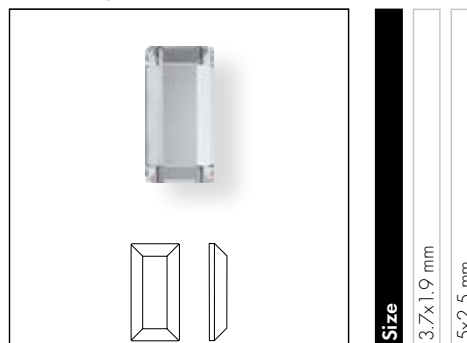

Size
3.7x1.9 mm
5x2.5 mm

Crystal

Crystal M HF (001)

Colors

Plain Colors

Aquamarine M HF (202)

Black Diamond M HF (215)

Emerald M HF (205)

Jet M HF (280)

Light Colorado Topaz M HF (246)

ReCreated™ Colors

ReCreated™ Dark Jonquil M HF (1407)

ReCreated™ Light Smoked Topaz M HF (1402)

ReCreated™ Peridot M HF (1408)

ReCreated™ Smoked Topaz M HF (1403)

TCF™ Colors

Dark Orange M HF (1202 TCF™)

Crystal Effects

Transparent Effects

Crystal Aurore Boreale M HF (001 AB)

Crystal Golden Shadow M HF (001 GSHA)

Crystal Heliotrope M HF (001 HEL)

Crystal Shimmer M HF (001 SHIM)

Metallic Effects

Crystal Aurum M HF (001 AUR)

2555 Cosmic Baguette Flat Back

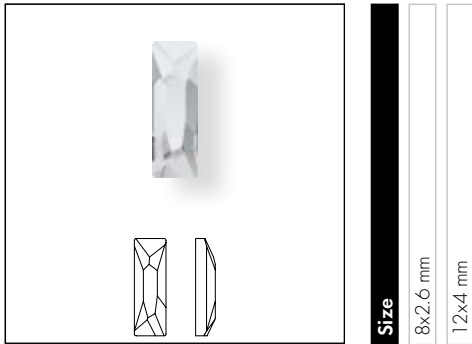

Size

8x2.6 mm

12x4 mm

Crystal

Crystal M HF (001)

Crystal Effects

Transparent Effects

Crystal Aurore Boreale M HF (001 AB)

Crystal Golden Shadow M HF (001 GSHA)

2602 Emerald Cut Flat Back

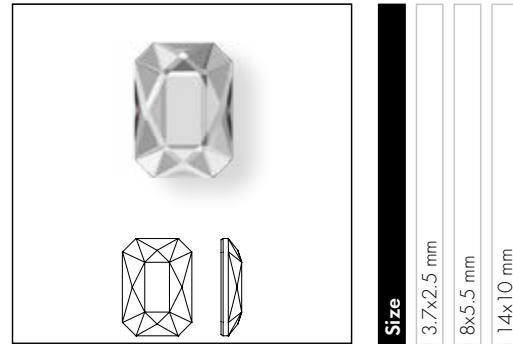

Size

3.7x2.5 mm

8x5.5 mm

14x10 mm

Crystal

Crystal M HF (001)

Colors

Plain Colors

Aquamarine M HF (202)

Emerald M HF (205)

Graphite M HF (253)

Jet M HF (280)

Sapphire M HF (206)

Scarlet M HF (276)

Vintage Rose M HF (319)

Crystal Effects

Transparent Effects

Crystal Aurore Boreale M HF (001 AB)

Crystal Golden Shadow M HF (001 GSHA)

Crystal Heliotrope M HF (001 HEL)

Crystal Shimmer M HF (001 SHIM)

2603 Oval Flat Back

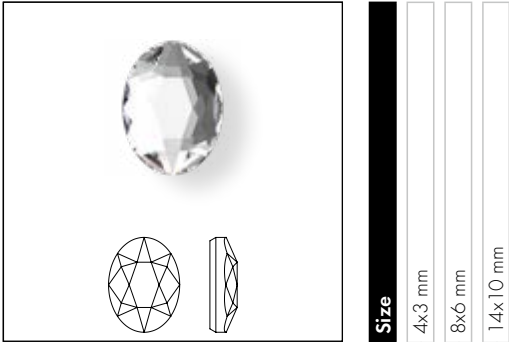

Size
4x3 mm
8x6 mm
14x10 mm

Crystal

Crystal M HF (001)

Colors

Plain Colors

Aquamarine M HF (202)

Emerald M HF (205)

Graphite M HF (253)

Jet M HF (280)

Sapphire M HF (206)

Scarlet M HF (276)

Vintage Rose M HF (319)

Crystal Effects

Transparent Effects

Crystal Aurore Boreale M HF (001 AB)

Crystal Golden Shadow M HF (001 GSHA)

2709 Rhombus Flat Back

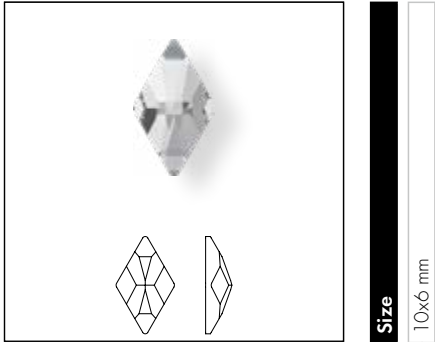

Size
10x6 mm

Crystal

Crystal M HF (001)

Crystal Effects

Transparent Effects

Crystal Aurore Boreale M HF (001 AB)

Crystal Golden Shadow M HF (001 GSHA)

2711 Triangle Flat Back

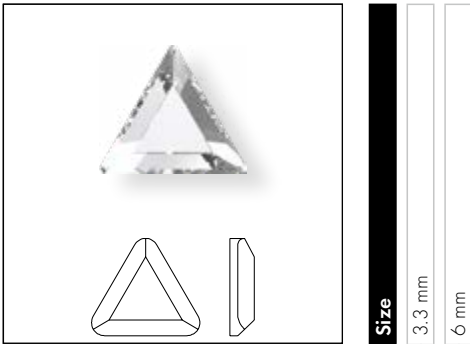

Crystal	
Crystal M HF (001)	
Colors	
Plain Colors	
Jet M HF (280)	
Crystal Effects	
Transparent Effects	
Crystal Aurore Boreale M HF (001 AB)	
Crystal Golden Shadow M HF (001 GSHA)	

2715 Connector Flat Back

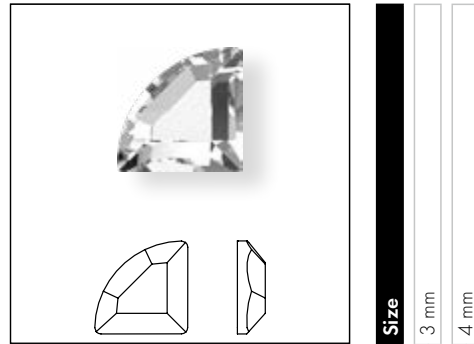

Crystal	
Crystal M HF (001)	
Colors	
Plain Colors	
Amethyst M HF (204)	
Aquamarine M HF (202)	
Emerald M HF (205)	
Jet M HF (280)	
Light Colorado Topaz M HF (246)	
Scarlet M HF (276)	
Crystal Effects	
Transparent Effects	
Crystal Aurore Boreale M HF (001 AB)	
Crystal Golden Shadow M HF (001 GSHA)	
Crystal Silver Night M HF (001 SINI)	
Metallic Effects	
Crystal Light Chrome M HF (001 LTCH)	
Color Effects	
Metallic Effects	
Jet Hematite M HF (280 HEM)	

TRIANGLE FAMILY

2738 Triangle Alpha Flat Back

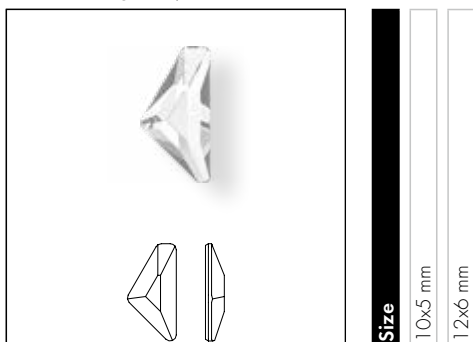

Size
10x5 mm
12x6 mm

- Crystal**
- Crystal M HF (001)
- Crystal Effects**
- Transparent Effects**
- Crystal Aurore Boreale M HF (001 AB)
- Crystal Golden Shadow M HF (001 GSHA)
- Crystal Silver Night M HF (001 SINI)

2739 Triangle Beta Flat Back



Size
5.8x5.3 mm
7x6.5 mm

- Crystal**
- Crystal M HF (001)
- Crystal Effects**
- Transparent Effects**
- Crystal Aurore Boreale M HF (001 AB)
- Crystal Golden Shadow M HF (001 GSHA)
- Crystal Silver Night M HF (001 SINI)

2740 Triangle Gamma Flat Back

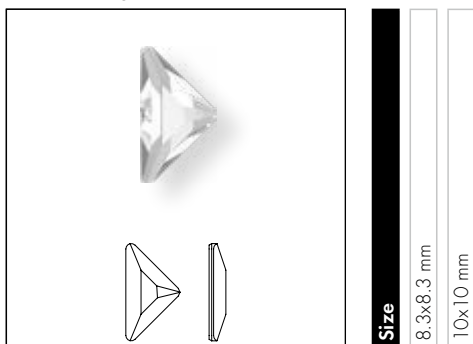

Size
8.3x8.3 mm
10x10 mm

- Crystal**
- Crystal M HF (001)
- Crystal Effects**
- Transparent Effects**
- Crystal Aurore Boreale M HF (001 AB)
- Crystal Golden Shadow M HF (001 GSHA)
- Crystal Silver Night M HF (001 SINI)

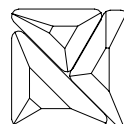

When Alpha, Beta, and Gamma Flat Backs are arranged together, they form a square.

2754 Star Flower Flat Back HF

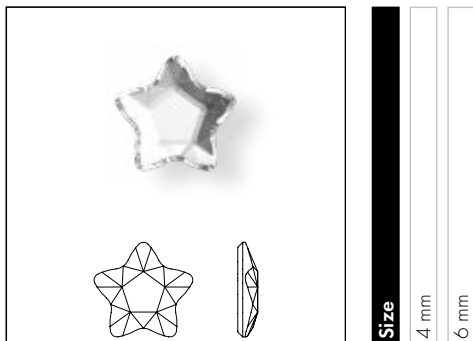

Size
4 mm
6 mm

Crystal		
Crystal M HF (001)	■	■
Colors		
Plain Colors		
Amethyst M HF (204)	■	■
Aquamarine M HF (202)	■	■
Iris M HF (219)	■	■
Jet M HF (280)	■	■
Light Rose M HF (223)	■	■
Light Topaz M HF (226)	■	■
Rose M HF (209)	■	■
Scarlet M HF (276)	■	■
ReCreated™ Colors		
ReCreated™ Peridot M HF (1408)	■	■
TCF™ Colors		
Dark Rose M HF (1201 TCF™)	■	■
Crystal Effects		
Transparent Effects		
Crystal Aurore Boreale M HF (001 AB)	■	■
Crystal Golden Shadow M HF (001 GSHA)	■	■

2770 Wing Flat Back

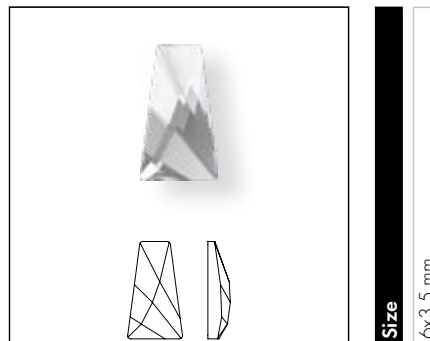

Size
6x3.5 mm

Crystal	
Crystal M HF (001)	■
Crystal Effects	
Transparent Effects	
Crystal Aurore Boreale M HF (001 AB)	■

2771 Kite Flat Back

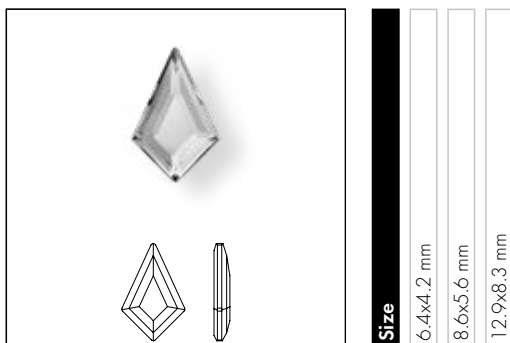

Size

6.4x4.2 mm
8.6x5.6 mm
12.9x8.3 mm

Crystal

Crystal M HF (001)

Colors

Plain Colors

Black Diamond M HF (215)

Light Rose M HF (223)

Light Siam M HF (227)

Crystal Effects

Transparent Effects

Crystal Aurore Boreale M HF (001 AB)

Crystal Golden Shadow M HF (001 GSHA)

Crystal Shimmer M HF (001 SHIM)

Color Effects

Metallic Effects

Jet Hematite M HF (280 HEM)

2772 Trapeze Flat Back

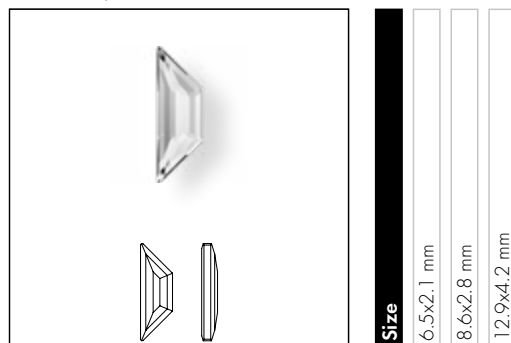

Size

6.5x2.1 mm
8.6x2.8 mm
12.9x4.2 mm

Crystal

Crystal M HF (001)

Colors

Plain Colors

Black Diamond M HF (215)

Crystal Effects

Transparent Effects

Crystal Aurore Boreale M HF (001 AB)

Crystal Golden Shadow M HF (001 GSHA)

Color Effects

Metallic Effects

Jet Hematite M HF (280 HEM)

2773 Diamond Shape Flat Back

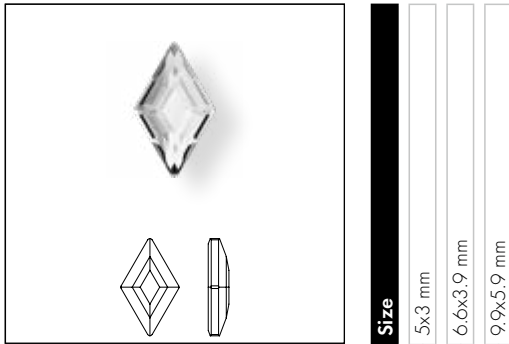

Crystal	5x3 mm	6.6x3.9 mm	9.9x5.9 mm
Crystal M HF (001)	■	■	■
Colors			
Plain Colors			
Black Diamond M HF (215)	■	■	■
Light Rose M HF (223)	■	■	■
Light Siam M HF (227)	■	■	■
Crystal Effects			
Transparent Effects			
Crystal Aurore Boreale M HF (001 AB)	■	■	■
Crystal Golden Shadow M HF (001 GSHA)	■	■	■
Crystal Shimmer M HF (001 SHIM)	■	■	
Color Effects			
Metallic Effects			
Jet Hematite M HF (280 HEM)	■	■	■

2774 Elongated Pentagon Flat Back

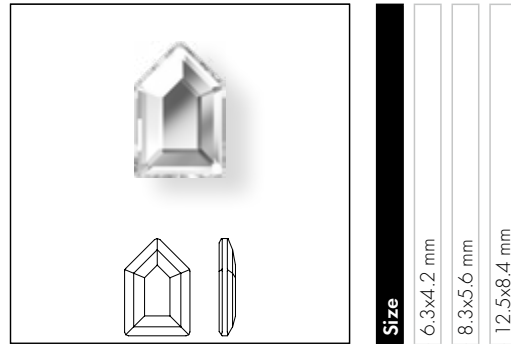

Crystal	6.3x4.2 mm	8.3x5.6 mm	12.5x8.4 mm
Crystal M HF (001)	■	■	■
Colors			
Plain Colors			
Black Diamond M HF (215)	■		
Light Siam M HF (227)	■		
Crystal Effects			
Transparent Effects			
Crystal Aurore Boreale M HF (001 AB)	■	■	■
Color Effects			
Metallic Effects			
Jet Hematite M HF (280 HEM)	■		

2775 Concise Pentagon Flat Back

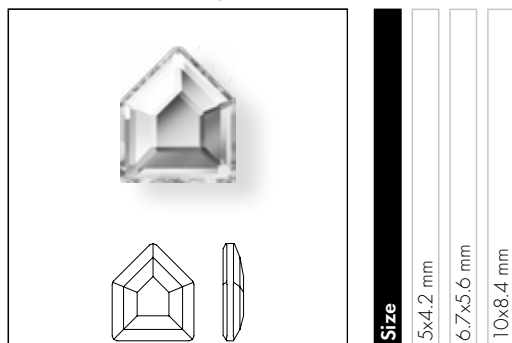

Size

5x4.2 mm

6.7x5.6 mm

10x8.4 mm

Crystal

Crystal M HF (001)

Colors

Plain Colors

Black Diamond M HF (215)

Light Siam M HF (227)

Crystal Effects

Transparent Effects

Crystal Aurore Boreale M HF (001 AB)

Color Effects

Metallic Effects

Jet Hematite M HF (280 HEM)

2776 Elongated Hexagon Flat Back

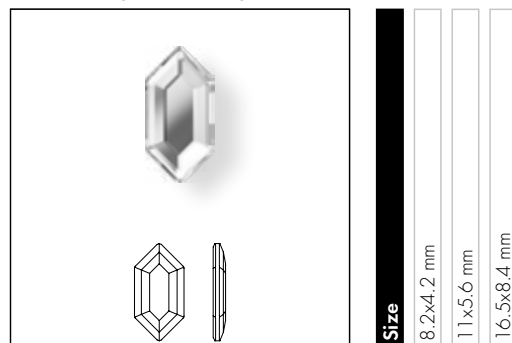

Size

8.2x4.2 mm

11x5.6 mm

16.5x8.4 mm

Crystal

Crystal M HF (001)

Colors

Plain Colors

Black Diamond M HF (215)

Light Siam M HF (227)

Crystal Effects

Transparent Effects

Crystal Aurore Boreale M HF (001 AB)

Color Effects

Metallic Effects

Jet Hematite M HF (280 HEM)

2777 Concise Hexagon Flat Back

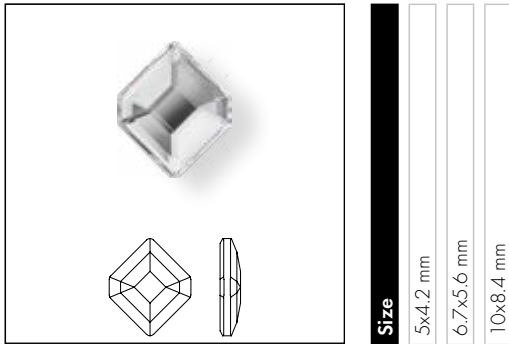

Size
5x4.2 mm
6.7x5.6 mm
10x8.4 mm

- Crystal**
- Crystal M HF (001)
- Colors**
- Plain Colors**
- Black Diamond M HF (215)
- Light Siam M HF (227)
- Crystal Effects**
- Transparent Effects**
- Crystal Aurore Boreale M HF (001 AB)
- Color Effects**
- Metallic Effects**
- Jet Hematite M HF (280 HEM)

2808 Heart Flat Back

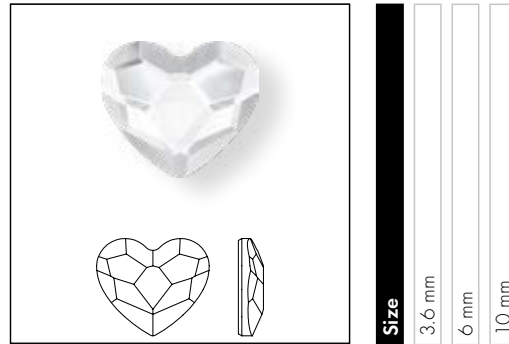

Size
3.6 mm
6 mm
10 mm

- Crystal**
- Crystal M HF (001)
- Colors**
- Plain Colors**
- Fuchsia M HF (502)
- Jet M HF (280)
- Light Siam M HF (227)
- TCF™ Colors**
- Dark Rose M HF (1201)
- Crystal Effects**
- Transparent Effects**
- Crystal Aurore Boreale M HF (001 AB)
- Crystal Golden Shadow M HF (001 GSHA)

2788 Wave Flat Back



Size
8 mm

- Crystal**
- Crystal M HF (001)
- Crystal Effects**
- Transparent Effects**
- Crystal Aurore Boreale M HF (001 AB)

2813 Moon Flat Back Hotfix

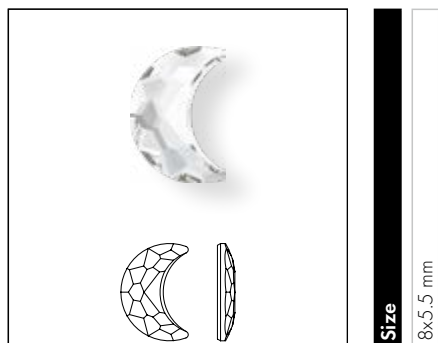

Crystal

Crystal M HF (001)

Crystal Effects

Transparent Effects

Crystal Aurore Boreale M HF (001 AB)

2816 Rivoli Star Flat Back

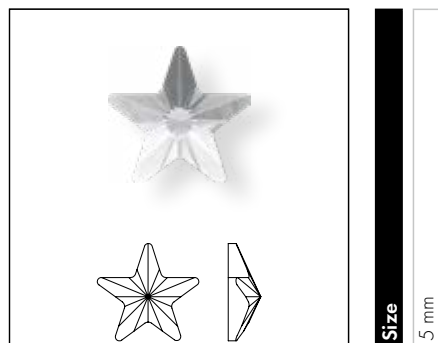

Crystal

Crystal M HF (001)

Colors

Plain Colors

Jet M HF (280)

Crystal Effects

Transparent Effects

Crystal Aurore Boreale M HF (001 AB)

Color Effects

Metallic Effects

Jet Hematite M HF (280 HEM)

Product Details

Article Size	Packing Unit = Minimum Order Quantity in Pieces	Average Net Weight in Gram per Packing Unit Crystal (001)	Average Gross Weight in Gram per Packing Unit Crystal (001)
1098 A HF			
PP 24 (SS 12)	1440	20.96	31.16
PP 31 (SS 16)	1440	41.13	51.33
SS 20	720	36.58	46.78
2000 A HF			
SS 3	1,440	1.8	12.7
2038 A HF			
SS 5	1,440	4.2	12.1
SS 6	1,440	5.4	17.7
SS 8	1,440	9.96	18.2
SS 10	1,440	15.54	24.3
2038/1			
SS 10	1440	15.7	24.4
2078 A HF			
SS 12	1,440	21.6	30.4
SS 16	1,440	39.1	47.1
SS 20	1,440	72.0	79.6
SS 30	288	34.6	63.0
SS 34	144	26.0	48.6
SS 40	144	43.2	66.9
SS 48	96	61.4	87.4
2078/1 A HF			
SS 16	1,440	39.1	47.1
SS 20	1,440	72.0	79.6
2080/4 HF			
SS 6	1,440	6.5	16.7
SS 10	1,440	17.1	28.3
SS 16	1,440	43.4	54.9
SS 20	1,440	82.9	93.1
SS 34	144	23.2	34.1
2100 M HF			
SS 12	1,440	22.1	32.3
SS 16	1,440	34.1	44.3
SS 20	1,440	67.5	77.7
SS 30	288	33.5	56.7
SS 34	144	22.5	47.6
SS 40	144	34.0	59.1
SS 48	96	47.1	70.9
2200 M HF			
4x2 mm	720	6.5	18.5
8x4 mm	360	24.8	35.8
2201 M HF			
4x1.8 mm	720	5.7	15.9
8x3.5 mm	144	10.03	31.11
14x6 mm	72	21.67	45.27

Article Size	Packing Unit = Minimum Order Quantity in Pieces	Average Net Weight in Gram per Packing Unit Crystal (001)	Average Gross Weight in Gram per Packing Unit Crystal (001)
2205 M HF			
7.5 mm	288	20.3	30.5
10 mm	144	17.6	42.4
14 mm	72	22.3	45.9
2300 M HF			
8x4.8 mm	360	41.9	51.0
2303 M HF			
8x5 mm	144	15.70	39.60
14x9 mm	72	36.65	60.25
2304 M HF			
10x2.8 mm	180	10.2	20.4
14x3.9 mm	96	13.1	36.3
2400 M HF			
2.2 mm	1,440	9.65	18.5
3 mm	1,440	25.3	36.8
4 mm	720	30.0	41.0
6 mm	144	21.9	32.7
2471 M HF			
5 mm	288	17.3	25.6
7 mm	72	11.9	35.1
10 mm	72	30.2	51.6
2472 M HF			
5 mm	288	17.4	27.6
7 mm	144	20.8	42.8
10 mm	96	34.5	56.5
2510 M HF			
3.7x1.9 mm	720	8.2	10.6
5x2.5 mm	720	23.2	32.3
2555 M HF			
8x2.6 mm	240	18.4	27.5
12x4 mm	144	28.8	33.6
2602 M HF			
3.7x2.5 mm	720	11.5	21.7
8x5.5 mm	144	17.89	41.79
14x10 mm	72	58.61	82.21
2603 M HF			
4x3 mm	288	6.8	17.0
8x6 mm	144	21.7	43.7
14x10 mm	72	50.3	72.3
2709 M HF			
10x6 mm	288	28.9	67.2
2711 M HF			
3.3 mm	720	6.38	15.63
6 mm	360	29.7	40.7

Article Size	Packing Unit = Minimum Order Quantity in Pieces	Average Net Weight in Gram per Packing Unit Crystal (001)	Average Gross Weight in Gram per Packing Unit Crystal (001)
2715 M HF			
3 mm	288	4.0	14.2
4 mm	288	8.2	18.4
2716 M HF			
5 mm	720	35.8	75.1
2738 M HF			
10x5 mm	144	16.7	35.1
12x6 mm	96	20.2	38.3
2739 M HF			
5.8x5.3 mm	216	19.2	41.9
7x6.5 mm	144	22.6	39.8
2740 M HF			
8.3x8.3 mm	216	35.1	54.2
10x10 mm	96	25.1	41.1
2754 M HF			
4 mm	720	13.6	23.8
6 mm	360	20.5	30.7
2770 M HF			
6x3.5 mm	1,440	60.3	70.3
2771 M HF			
6.4x4.2 mm	288	9.04	17.87
8.6x5.6 mm	216	16.84	43.02
12.9x8.3 mm	144	36.29	61.39
2772 M HF			
6.5x2.1 mm	288	6.39	15.17
8.6x2.8 mm	288	16.29	40.71
12.9x4.2 mm	144	25.57	53.86
2773 M HF			
5x3 mm	288	4.83	13.66
6.6x3.9 mm	288	11.23	35.65
9.9x5.9 mm	144	19.30	43.39
2774 M HF			
6.3x4.2 mm	288	18.7	29.6
8.3x5.6 mm	144	19.5	39.4
12.5x8.4 mm	96	39.0	60.3
2775 M HF			
5x4.2 mm	288	13.9	24.7
6.7x5.6 mm	144	15.0	34.3
10x8.4 mm	144	43.6	66.4
2776 M HF			
8.2x4.2 mm	144	11.2	30.1
11x5.6 mm	72	11.3	28.8
16.5x8.4 mm	72	35.6	55.8

Article Size	Packing Unit = Minimum Order Quantity in Pieces	Average Net Weight in Gram per Packing Unit Crystal (001)	Average Gross Weight in Gram per Packing Unit Crystal (001)
2777 M HF			
5x4.2 mm	288	10.4	21.3
6.7x5.6 mm	144	10.5	29.7
10x8.4 mm	144	32.8	52.7
2788 M HF			
8 mm	288	7.5	18.4
2808 M HF			
3.6 mm	720	18.4	20.8
6 mm	288	19.8	28.9
10 mm	144	38.8	55.9
2813 M HF			
8x5.5 mm	144	13.1	37.7
2816 M HF			
5 mm	720	23.6	30.7