

Swarovski Components Collection

Contents

23 BASIC INFORMATION

- 24 Key Facts
- 27 Colors & Effects Overview

33 CARE INSTRUCTIONS

42 01 ROUND STONES

- 44 Colors & Effects
- 47 Summary
- 55 Product Details

58 02 FLAT BACKS NO HOTFIX

- 60 Colors & Effects
- 64 Summary
- 90 Product Details

94 03 FLAT BACKS HOTFIX

- 96 Colors & Effects
- 101 Summary
- 126 Product Details

130 04 SEW-ON ARTICLES & CRYSTAL BUTTONS

- 132 Colors & Effects

133 Sew-on Articles

- 134 Summary
- 143 Product Details

145 Crystal Buttons

- 146 Summary
- 148 Product Details

150 05 FANCY STONES

- 152 Colors & Effects
- 155 Summary
- 185 Product Details

190 06 BEADS

- 192 Colors & Effects
- 196 Summary
- 212 Product Details

214 07 CRYSTAL PEARLS

- 216 Colors
- 218 Summary
- 219 Ordering Example & Product Variety Explanation
- 227 Product Details

228 08 PENDANTS

- 230 Colors & Effects
- 233 Summary
- 256 Product Details

260 09 CRYSTAL TRANSFERS

- 262 Overview of Flat Backs Hotfix for Crystal Transfers
- 264 Metallics

265 Crystal Transfers and Inspirational Motifs

- 268 Special Motif Service

269 Crystal-it Infinity

- 271 Flat Backs for Crystal-it Infinity
- 274 Inspirational Motifs
- 275 Special Motif Service

DISCLAIMER “CRYSTAL”

The material manufactured by Swarovski is considered as “crystal glass”, category 3, in accordance with European Council Directive 69/493 on the approximation of the laws of the Member States relating to crystal glass. Whenever referring to “crystal” in this document, Swarovski either refers to a singular component or product made of crystal glass, or the material crystal glass.

276 10 CRYSTAL TEXTURES

- 278 Crystal Texture Product Overview
- 279 Crystal Texture Special Features Overview
- 280 Crystal Textures Products & Fields of Application

283 Crystal Fabric Family

- 284 Crystal Fabric Bandings**
- 285 Crystal Fabric Motifs**
- 286 Colors & Effects
- 289 Inspirational Motifs
- 290 Technical Product Information

291 Crystal Intarsia

- 297 Inspirational Motifs
- 298 Technical Product Information

299 Crystal Rocks Family

- 303 Colors & Effects
- 308 Inspirational Motifs
- 309 Technical Product Information

311 Crystaltex Chaton Bandings**315 Additional Features****316 Graphic – The Limitless Crystal Printing Technology**

- 318 Colors & Effects
- 319 Inspirational Motifs
- 319 Graphic Fabric
- 319 Graphic Crystal Intarsia
- 320 Graphic Crystal Rocks Family

321 Unlimited Technology**323 Foil Overlay Technology**

- 324 Inspirational Motifs

325 Special Motif Service**328 11 LINKED CRYSTAL COMPONENTS****331 Crystal Mesh**

- 332 Product Overview
- 334 Crystal Mesh Standard**
- 338 Crystal Mesh Standard Mini**
- 342 Crystal Fine Mesh**

347 Crystal Mesh Motifs

- 349 Special Motif Service
- 350 Inspirational Motifs

353 Crystal Honeycomb Mesh

- 356 Crystal Light Mesh & Crystal Light Mesh Mini**
- 361 Crystal Mesh Colorée & Crystal Mesh Colorée Mini**
- 366 Crystal Caviar Mesh**
- 370 Product Details

371 Cupchains

- 372 Product Overview
- 373 Round Cupchain**
- 376 Round Extended Cupchain**
- 380 Snake Chain**
- 383 Baguette Chain**
- 386 Round Solitaire Cupchain**
- 390 Catch Free Chain**
- 393 Bezel Chain**
- 396 Square Chain**
- 399 Multi-Row Cupchain**
- 403 Special Motif Service
- 404 Cupchains Inspirational Motifs

406 12 CRYSTAL RIVETS & ROSE PINS**408 Crystal Rivets**

- 411 Tools for Fly Press
- 412 Back Parts for Rivets

413 Rose Pins

- 414 Tools for Fly Press

418 13 APPLICATION TOOLS**420 Crystal Glues CG 500 (A+B) & CG 610 (A+B)**

- 420 Available Packaging Versions
- 422 Gluing Tools
- 423 Mechanical Tools
- 424 Tools for Rivets
- 425 Tools for Rose Pins
- 426 Hotfix Application Tools

427 Table of Sizes



A Spark of Brilliance: The Swarovski Story

In 1895, Daniel Swarovski forever changed the fashion and jewelry industries with the introduction of his mesmerizing, precision-cut crystals.

An inventor, an engineer, but above all, a visionary, Swarovski was captivated by the immense potential of electricity. In 1892, he patented the first electricity-powered cutting machine – an innovation that transformed an industry at a time when crystals were all cut by hand.

This burgeoning new business needed a location beyond the borders of Bohemia. With partners Franz Weis and Armand Kosmann, Swarovski found it in Wattens. A picturesque village nestled in the Austrian Alps. The location offered strategic advantages: a safe distance from imitators, a transport link to the fashion capitals of Paris and Milan and, crucially, an abundant water supply to generate the hydroelectric power his machine required.

The future was set in motion, and the Swarovski legacy began. Driven by Daniel Swarovski's unyielding passion for innovation and design, the brand grew into a global symbol of brilliance. Today, the brand Swarovski continues to honor his vision, bringing unparalleled sparkle and style to admirers around the world.



Sparkling Creativity

Swarovski doesn't just create crystals – we define them. From the first spark of inspiration to the final collection, the brand's creative process is exacting and brilliantly uncompromising to ensure our partners receive the very best. Every step from trend curation, design innovation, and brand storytelling embodies more than 130 years of technical mastery and unparalleled expertise in cutting crystals, Zirconia and Ceramics.

Through a long history of partnering with the world's most esteemed artists, luxury brands, and prestigious fashion houses, our crystals are constantly transformed into style moments. Iconic and individual, every radiant Swarovski piece tells its own illuminating story, leaving us continuously held spellbound by the splendor our crystals achieve in the hands of the world's most renowned artisans.

Craftsmanship Meets Imagination

Over 130 years ago, Daniel Swarovski set out with a clear vision: to create “a diamond for everyone.” This revolutionary idea of placing our clients front and center redefined the future of crystals and still holds true today, with innovation and imagination remaining at the heart of everything we do.

From our historic headquarters in Austria, we continually explore new cuts, colors, and sizes, pushing the limits of possibility with pioneering state-of-the-art innovations. Tireless in our pursuit of the new and next, to ensure you remain one step ahead, every piece is the result of exceptional savoir-faire and in-depth know-how. Renowned for our remarkable clarity and radiance, this mastery in crafting and shaping crystals allows us to offer an unparalleled assortment in the industry, with crystals that are as future-focused as they are timeless.



Art. 1



Art. 2



Art. 3/I



72



Art. 4



56



Art. 5

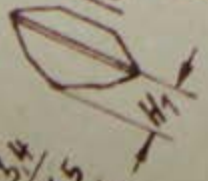

56

ϕ	$H/2$
5	22
6	24
7	27
8	29
9	31
10	33
11	34
12	35
13	36
14	37



Made to Order – Style Without Limits

We understand that your individuality makes you shine – and for us, that is the ultimate luxury. Our Customized Color and Effect Service, a merging of both Crystal Components and Forward Integrated Elements, is designed to extend your unique artistic expression, especially crafted to allow you to reflect your personal vision and style.

With a range of over 100 hues, effects, and lacquer combinations, our color assortment offers endless possibilities. For those seeking something truly distinctive, our bespoke mix-and-match options allow you to create statement components, ensuring luminous design is easily within reach.

Beyond color, we offer tailored solutions in shapes, sizes, logos, and motif variations, ensuring every detail corresponds with your creative direction. For access to these exclusive services, please get in touch with us at Swarovski.



Shaping a Brighter Future

Swarovski has always been committed to creating a more brilliant future – for people and for the planet. Since our founding in 1895, sustainability has been woven into our DNA, extending far beyond our pioneering crystal-cutting techniques. From the beginning Daniel Swarovski championed progressive social initiatives – providing housing for workers, building a local school, and ensuring their health, safety, and wellbeing. His visionary principles of fairness – toward both communities and the environment – still shape our business today.

Long before sustainability and renewable energy became global priorities, these values were already at the heart of Swarovski's vision. From the outset, Daniel Swarovski employed hydroelectric power to drive his revolutionary crystal-cutting process in Wattens, Austria. In 1907, we built our own hydroelectric power plant in Wattens – with a capacity of 600 HP – which began operating that December, fueling Swarovski's innovative spirit.

Our goal has always been to be known as a brand that acts with purpose – championing circular innovation and celebrating individuality. This means making conscious choices that create lasting value for people, communities, the natural world, and our business alike.

Since those visionary early days, sustainability has remained a core commitment. We have always set ambitious, long-term goals – leveraging our renowned savoir-faire to drive innovation and embed sustainability across every aspect of our business: from clean energy commitments to future product development, from concept to store.

Our sustainability strategy focuses on three priority areas:

- **Mitigate Climate change:** We mitigate climate change by focusing on increased energy efficiencies and a greater share of renewables in our own facilities (Scope 1 & 2) and throughout the entire supply chain (Scope 3)
- **Preserve resources and minimize waste:** We create future-fit materials through innovation, without sacrificing quality or aesthetics and accelerate circularity to preserve resources and extend product life. We streamline operations by closing loops and minimizing waste.
- **Promote fairness and celebrate individuality:** We respect and protect the rights of everyone in our value chain, ensuring fair employment conditions as per International Labour Organization’s (ILO) Core Conventions and UN Guiding Principles. We champion equity, diversity, and inclusion across our organization, value chain, and customer experience.

From strategy to action, we continue to deliver on our commitment to shape a more sustainable future.

We are also making efforts to actively reduce our greenhouse gas emissions through energy efficiencies and the transition to renewable energy. Five out of our six manufacturing sites now operate using 100% renewable electricity, which also involves a large-scale photovoltaic plant at our headquarters in Wattens. With the purpose of advancing electrification in production we have installed an innovative 100% electric crystal furnace at our Wattens site. Concurrently, we are working toward transforming our operations to be 90% landfill-free by 2030, reflecting our commitment to a sustainable future.

We are continually making progress to increase the sustainability credentials of our products including responsibly sourced and recycled raw materials. Our Swarovski ReCreated™ crystals, first launched in 2023, transform glass production breakage into vibrant crystals that uphold the same high standards of quality as our traditional Swarovski crystals, while using at least 40% fewer natural resources – making them our most sustainable crystals to date. Swarovski Zirconia is created using renewable electricity for the most energy-intensive stage of processing. As a result, 77% of the electricity used for the production of our Swarovski Zirconia comes from renewable sources.

At Swarovski, we strive to be recognized as a brand that champions diversity and celebrates individuality, creating a welcoming and safe environment for everyone in our business and in society. We recognize that the actions and well-being of our employees directly influence our impact on society. That’s why we provide extensive learning opportunities, awareness workshops, and a range of initiatives to support our teams globally.

Achieving Swarovski’s unparalleled mastery of light is a complex, global endeavor. Ensuring that our extraordinary savoir-faire is delivered sustainably requires the expertise and dedication of our people, coupled with transformative initiatives that reach into every corner of the world.

Precision and Responsibility Since 1895

Swarovski has always championed fairness and sustainability, giving our partners complete confidence in the integrity of every creation. Every one of our crystals reflects our commitment to quality, ethical standards, and environmental responsibility, with our long-term sustainability strategy part of the very fabric of our business.

We guarantee:

- OEKO-TEX® Standard 100 certification for direct skin contact*
- Lead-free, chrome-free, and arsenic-free crystals **
- **ISO 9001, ISO 14001, ISO 45001, ISO 50001** and SMETA certifications at our Wattens, Austria headquarters

With a fully integrated supply chain and exacting standards, Swarovski delivers consistent quality while helping customers meet their sustainability goals.

* Excludes select colors no longer available in the standard assortment.

** No intentionally added lead, lead content 40ppm or lower. No intentionally added Chrome, Chrome content 100ppm or lower. No intentionally added Arsenic.

Creating Color with Purpose

Swarovski's patented TCF™ collection showcases our commitment to sustainable innovation. Developed through a cradle-to-gate Life Cycle Assessment, this breakthrough achieves a 69% Lower Resource Use footprint* compared to our conventional crystal coloring processes.

The new Dark Orange THERMAL COLOR FUSION color also shows a 38% Lower Environmental Footprint*, while maintaining the quality and brilliance synonymous with Swarovski, demonstrating that luxury and responsibility definitely shine together.

* According to a cradle to gate ISO 14040-conform screening Life Cycle Assessment using the EU-PEF method, performed by external agency Quantis.

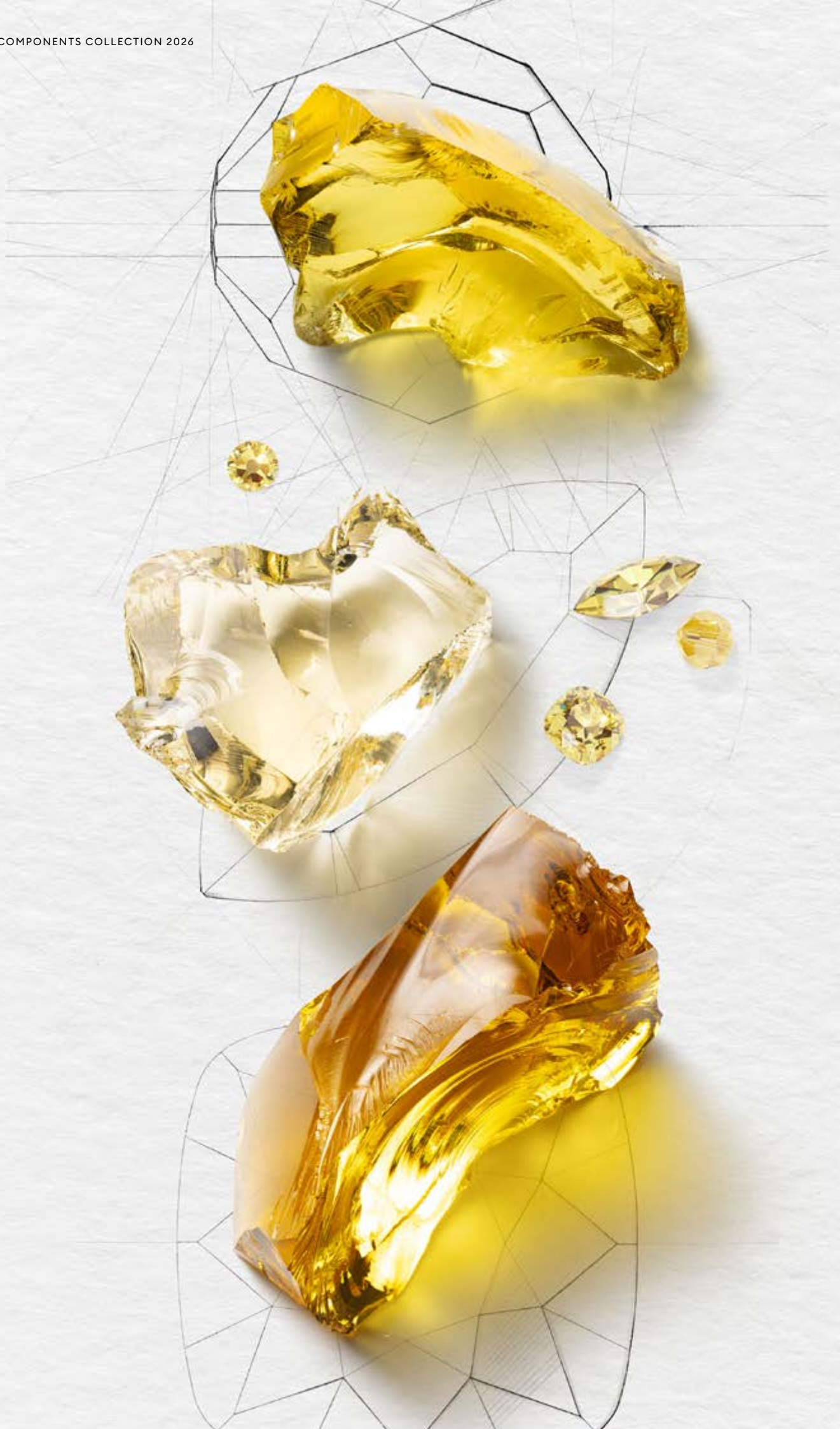

Swarovski ReCreated™ Crystals – Dazzling by Design

Sustainability has always been central to our brand, a core and enduring value we are proud to share with our partners. Our most sustainable crystals to date, Swarovski ReCreated™ crystals, unite our legendary savoir-faire with a bold approach to circular innovation. Crafted from breakage generated during our manufacturing process, these crystals are transformed into entirely new creations – forming fresh colors, each developed according to its own unique recipe to guarantee perfect color consistency, without compromising on the exacting quality that defines Swarovski.

By reimagining production breakage, Swarovski ReCreated™ crystals maintain the same distinguished standards as all Swarovski crystals, while using at least 40% fewer natural resources. This innovation reduces the crystals' environmental footprint by at least 34%, proving that responsible luxury has never shone brighter.

And this is just the beginning – our story of sustainable innovation continues to evolve, with even more exciting chapters yet to come.

- * Calculations are based on ISO compliant crystal glass LCA. Calculation compares crystal glass of 100% raw material with crystal glass of 50% glass breakage/50% raw material. LCA is cradle to gate (factory gate, no distribution). The minimum glass breakage is 50%. This leads to the (minimum) 34% lower environmental footprint. The environmental footprint takes into account all 16 environmental indicators of the ISO 14040.
- ** “Natural resources”, more specifically “resource use/depletion (minerals and metals)” is one of the 16 environmental indicators of the ISO compliant crystal glass LCA. This indicator has the highest impact (of the 16), as we replace virgin raw material with (secondary) glass breakage.



Crafting Memories through Color

Color is far more than an aesthetic – it’s a language to communicate, inspire, and transform. We understand that this is your way to express yourself and make an impact. That’s why our crystals capture the perfect interplay of hue and light. Like you, we aim to turn crystals into creations that evoke emotion, elevate design, and create unforgettable experiences. Every Swarovski shade is meticulously crafted, blending technical expertise with personal expression, to ensure each and every one of our crystals conveys their own unique story.

With an extensive palette of colors and effects – available as single shades or carefully curated combinations – our partners can bring their creative vision to life, designing pieces that reflect their individuality. From the softest pastels to the most dazzling jewel tones, Swarovski perfects the power of color to create moments that connect people, transform spaces, and define individuality. Through color, together we shape the way we experience the world – shifting moods, sparking memories, and inspiring creativity.

With the 1956 debut of the iconic Aurora Borealis effect – renowned for its sparkling rainbow hues and first showcased by Haute Couture legend Christian Dior – to the introduction of our protected TCF™ technology with its lower resource footprint, and daring fashion-forward Lacquers we continually push creative boundaries. The legacy shines on with Crystal Aurum, infused with real 18k gold, and our ever-present spectrum of elevated crystal colors, as we continue to redefine brilliance.

With every shining facet, Swarovski shows that color is not just seen – it is experienced, lived, and remembered, transforming crystals into an enduring canvas for creativity.

Classic Colors: Offering an unparalleled variety of shades, each crystal is fully colored by adding pigments to the base raw material, ensuring the crystals take on a uniformly consistent hue.

Swarovski ReCreated™ Crystals: Our most sustainable crystals are crafted using at least 50% glass breakage. The entire crystal is fully colored in an eco-friendly process, making them our most environmentally conscious creations to date.

TCF™: Thermal Color Fusion is a cutting-edge technology that enhances the crystals with an enduring hard layer on the pavilion. It opens up endless made-to-order possibilities, with lower minimum orders and flawless, consistent color.

Effects: Effects are achieved through physical vaporization, applying a metallic coating under a vacuum. Since the crystal is only partially colored on the surface it offers greater flexibility and consistency in color.

Lacquer^{PRO}: Our fashion-forward lacquer colors are created using an opaque varnish applied to the reverse side of each component. Combined with an effect applied to the front or back, they hold a uniquely dynamic appeal.



Swarovski Pearls – An Ode to Subtle Radiance

The Swarovski Crystal Pearl journey is a story of innovation, artistry, and timeless elegance. It began in the 1960s with the creation of the first imitation pearls, with a core crafted from alabaster glass and finished with a spray-painted coating. By 1966, the first sample chart had been developed, establishing a consistent approach to color and finish, and in 1967, the iconic “Maharani Imitation Pearls” were registered, marking the first milestones in a long tradition of luminous innovation.

Shimmering with sophistication, Swarovski Crystal Pearls embody the brand’s heritage of craftsmanship and creative evolution, as well as our dedication to continually inspire and delight our partners. Each Swarovski Crystal Pearl is centered with a core of light-reflecting crystals and an outer finish of Swarovski’s signature pearl coating, mimicking the radiance of real pearls. So aligned are our imitation pearls with the natural order, that the lustrous surface and silky texture respond to the warmth of the skin.

In 2000, Swarovski Crystal Pearls were introduced as a product directly inspired by

nature and crafted with unparalleled savoir-faire. Cementing our place at the forefront of innovative artistry lies our uncompromising commitment to quality and sustainability: Swarovski Crystal Pearls are Oeko-Tex 100 certified for direct skin contact, produced with our lead-free Advanced Crystal formula, and guaranteed free of chrome and arsenic.

Further preserving our prestige, in 2025 the globally renowned Gemological Institute of America (GIA) conducted a comprehensive quality review concluding that Swarovski Crystal Pearls exhibit exceptional quality, with a realistic and appealing appearance, weight, and feel. Summarizing that each strand and color group demonstrated remarkable consistency, exhibiting bright reflections and notable depth.

Crafted at our headquarters in Wattens, Austria, every Swarovski Crystal Pearl is a testament to artistry, precision, and enduring quality – offering our esteemed partners consistency across a wide range of shapes, sizes, colors, and effects to bring any design to life.



Partners in Perfection

Since 1895, our visionary designs and precision craftsmanship have set the global standard for crystals. To this day, we continually ensure our partners gain access to exceptional detail, innovative designs, and a legacy of radiance that elevates every creation.

The brilliance protected designs of our XIRIUS and XILION crystals, together with our patented TCF™ technology and Swarovski ReCreated™ crystals, ensure our innovations remain exclusive and giving our partners complete confidence in the authenticity of every creation.

Partnering with Swarovski means joining over 130 years of unmatched craftsmanship and innovation. We understand what matters to you and offer access to our heritage of creativity, bespoke services, and diverse product range, all supported by expert design solutions. Whether your vision calls for subtle elegance or bold statements, we provide tailored solutions to make your ideas shine.

Sustainability has always been a core concern, from eco-conscious materials and circular innovation to energy-efficient production we continually seek ways to improve our eco credentials. You can rest assured, our partnerships are built on integrity, respect, and care for the environment.

At Swarovski, we believe in individuality showcased through personalized customer service. More than just exceptional crystals, we offer a partnership defined by heritage, excellence, precision, innovation, and a commitment to you.

Why Swarovski

EXCELLENCE, THROUGH INNOVATION AND ORIGIN



X-CUT

Advanced optical measurement and high-precision manufacturing deliver premium cuts characterized by unmatched brilliance.



PLATINUM* PRO

With its new advanced foiling technique, Swarovski has set a new standard in the lifespan of crystals.



HOTFIX GLUE

The variable temperatures at which Hotfix glue can be activated enable the application of crystals on a broad range of textiles.



CRYSTALS - MADE IN AUSTRIA

The combination of innovation with sustainability and respect for individual wellbeing means that quality is always assured.

PREMIUM, BY SERVICE AND DESIGN



DESIGN SERVICE

Throughout its global network of Design Centers, Swarovski offers exceptional service provided by the industry's best creative talent.



APPLICATION SERVICE

A comprehensive range of application services means customers benefit from the extensive experience of leading international experts, as well as internal specialists.



GLOBAL SERVICE

Swarovski's Global Service Network provides customers with dedicated personal assistance on a local level.



CUSTOMIZED SERVICE

Choose new variations by going beyond Swarovski's tremendous standard assortment of Swarovski components and forward-integrated elements.

COMPLIANCE, WITH INTEGRITY



ADVANCED CRYSTAL

Swarovski's patented lead-free** formula has changed the DNA of crystals while still offering the same sparkle, dependability, and variety for which the brand is famous.



OEKO-TEX

Oeko-Tex® Standard 100 Class II (direct contact with skin) certification creates confidence in the chemical safety of textile applications.



CLEAR

Regular legal monitoring of chemical requirements and reasonable testing provide customers with the comfort of trust in Swarovski's products.



COMPLIANCE SERVICE

Assessments regarding substance limitations, as well as compliance information and advice to support customers in complying with relevant laws, regulations, and voluntary standards.

* Silver mirror coated with a platinum-colored protective layer.

** Crystal glass and all other materials containing 0.009% lead or less.

Basic Information

Key Facts

COLLECTION

As the global leader in precision-cut crystals, Swarovski is an active player in the worlds of jewelry, fashion, entertainment, design, and interiors. From small to large, Swarovski crystals have become an indispensable material for designers around the world, sparking inspiration, experimentation and play.

A dedication to precision and innovation has been a cornerstone of the company since its founding in 1895. This pursuit of excellence includes Swarovski's commitment

to quality and mastery of crystal-cutting but also to trend research which results in masterful modern cuts, colors, and effects—all highlighted seasonally in our comprehensive launch packages. Swarovski also offers segment-specific collections and customized product solutions, as well as personalized market insights.

For creative inspiration and further details on products and services, please contact your local Swarovski sales office.

ORDERING

Please contact your nearest Swarovski sales office to order products. Registered customers also have the convenient option to order online via the e-commerce service at swarovski.com/s-professionals. In addition to providing an

online ordering facility, the website also includes valuable product information, availability, delivery details and much more. Contact your Swarovski sales office to register for this service.

APPLICATION INFORMATION

Thanks to their outstanding quality and with the help of specially developed application techniques, Swarovski products can be processed easily and quickly to produce high-quality results.

The Application Manual provides in-depth information regarding all current application techniques and the technical services provided by Swarovski. It contains detailed illustrations and instructions for correct soldering, plating, gluing, sewing, embroidery, Hotfix, and mechanical application, as well as useful care instructions

and information about the required machines, tools, and aids and their suppliers. The manual is available in various international languages.

All detailed information regarding the Application Manual is also available as a free download on our business website swarovski.com/s-professionals. The application techniques are demonstrated in animations and videos. For specific questions regarding the application techniques, please contact your local Swarovski sales office.

UNCUT AND RIMMED ARTICLES

Uncut articles: /4

The crystals have not been cut and have no facets (e.g. art. 2080/4).

Rimmed articles: /I

Only a part of the article is treated with an effect (e.g. art. 2078/I).

SIZES

Various measurement abbreviations are used to classify the jewelry stones.



PP, SS

Pearl Plate (PP), Sieve Size or Stone Size (SS) for round crystals. Please also refer to the conversion table located at the back of the collection ("Open to See Sizes").

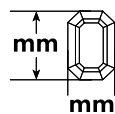

mm

Metric measurement in millimeters.

COLORS & EFFECTS

The assortment offers a wide range of colors, including all the classical jewelry colors. Creative grouping of the available colors can achieve combinations that are not only original but also rich in nuances.

Colors & Effects Categories

In the product matrices, colors and effects follow a specific segmentation:

Please note:

Colors and effects can appear different when illuminated with different light sources. Swarovski uses standard light source D50 for color decision and comparison. Special color cards for several product groups are located at the beginning of the relevant chapters.

Crystal	Crystal (001), foiled or unfoiled
Colors	
Plain Colors	Available plain colors
Opal Colors	Available opal colors
Swarovski ReCreated™ Colors	Available Swarovski ReCreated™ colors
TCF™ Colors	Available TCF™ colors
Colors	
Colors	Available plain colors
Gemcolors	Available Gemcolors
Iridescent Colors	Available Iridescent Colors
Crystal Effects or Color Effects	
Transparent Effects	Available transparent effects
Metallic Effects	Available metallic-appearance effects
Crystal Lacquer^{PRO} Effects	
Crystal Lacquer^{PRO} Ignite Effects	Available Crystal Lacquer ^{PRO} Ignite effects
Crystal Electric Lacquer^{PRO} Ignite Effects	Available Crystal Electric Lacquer ^{PRO} Ignite effects

For Crystals

For Crystal Pearls

EFFECTS

Vacuum Coating Effects

Vacuum coating processes on the outside of crystals produce either a special **surface** or a **translucent** effect, according to the application methods used.

Please find below a list of all Swarovski effects followed by an explanation of the special vacuum coating processes.

Surface Effects

(Vacuum coating on the front side of the crystal)



EFFECT CODE	NAME
AB	Aurore Boreale
ANTP	Antique Pink
AUR	Aurum
BLSH	Blue Shade

CAL	Comet Argent Light
GSHA	Golden Shadow
HEM	Hematite (only on Jet)
LTCH	Light Chrome
MLGLD	Metallic Light Gold
METSH	Metallic Sunshine
MOL	Moonlight
NIFA	Nightfall
PARSH	Paradise Shine
ROGL	Rose Gold
SHIM	Shimmer
SSHA	Silver Shade
TRA	Transmission

EFFECTS CONT.

Translucent Effects

(Vacuum coating on the reverse side of the crystals, effect shines through the transparent crystal)



EFFECT CODE	NAME
BBL	Bermuda Blue
HEL	Heliotrope
IGNIT	Ignite
SINI	Silver Night
VL	Vitrail Light
VM	Vitrail Medium
VOL	Volcano

Crystal Lacquer^{PRO} Effects

A premium opaque varnish that is applied to the reverse side of the crystals instead of foiling, resulting in an opalescent appearance.

Crystal Lacquer^{PRO} Ignite Effects

EFFECT CODE	NAME
001 L165I	Crystal Agave Ignite
001 L177I	Crystal Dahlia Ignite
001 L111I	Crystal Dark Grey Ignite
001 L166I	Crystal Denim Ignite
001 L162I	Crystal Flamingo Ignite
001 L164I	Crystal Linen Ignite
001 L152I	Crystal Mango Ignite
001 L160I	Crystal Maroon Ignite
001 L159I	Crystal Orange Ignite
001 L171I	Crystal Orchid Ignite
001 L170I	Crystal Pine Green Ignite
001 L179I	Crystal Poppy Red Ignite
001 L161I	Crystal Purple Ignite
001 L163I	Crystal Sky Ignite
001 L168I	Crystal Soft Mint Ignite
001 L167I	Crystal Soft Rose Ignite
001 L169I	Crystal Soft Yellow Ignite
001 L178I	Crystal Teal Ignite

Crystal Electric Lacquer^{PRO} Ignite Effects

Neon-inspired lacquer colors with Ignite Effect that glow under UV-Light

EFFECT CODE	NAME
001 L134I	Crystal Electric Blue Ignite
001 L135I	Crystal Electric Green Ignite
001 L136I	Crystal Electric Orange Ignite
001 L137I	Crystal Electric Pink Ignite
001 L148I	Crystal Electric Violet Ignite
001 L139I	Crystal Electric White Ignite
001 L138I	Crystal Electric Yellow Ignite

Variations on Surface Effects



2x
Both sides of the crystals are treated with an effect (e.g. art. 5328 AB 2x).



B
Effects on three sides of a cube shape (e.g. art. 5601 AB B).



V
The effect is used in reverse. A surface effect is used like a translucent effect (e.g. art. 2303 NoHF GSHA V - Golden Shadow on reverse side).



Z
Only a part of the crystals is treated with an effect (e.g. art. 4869 CAVZ (Comet Argent Light V Z)).





CAL'V'SI & CAL'VZ'SI

The effect CAL (Comet Argent Light) effect is also used as a mirror coating on the reverse side of the crystals instead of standard foilings (A, F, etc.) in special cases.











/G

Article with a partly (PF) or fully frosted (FF) surface.







Colors

	Crystal 001
	White Opal 234
	Light Silk 261
	Silk 391
	Light Peach 362
	Rosaline 508
	Rose Water Opal 395
	Vintage Rose 319
	Blush Rose 257
	Light Rose 223
	Rose Peach 262
	Padparadscha 542
	Indian Pink 289
	Rose 209
	Fuchsia 502
	Light Siam 227
	Scarlet 276
	Indian Siam 327
	Siam 208
	Ruby 501
	Burgundy 515
	Amethyst 204
	Iris 219



	Light Amethyst 212
	Violet 371
	Provence Lavender 283
	Tanzanite 539
	Purple Velvet 277
	Light Azure 361
	Aquamarine 202
	Light Sapphire 211
	Sapphire 206
	Capri Blue 243
	Majestic Blue 296
	Cobalt 369
	Dark Indigo 288
	Montana 207
	Denim Blue 266
	Indicolite 379
	Light Turquoise 263
	Blue Zircon 229
	Erinite 360
	Chrysolite 238
	Citrus Green 337
	Fern Green 291
	Majestic Green 336

	Emerald 205
	Jonquil 213
	Light Topaz 226
	Sunflower 292
	Light Colorado Topaz 246
	Topaz 203
	Greige 284
	Black Diamond 215
	Graphite 253
	Jet 280























Swarovski ReCreated™ Colors

	ReCreated™ Ice Blue 1405
	ReCreated™ Dark Sapphire 1404
	ReCreated™ Peridot 1408
	ReCreated™ Dark Jonquil 1407
	ReCreated™ Light Smoked Topaz 1402
	ReCreated™ Smoked Topaz 1403

TCF™ Colors

	Dark Rose 1201 TCF™
	Dark Orange 1202 TCF™

Effects

-  Crystal Moonlight
001 MOL
-  Crystal Transmission
Hotfix Transparent
001 TRA HFT
-  Crystal Shimmer
001 SHIM
-  Crystal Aurore Boreale
001 AB
-  Crystal Antique Pink
001 ANTP
-  Crystal Vitrail Light
001 VL
-  Crystal Paradise Shine
001 PARSH
-  Crystal Vitrail Medium
001 VM
-  Crystal Volcano
001 VOL
-  Crystal Heliotrope
001 HEL
-  Crystal Bermuda Blue
001 BBL
-  Crystal Blue Shade
001 BLSH
-  Crystal Golden Shadow
001 GSHA
-  Crystal Metallic Sunshine
001 METSH
-  Crystal Aurum
001 AUR
-  Crystal Rose Gold
001 ROGL
-  Crystal Metallic Light Gold
001 MLGLD
-  Crystal Light Chrome
001 LTCH
-  Crystal Comet Argent Light
001 CAL
-  Crystal Silver Shade
001 SSHA
-  Crystal Silver Night
001 SINI
-  Jet Hematite
280 HEM

Crystal Lacquer^{PRO} Effects



















Crystal Lacquer^{PRO} Ignite Effects

-  Crystal Linen Ignite
001 L164I
-  Crystal Soft Rose Ignite
001 L167I
-  Crystal Flamingo Ignite
001 L162I
-  Crystal Dahlia Ignite
001 L171I
-  Crystal Orange Ignite
001 L159I
-  Crystal Maroon Ignite
001 L160I
-  Crystal Poppy Red Ignite
001 L179I
-  Crystal Orchid Ignite
001 L171I
-  Crystal Purple Ignite
001 L161I
-  Crystal Sky Ignite
001 L163I
-  Crystal Denim Ignite
001 L166I
-  Crystal Teal Ignite
001 L178I
-  Crystal Pine Green Ignite
001 L170I
-  Crystal Agave Ignite
001 L165I
-  Crystal Soft Mint Ignite
001 L168I
-  Crystal Mango Ignite
001 L152I
-  Crystal Soft Yellow Ignite
001 L169I
-  Crystal Dark Grey Ignite
001 L111I





Crystal Electric Lacquer^{PRO} Ignite Effects

-  Crystal Electric White Ignite
001 L139I
-  Crystal Electric Orange Ignite
001 L136I
-  Crystal Electric Pink Ignite
001 L137I
-  Crystal Electric Violet Ignite
001 L148I
-  Crystal Electric Blue Ignite
001 L134I
-  Crystal Electric Green Ignite
001 L135I
-  Crystal Electric Yellow Ignite
001 L138I









Shimmer Effects

-  White Opal Shimmer
234 SHIM
-  Silk Shimmer
391 SHIM
-  Rose Water Opal Shimmer
395 SHIM
-  Light Rose Shimmer
223 SHIM
-  Rose Shimmer
209 SHIM
-  Fuchsia Shimmer
502 SHIM
-  Light Siam Shimmer
227 SHIM
-  Scarlet Shimmer
276 SHIM
-  Siam Shimmer
208 SHIM
-  Amethyst Shimmer
204 SHIM
-  Light Amethyst Shimmer
212 SHIM
-  Tanzanite Shimmer
539 SHIM
-  Aquamarine Shimmer
202 SHIM
-  Light Sapphire Shimmer
211 SHIM
-  Blue Zircon Shimmer
229 SHIM
-  Erinite Shimmer
360 SHIM
-  ReCreated™ Peridot Shimmer
1408 SHIM
-  Emerald Shimmer
205 SHIM
-  Light Topaz Shimmer
226 SHIM
-  Light Colorado Topaz Shimmer
246 SHIM
-  Topaz Shimmer
203 SHIM
-  Black Diamond Shimmer
215 SHIM
-  Jet Shimmer
280 SHIM

AB Effects

-  Light Rose Aurore Boreale
223 AB
-  Light Siam Aurore Boreale
227 AB
-  Sapphire Aurore Boreale
206 AB
-  Jonquil Aurore Boreale
213 AB
-  Jet Aurore Boreale
280 AB

Ignite Effects

-  Crystal Ignite
001 IGNIT
-  Vintage Rose Ignite
319 IGNIT
-  Light Rose Ignite
223 IGNIT
-  Rose Peach Ignite
262 IGNIT
-  Scarlet Ignite
276 IGNIT
-  Amethyst Ignite
204 IGNIT
-  Aquamarine Ignite
202 IGNIT
-  Emerald Ignite
205 IGNIT
-  Light Colorado Topaz Ignite
246 IGNIT

Nightfall Effects

-  Siam Nightfall
208 NIFA
-  Capri Blue Nightfall
243 NIFA
-  Emerald Nightfall
205 NIFA
-  Graphite Nightfall
253 NIFA

Cabochons

-  Crystal White Pearl
001 650
-  Crystal Nacre
001 191
-  Crystal Creampearl
001 291
-  Crystal Golden Shadow
001 GSHA
-  Crystal Rosaline Pearl
001 294
-  Crystal Dark Grey Pearl
001 617
-  Jet
280
-  Jet Hematite
280 HEM

Crystal Lacquer^{PRO} Ignite Effects

-  Crystal Linen Ignite
001 L164I
-  Crystal Flamingo Ignite
001 L162I
-  Crystal Agave Ignite
001 L165I
-  Crystal Soft Mint Ignite
001 L168I

Crystal Electric Lacquer^{PRO} Ignite Effects

-  Crystal Electric White Ignite
001 L139I
-  Crystal Electric Orange Ignite
001 L136I
-  Crystal Electric Pink Ignite
001 L137I
-  Crystal Electric Violet Ignite
001 L148I
-  Crystal Electric Blue Ignite
001 L134I
-  Crystal Electric Green Ignite
001 L135I
-  Crystal Electric Yellow Ignite
001 L138I

Rimmed Flat Backs

-  Jet Light Chrome Z
280 LTCHZ

FOILING

Foiling is the process of mirror coating the reverse side of the crystals.



Silver Foiling (A)

A silver mirror finish for XIRIUS and XILION Hotfix articles only.



Platinum* PRO Foiling (F)

A silver mirror finish that is coated with a platinum-colored protective layer of the highest quality (e.g. art. 4120).



Aluminum Foiling (M)

An aluminum mirror finish is applied using a vacuum coating process (e.g. art. 2303 Flat Back HF).



Protective Layer (P) for Beads and Pendants

Protective layer is a transparent lacquer system that is applied over the effects. This lacquer is designed to protect the effects from scratches, fingerprints, and other damage, and also helps to prevent moisture that can lead to corrosion (e.g. perspiration) penetrating into the effect layer when jewelry is designed to incorporate Crystal Stones that are not set in casings/settings.



Unfoiled (U)

HOTFIX TECHNOLOGY

Hotfix (HF)

Hotfix technology involves applying specially developed glue onto the reverse side of Flat Backs. The glue is extremely flexible and is activated at a temperature of 120°C, with the option of being applied up to 170°C. It bonds with the carrier material and the crystals become permanently fixed during cooling.

Hotfix Transparent (HFT)

This variant of the Hotfix technology is a patented bonding agent that is applied to the reverse side of

non-mirror-finished Flat Backs, resulting in an interesting "raindrop" effect in which the crystals take on the color of the carrier material.

This transparent bonding agent is also used with Crystal Lacquer^{PRO} effects on Flat Backs.

No Hotfix (No HF)

Flat Back articles are also available as No Hotfix articles with no glue on the reverse side. For more information please contact your local Swarovski sales office.

DISCLAIMER

The material manufactured by Swarovski is considered as "crystal glass", category 3, in accordance with European Council Directive 69/493 on the approximation of the laws of the Member States relating to crystal glass. Whenever referring to "crystal" in this document, Swarovski either refers to a singular component or product made of crystal glass, or the material crystal glass.

* Silver mirror coated with a platinum-colored protective layer.

LAWS, REGULATIONS, NORMS, AND STANDARDS

The composition of loose and forward-integrated crystals in the Advanced Crystal standard is compliant with regulatory industry norms and laws regarding the restriction or prohibition of certain substances for finished

products in the most relevant segments of our customers' businesses. Further information can be found at swarovski.com/s-professionals.

WARNING NOTICES

General Warning

Loose crystals may present a small parts hazard to young children, particularly children under three years old. Depending on the size of the crystal and any attached material (such as glue, fabric, etc.), children may choke on, inhale, swallow, or insert the crystal into their noses. Magnetic products with crystal applications pose a particular risk of serious intestinal injury if ingested. The application techniques as stated in the Application Manual do not guarantee that crystals will not come loose or chip. For each application, the manufacturer must determine whether the product meets the relevant requirements related to small parts hazards and assess any risk it may pose, in particular to small children. Failure to follow Swarovski's care instructions may result in damage to the crystals, which could pose a risk of laceration or other harm.

Warning for Tableware

The application of loose crystals to tableware presents a potential risk of aspiration, choking, swallowing, or tooth damage should crystals become loose. To reduce this risk, crystals should never be applied to any surface of tableware likely to come in contact with food or the mouth, and crystals should never be placed on any tableware intended for use by children. Tableware with crystals intended for decorative use only should be marked as such. To avoid dishwasher damage, tableware decorated with crystals should be washed by hand. The application techniques or suggestions in this manual do not guarantee that crystals will not come loose. For each application, the manufacturer must determine whether the product meets relevant requirements related to small parts hazards or use in food contact items and assess any risk it may pose to users. The use of crystals (which may contain restricted substances deemed hazardous under local laws) and adhesives on tableware is subject to legal restrictions in specific countries. The customer is fully responsible for complying with these country-specific provisions and shall defend, indemnify, and hold Swarovski harmless from any and all third-party claims based on product liability or otherwise relating to uses of Swarovski products, and waives all its own claims against Swarovski.

Unsuitable Applications

Crystals from Swarovski are intended for use in the fields of fashion, jewelry, accessories, textile products, and for interior décor. Due to their physical properties, crystals from Swarovski are unsuitable for other uses (e.g. gluing onto teeth, using on or near mucous membranes, and other unsafe uses). The customer shall defend, indemnify, and hold Swarovski harmless from any and all third-party claims based on product liability or otherwise relating to uses of Swarovski products purchased by the customer, and waives all its own claims.

Responsibility of User

Failure to follow Swarovski's care instructions may result in damage to the crystals, which could pose a risk of laceration or other harm.

Any verbal, written, or test-based advice that Swarovski provides regarding techniques for the application of its products is a recommendation based on Swarovski's current knowledge and the information provided by its suppliers. Such advice does not discharge the customer from carrying out its own tests of techniques it proposes to use and their suitability for the intended application. The application, use, and processing of these techniques and products are solely the user's responsibility.

Change of Product





Swarovski reserves the right to modify the dimensions, shape, composition and concentration of components belonging to products that are referred to in this Product Information brochure. Furthermore, any applicable laws and regulations mentioned are subject to change, which is why Swarovski regularly publishes an updated version of the Product Information brochure containing facts, (application) instructions, and the current legal situation that is valid at the time of publication. References to compliance with such regulations as are stated above are based on their requirements as of the current date. Anyone seeking an in-depth understanding of the provisions should read the various laws in their entirety and/or seek advice from a legal counsel.

The customer must request and observe the valid version of the Product Information brochure before (re)ordering and using the products.

Care Instructions

To ensure the highest quality and long-lasting applications of Swarovski products, proper care is essential.

Textile Care Instructions

						
GENERAL RECOMMENDATIONS		Turn inside out, choose a gentle wash cycle and use mild laundry detergent.			Turn inside out and use mild laundry detergent.**	Do not wash!
		To protect the crystals as much as possible, the use of a soft wash bag is recommended.				
Round Stones		✓				
Flat Backs No Hotfix¹		✓				
Flat Backs Hotfix	XILION Rose, XIRIUS Rose ¹ , Framed Flat Backs & Creation Stones	✓				
	Creation Stones Plus ²				✓	
	Cabochons		✓			
Sew-on Articles & Crystal Buttons	Sew-on Articles	✓***			✓	
	Crystal Buttons	✓				
Fancy Stones		✓				
Beads		✓				
Crystal Pearls		✓		✓	✓	
Pendants						✓
Crystal Transfers	XILION Transfers, XIRIUS Transfers ¹ , Framed Flat Back Transfers, Creation Transfers	✓				
	Creation Transfers Plus ²				✓	
	Mezzo Transfers		✓			
	Cabochon Transfers		✓			
Crystal Textures Hotfix	Crystal Fabric		✓			
	Crystal Intarsia				✓	
	Crystal Rocks Family		✓			
	Crystaltex Chaton Bandings		✓			
	Graphic Feature			✓****	✓	
Crystal Textures IT & Removable Foil	All Crystal Textures IT and Removable Foil					✓
Crystal Textures Coldfix	All Crystal Textures Coldfix				✓	
Linked Crystal Components	Crystal Mesh Standard & Crystal Fine Mesh				✓	
	Cupchains					✓
Crystal Rivets & Rose Pins	Crystal Rivets		✓			
	Rose Pins		✓			

* Colors are machine washable at 60°C (140°F). Please take note of the general care instructions in the Application Manual dependent on the product groups where the colors are applied. Swarovski effects are only washable with 40°C (104°F) maximum.

** Wash by hand: max. temperature 30°C (86°F), very mild process.

1 XIRIUS size SS 40 and SS 48; only wash on a hand wash program.

2 Creation Stones Plus have a stone size starting at 8 mm and/or a height starting at 4 mm.

*** Sew-on Articles 28 mm and above: Wash by hand

**** Please check the appropriate Product Information for Graphic as the washing parameters are different between Graphic Foil print and Graphic Glass print.

Textile Care Instructions

						
		Do not use chlorine bleach!	Turn inside out and dry at reduced temperature.	Do not tumble dry!	Iron inside out using a silk/polyester/viscose setting. Ironing the textile inside out and using a pressing cloth is recommended.	Iron inside out using a wool setting.
Round Stones		✓		✓		
Flat Backs No Hotfix¹		✓		✓		
Flat Backs Hotfix	XILION Rose, XIRIUS Rose ¹ , Framed Flat Backs & Creation Stones	✓	✓		✓	
	Creation Stones Plus ²	✓		✓		
	Cabochons	✓	✓		✓	
Sew-on Articles & Crystal Buttons	Sew-on Articles	✓		✓		
	Crystal Buttons	✓		✓		
Fancy Stones		✓		✓		
Beads		✓	✓			
Crystal Pearls		✓		✓		
Pendants		✓		✓		
Crystal Transfers	XILION Transfers, XIRIUS Transfers ¹ , Framed Flat Back Transfers, Creation Transfers	✓	✓		✓	
	Creation Transfers Plus ²	✓		✓		
	Mezzo Transfers	✓		✓	✓	
	Cabochon Transfers	✓	✓		✓	
Crystal Textures Hotfix	Crystal Fabric	✓		✓	✓	
	Crystal Intarsia	✓		✓	✓	
	Crystal Rocks Family	✓		✓	✓	
	Crystaltex Chaton Bandings	✓		✓	✓	
	Graphic Feature	✓		✓	✓	
Crystal Textures IT & Removable Foil	All Crystal Textures IT and Removable Foil					
Crystal Textures Coldfix	All Crystal Textures Coldfix	✓		✓		
Linked Crystal Components	Crystal Mesh Standard & Crystal Fine Mesh	✓		✓		
	Cupchains	✓		✓		
Crystal Rivets & Rose Pins	Crystal Rivets	✓		✓		
	Rose Pins	✓		✓		

¹ XIRIUS size SS 40 and SS 48: only wash on a hand wash program.

² Creation Stones Plus have a stone size starting at 8 mm and/or a height starting at 4 mm.

						
		Do not iron!	The textile can be gently dry-cleaned using perchlorethylene. Turn inside out.	The textile can be gently dry-cleaned using hydrocarbon. Turn inside out.	The textile will withstand gentle professional wet cleaning. Turn inside out.	The textile may not be dry-cleaned.
		To protect the crystals as much as possible, the use of a soft wash bag is recommended.				
Round Stones		✓		✓	✓	
Flat Backs No Hotfix¹		✓		✓	✓	
Flat Backs Hotfix	XILION Rose, XIRIUS Rose ¹ , Framed Flat Backs & Creation Stones		✓	✓	✓	
	Creation Stones Plus ²	✓	✓	✓	✓	
	Cabochons		✓	✓	✓	
Sew-on Articles & Crystal Buttons	Sew-on Articles	✓	✓	✓	✓	
	Crystal Buttons	✓	✓	✓	✓	
Fancy Stones		✓		✓	✓	
Beads		✓	✓	✓	✓	
Crystal Pearls		✓	✓	✓	✓	
Pendants		✓				✓
Crystal Transfers	XILION Transfers, XIRIUS Transfers ¹ , Framed Flat Back Transfers, Creation Transfers		✓	✓	✓	
	Creation Transfers Plus ²	✓	✓	✓	✓	
	Mezzo Transfers			✓	✓	
	Cabochon Transfers		✓	✓	✓	
Crystal Textures Hotfix	Crystal Fabric				✓	
	Crystal Intarsia				✓	
	Crystal Rocks Family				✓	
	Crystaltex Chaton Bandings				✓	
	Graphic Feature				✓	
Crystal Textures IT & Removable Foil	All Crystal Textures IT and Removable Foil					
Crystal Textures Coldfix	All Crystal Textures Coldfix	✓			✓	
Linked Crystal Components	Crystal Mesh Standard & Crystal Fine Mesh	✓		✓	✓	
	Cupchains	✓				✓
Crystal Rivets & Rose Pins	Crystal Rivets	✓	✓	✓	✓	
	Rose Pins	✓	✓	✓	✓	

1 XIRIUS size SS 40 and SS 48: only wash on a hand wash program.
 2 Creation Stones Plus have a stone size starting at 8 mm and/or a height starting at 4 mm.

General Care Instructions

A light layer of dust is most easily removed with a clean, dry, antistatic cloth. It is best to also wear white cotton gloves so as to avoid unsightly fingerprints. For heavier dirt, lukewarm water with a little dishwashing detergent will suffice. Ideally you should use a clean microfiber or thin, lint-free cotton cloth that has been wrung out as much as possible.



Cloth

Not following Swarovski care instructions can damage the product and thus lead to damage of textiles or other damage.

Please note that with all standard washing processes (whether carried out by a household washing machine or via dry cleaning) the rotation of the drum places significant mechanical forces on the textiles. The most important factor in ensuring a secure wash is correctly applying the product, without compromising its adhesion. The larger the product employed, and the more products are applied next to each other, the greater the risk of damage. Swarovski products are made out of crystal or contain crystal and must thus be handled with suitable care.

In general it is recommended that a soft wash bag is used and that the washer drum is filled to protect against damage.

To maintain the quality of crystals from Swarovski, the following is also important:

Before washing, turn items of clothing inside out, select a gentle wash cycle, and use a mild detergent.

Gently wipe each individual crystal and dry with a clean cloth. It is best to wear white cotton gloves here as well.

Please ensure that when cleaning with moisture, only cleaning agents that do not damage the surrounding material are used. By correctly cleaning your Swarovski crystals, you will restore the full reflectivity.

According to DIN EN ISO 3758, our care instructions list all product groups, meaning each product used by customers must be assessed separately with regard to its washability and suitability for its purpose/the end product. The recommendations given by Swarovski reflect our current level of knowledge. Swarovski uses these recommendations to decide on the suitability of the product for textile applications.

Customers are solely responsible for defining the recommended cleaning processes for the end product, and must consider the care advice of Swarovski and any other manufacturers in doing so.

The type of shape, cut, surface effect, and size, as well as the weight of the application and the quantity of crystals used has a significant impact on the cleaning process to be followed.

To avoid all risks, customers/textile cleaning companies should remove any large crystals (elements, buttons, etc...), that have been stitched on before cleaning, and stitch them back on again afterwards.



Components Collection

ROUND STONES	01
FLAT BACKS NO HOTFIX	02
FLAT BACKS HOTFIX	03
SEW-ON ARTICLES & CRYSTAL BUTTONS	04
FANCY STONES	05
BEADS	06
CRYSTAL PEARLS	07
PENDANTS	08
CRYSTAL TRANSFERS	09
CRYSTAL TEXTURES	10
LINKED CRYSTAL COMPONENTS	11
CRYSTAL RIVETS & ROSE PINS	12
APPLICATION TOOLS	13



Round Stones

Our Round Stones are testament to timeless elegance and exceptional craftsmanship. These versatile, loose elements – some featuring a pointed reverse side – are designed for ease of placement in pre-set cavities or metal claws, allowing you to bring your most creative visions to life.





















Available in an array of precision cuts and an extensive range of sizes, the collection includes the XERO Chaton, the smallest size ever crafted, and the XIRIUS Chaton, renowned for its unparalleled brilliance. Each stone reflects our rich heritage, cultural refinement, and our unwavering passion for creativity.









Forged with savoir-faire and knowledge passed down through generations, our Round Stones honor tradition while pushing the boundaries of innovation. Unlocking limitless possibility for our partners, they uphold our unwavering commitment to quality, artistry, and radiant brilliance.

Colors & Effects







Colors & Effects

Colors

-  Crystal 001
-  White Opal 234
-  Silk 391
-  Vintage Rose 319
-  Light Rose 223
-  Rose Peach 262
-  Rose 209
-  Light Siam 227
-  Scarlet 276
-  Siam 208
-  Amethyst 204
-  Iris 219
-  Light Amethyst 212
-  Violet 371
-  Tanzanite 539
-  Aquamarine 202
-  Light Sapphire 211
-  Sapphire 206
-  Montana 207
-  Denim Blue 266
-  Light Turquoise 263

-  Chrysolite 238
-  Citrus Green 337
-  Majestic Green 336
-  Emerald 205
-  Light Topaz 226
-  Light Colorado Topaz 246
-  Greige 284
-  Black Diamond 215
-  Jet 280

Swarovski ReCreated™ Colors

-  ReCreated™ Ice Blue 1405
-  ReCreated™ Dark Sapphire 1404
-  ReCreated™ Peridot 1408
-  ReCreated™ Dark Jonquil 1407
-  ReCreated™ Light Smoked Topaz 1402
-  ReCreated™ Smoked Topaz 1403

TCF™ Colors

-  Dark Rose 1201 TCF™
-  Dark Orange 1202 TCF™

Effects

-  Crystal Moonlight 001 MOL
-  Crystal Aurore Boreale 001 AB
-  Crystal Golden Shadow 001 GSHA
-  Crystal Aurum 001 AUR
-  Crystal Silver Shade 001 SSHA
-  Crystal Silver Night 001 SINI
-  Jet Hematite 280 HEM









Crystal Lacquer^{PRO} Effects

Crystal Lacquer^{PRO} Ignite Effects

-  Crystal Linen Ignite 001 L164I
-  Crystal Soft Rose Ignite 001 L167I
-  Crystal Flamingo Ignite 001 L162I
-  Crystal Dahlia Ignite 001 L177I
-  Crystal Orange Ignite 001 L159I
-  Crystal Maroon Ignite 001 L160I
-  Crystal Poppy Red Ignite 001 L179I
-  Crystal Orchid Ignite 001 L171I
-  Crystal Purple Ignite 001 L161I

Ignite Effects

-  Crystal Sky Ignite
001 L163I
-  Crystal Denim Ignite
001 L166I
-  Crystal Teal Ignite
001 L178I
-  Crystal Pine Green Ignite
001 L170I
-  Crystal Agave Ignite
001 L165I
-  Crystal Soft Mint Ignite
001 L168I
-  Crystal Soft Yellow Ignite
001 L169I
-  Crystal Mango Ignite
001 L152I
-  Crystal Dark Grey Ignite
001 L111I

-  Crystal Ignite
001 IGNIT
-  Vintage Rose Ignite*
319 IGNIT
-  Light Rose Ignite
223 IGNIT
-  Rose Peach Ignite*
262 IGNIT
-  Scarlet Ignite
276 IGNIT
-  Amethyst Ignite
204 IGNIT
-  Aquamarine Ignite
202 IGNIT
-  Emerald Ignite
205 IGNIT
-  Light Colorado Topaz Ignite
246 IGNIT

Crystal Electric Lacquer^{PRO} Ignite Effects

-  Crystal Electric White Ignite
001 L139I
-  Crystal Electric Orange Ignite
001 L136I
-  Crystal Electric Pink Ignite
001 L137I
-  Crystal Electric Violet Ignite
001 L148I
-  Crystal Electric Blue Ignite
001 L134I
-  Crystal Electric Green Ignite
001 L135I
-  Crystal Electric Yellow Ignite
001 L138I

*this color does not exist for 1088, but for other Round Stones. For more details, please see the product matrix on the respective items.

Numerical Order

001	Crystal	001 L1771	Crystal Dahlia Ignite	246	Light Colorado Topaz
001 AB	Crystal Aurore Boreale	001 L1781	Crystal Teal Ignite	262	Rose Peach
001 AUR	Crystal Aurum	001 L1791	Crystal Poppy Red Ignite	262 IGNIT	Rose Peach Ignite
001 GSHA	Crystal Golden Shadow	001 MOL	Crystal Moonlight	263	Light Turquoise
001 IGNIT	Crystal Ignite	001 SINI	Crystal Silver Night	266	Denim Blue
001 L1111	Crystal Dark Grey Ignite	001 SSHA	Crystal Silver Shade	276 IGNIT	Scarlet Ignite
001 L1341	Crystal Electric Blue Ignite	202 IGNIT	Aquamarine Ignite	276	Scarlet
001 L1351	Crystal Electric Green Ignite	202	Aquamarine	280 HEM	Jet Hematite
001 L1361	Crystal Electric Orange Ignite	204 IGNIT	Amethyst Ignite	280	Jet
001 L1371	Crystal Electric Pink Ignite	204	Amethyst	284	Greige
001 L1381	Crystal Electric Yellow Ignite	205 IGNIT	Emerald Ignite	319	Vintage Rose
001 L1391	Crystal Electric White Ignite	205	Emerald	319 IGNIT	Vintage Rose Ignite
001 L1481	Crystal Electric Violet Ignite	206	Sapphire	336	Majestic Green
001 L1521	Crystal Mango Ignite	207	Montana	337	Citrus Green
001 L1591	Crystal Orange Ignite	208	Siam	371	Violet
001 L1601	Crystal Maroon Ignite	209	Rose	391	Silk
001 L1611	Crystal Purple Ignite	211	Light Sapphire	539	Tanzanite
001 L1621	Crystal Flamingo Ignite	212	Light Amethyst	1201 TCF™	Dark Rose
001 L1631	Crystal Sky Ignite	215	Black Diamond	1202 TCF™	Dark Orange
001 L1641	Crystal Linen Ignite	219	Iris	1402	ReCreated™ Light Smoked Topaz
001 L1651	Crystal Agave Ignite	223 IGNIT	Light Rose Ignite	1403	ReCreated™ Smoked Topaz
001 L1661	Crystal Denim Ignite	223	Light Rose	1404	ReCreated™ Dark Sapphire
001 L1671	Crystal Soft Rose Ignite	226	Light Topaz	1405	ReCreated™ Ice Blue
001 L1681	Crystal Soft Mint Ignite	227	Light Siam	1407	ReCreated™ Dark Jonquil
001 L1691	Crystal Soft Yellow Ignite	234	White Opal	1408	ReCreated™ Peridot
001 L1701	Crystal Pine Green Ignite	238	Chrysolite		
001 L1711	Crystal Orchid Ignite	246 IGNIT	Light Colorado Topaz Ignite		

Alphabetical Order

Amethyst (204)	Crystal Moonlight (001 MOL)	Light Sapphire (211)
Amethyst Ignite (204 IGNIT)	Crystal Orange Ignite (001 L1591)	Light Siam (227)
Aquamarine (202)	Crystal Orchid Ignite (001 L1711)	Light Topaz (226)
Aquamarine Ignite (202 IGNIT)	Crystal Pine Green Ignite (001 L1701)	Light Turquoise (263)
Black Diamond (215)	Crystal Poppy Red Ignite (001 L1791)	Majestic Green (336)
Chrysolite (238)	Crystal Purple Ignite (001 L1611)	Montana (207)
Citrus Green (337)	Crystal Silver Night (001 SINI)	ReCreated™ Dark Jonquil (1407)
Crystal (001)	Crystal Silver Shade (001 SSHA)	ReCreated™ Dark Sapphire (1404)
Crystal Agave Ignite (001 L1651)	Crystal Sky Ignite (001 L1631)	ReCreated™ Ice Blue (1405)
Crystal Aurore Boreale (001 AB)	Crystal Soft Mint Ignite (001 L1681)	ReCreated™ Light Smoked Topaz (1402)
Crystal Aurum (001 AUR)	Crystal Soft Rose Ignite (001 L1671)	ReCreated™ Peridot (1408)
Crystal Dahlia Ignite (001 L1771)	Crystal Soft Yellow Ignite (001 L1691)	ReCreated™ Smoked Topaz (1403)
Crystal Dark Grey Ignite (001 L1111)	Crystal Teal Ignite (001 L1781)	Rose (209)
Crystal Denim Ignite (001 L1661)	Dark Orange (1202 TCF™)	Rose Peach (262)
Crystal Electric Blue Ignite (001 L1341)	Dark Rose (1201 TCF™)	Rose Peach Ignite (262 IGNIT)
Crystal Electric Green Ignite (001 L1351)	Denim Blue (266)	Sapphire (206)
Crystal Electric Orange Ignite (001 L1361)	Emerald (205)	Scarlet (276)
Crystal Electric Pink Ignite (001 L1371)	Emerald Ignite (205 IGNIT)	Scarlet Ignite (276 IGNIT)
Crystal Electric Violet Ignite (001 L1481)	Greige (284)	Siam (208)
Crystal Electric White Ignite (001 L1391)	Iris (219)	Silk (391)
Crystal Electric Yellow Ignite (001 L1381)	Jet (280)	Tanzanite (539)
Crystal Flamingo Ignite (001 L1621)	Jet Hematite (280 HEM)	Vintage Rose (319)
Crystal Golden Shadow (001 GSHA)	Light Amethyst (212)	Vintage Rose Ignite (319 IGNIT)
Crystal Ignite (001 IGNIT)	Light Colorado Topaz (246)	Violet (371)
Crystal Linen Ignite (001 L1641)	Light Colorado Topaz Ignite (246 IGNIT)	White Opal (234)
Crystal Maroon Ignite (001 L1601)	Light Rose (223)	
Crystal Mango Ignite (001 L1521)	Light Rose Ignite (223 IGNIT)	

For details on available colors and effects for each article within the product groups, please see the product matrix of the respective item in the Collection 2026.

The plating resistance of effects is tested according to Swarovski's plating guidelines (SWAROVSKI.COM/S-PROFESSIONALS). Customers are advised to carry out their own tests if their plating parameters diverge from Swarovski plating guidelines.



Colors and effects can appear different when illuminated with different light sources. Swarovski uses standard light source D65 for color decision and comparison. Slight changes in shades are unavoidable. Colors may vary according to cut and foiling.



The composition of Advanced Crystal is compliant with regulatory industry norms and laws regarding the restriction or prohibition of certain substances in the most relevant segments of our customers. Please note that the compliance of the colors Light Siam and Siam varies according to certain industry regulations. Those regulations are indicated with * in the compliance overview. Indian Siam, Ruby and Scarlet (option to Lt. Siam) conform to all CLEAR-lists. For further information please visit swarovski.com/s-professionals



© 2026 D. Swarovski Distribution GmbH



Summary



1 2 3



   **1028**
PP 2, 3, 4, 5, 6, 7, 8, 9, 10, 11, 12, 13

   **1088**
PP 14, 18, 21, 24, 27, 31, 32
SS 19, 24, 29, 34, 39

   **1098**
PP 24 (SS12), PP 31 (SS 16)
SS 20, 24, 29, 34, 39

   **1100**
PP 1

   **1122**
SS 39, 47
12, 14 mm

   **1383**
8, 10, 14 mm

   **1400**
10, 12, 14, 18 mm

   **1401**
8, 11.8 mm

01

1100 XERO Chaton

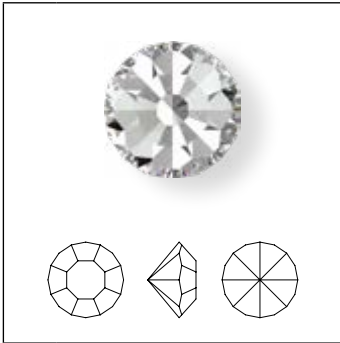

Size PP 1

1028 XILION Chaton

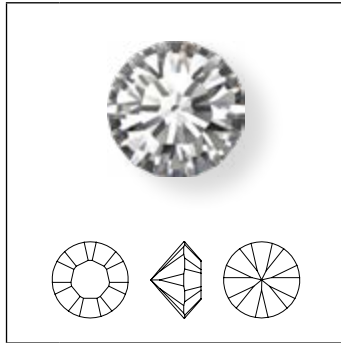

Size PP 2, 3, 4, 5, 6, 7, 8, 9, 10, 11, 12, 13

1088 XIRIUS Chaton



Size PP 14, 18, 21, 24, 27, 31, 32
SS 19, 24, 29, 34, 39

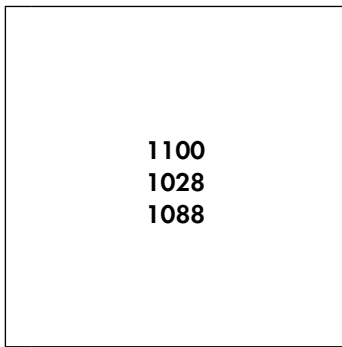

Size	PP 1	PP 2	PP 3	PP 4	PP 5	PP 6	PP 7	PP 8	PP 9	PP 10	PP 11	PP 12	PP 13	PP 14	PP 18	PP 21	PP 24	PP 27	PP 31	PP 32	SS 19	SS 24	SS 29	SS 34	SS 39
------	------	------	------	------	------	------	------	------	------	-------	-------	-------	-------	-------	-------	-------	-------	-------	-------	-------	-------	-------	-------	-------	-------

Crystal

Crystal F (001)

Colors

Plain Colors

- Amethyst F (204)
- Aquamarine F (202)
- Black Diamond F (215)
- Chrysolite F (238)
- Citrus Green F (337)
- Denim Blue F (266)
- Emerald F (205)
- Greige F (284)
- Iris F (219)
- Jet (280)
- Jet F (280)
- Light Amethyst F (212)
- Light Colorado Topaz F (246)
- Light Rose F (223)
- Light Sapphire F (211)
- Light Siam F (227)
- Light Topaz F (226)
- Light Turquoise F (263)
- Majestic Green F (336)
- Montana F (207)
- Rose F (209)

Crystal F (001)	■	■	■	■	■	■	■	■	■	■	■	■	■	■	■	■	■	■	■	■	■	■	■	■	■
Amethyst F (204)		■	■	■	■	■	■	■	■	■	■	■	■	■	■	■	■	■	■	■	■	■	■	■	■
Aquamarine F (202)	■	■	■	■	■	■	■	■	■	■	■	■	■	■	■	■	■	■	■	■	■	■	■	■	■
Black Diamond F (215)	■	■	■	■	■	■	■	■	■	■	■	■	■	■	■	■	■	■	■	■	■	■	■	■	■
Chrysolite F (238)		■	■	■	■	■	■	■	■	■	■	■	■	■	■	■	■	■	■	■	■	■	■	■	■
Citrus Green F (337)														■	■	■	■	■	■	■	■	■	■	■	■
Denim Blue F (266)		■	■	■	■	■	■	■	■	■	■	■	■	■	■	■	■	■	■	■	■	■	■	■	■
Emerald F (205)	■	■	■	■	■	■	■	■	■	■	■	■	■	■	■	■	■	■	■	■	■	■	■	■	■
Greige F (284)		■	■	■	■	■	■	■	■	■	■	■	■	■	■	■	■	■	■	■	■	■	■	■	■
Iris F (219)		■	■	■	■	■	■	■	■	■	■	■	■	■	■	■	■	■	■	■	■	■	■	■	■
Jet (280)		■	■	■	■	■	■	■	■	■	■	■	■	■	■	■	■	■	■	■	■	■	■	■	■
Jet F (280)	■	■	■	■	■	■	■	■	■	■	■	■	■	■	■	■	■	■	■	■	■	■	■	■	■
Light Amethyst F (212)		■	■	■	■	■	■	■	■	■	■	■	■	■	■	■	■	■	■	■	■	■	■	■	■
Light Colorado Topaz F (246)		■	■	■	■	■	■	■	■	■	■	■	■	■	■	■	■	■	■	■	■	■	■	■	■
Light Rose F (223)		■	■	■	■	■	■	■	■	■	■	■	■	■	■	■	■	■	■	■	■	■	■	■	■
Light Sapphire F (211)		■	■	■	■	■	■	■	■	■	■	■	■	■	■	■	■	■	■	■	■	■	■	■	■
Light Siam F (227)		■	■	■	■	■	■	■	■	■	■	■	■	■	■	■	■	■	■	■	■	■	■	■	■
Light Topaz F (226)		■	■	■	■	■	■	■	■	■	■	■	■	■	■	■	■	■	■	■	■	■	■	■	■
Light Turquoise F (263)		■	■	■	■	■	■	■	■	■	■	■	■	■	■	■	■	■	■	■	■	■	■	■	■
Majestic Green F (336)		■	■	■	■	■	■	■	■	■	■	■	■	■	■	■	■	■	■	■	■	■	■	■	■
Montana F (207)		■	■	■	■	■	■	■	■	■	■	■	■	■	■	■	■	■	■	■	■	■	■	■	■
Rose F (209)		■	■	■	■	■	■	■	■	■	■	■	■	■	■	■	■	■	■	■	■	■	■	■	■

1100
1028
1088

Size	PP 1	PP 2	PP 3	PP 4	PP 5	PP 6	PP 7	PP 8	PP 9	PP 10	PP 11	PP 12	PP 13	PP 14	PP 18	PP 21	PP 24	PP 27	PP 31	PP 32	SS 19	SS 24	SS 29	SS 34	SS 39
------	------	------	------	------	------	------	------	------	------	-------	-------	-------	-------	-------	-------	-------	-------	-------	-------	-------	-------	-------	-------	-------	-------

- Rose Peach F (262)
- Sapphire F (206)
- Scarlet F (276)
- Siam F (208)
- Silk F (391)
- Tanzanite F (539)
- Vintage Rose F (319)
- Violet F (371)
- Opal Colors**
- White Opal F (234)
- Swarovski ReCreated™ Colors**
- ReCreated™ Dark Jonquil F (1407)
- ReCreated™ Dark Sapphire F (1404)
- ReCreated™ Ice Blue F (1405)
- ReCreated™ Light Smoked Topaz F (1402)
- ReCreated™ Peridot F (1408)
- ReCreated™ Smoked Topaz F (1403)
- TCF™ Colors**
- Dark Orange F (1202 TCF™)
- Dark Rose F (1201 TCF™)
- Crystal Effects**
- Transparent Effects**
- Crystal Aurore Boreale F (001 AB)
- Crystal Golden Shadow F (001 GSHA)
- Crystal Ignite (001 IGNIT)
- Crystal Moonlight F (001 MOL)
- Crystal Silver Night F (001 SINI)
- Crystal Silver Shade F (001 SSHA)
- Metallic Effects**
- Crystal Aurum F (001 AUR)
- Crystal Lacquer^{PRO} Effects**
- Crystal Lacquer^{PRO} Ignite Effects**
- Crystal Agave Ignite (001 L1651)
- Crystal Dahlia Ignite (001 L1771)
- Crystal Dark Grey Ignite (001 L1111)
- Crystal Denim Ignite (001 L1661)
- Crystal Flamingo Ignite (001 L1621)
- Crystal Linen Ignite (001 L1641)
- Crystal Mango Ignite (001 L1521)

01

1100 1028 1088		Size	PP 1	PP 2	PP 3	PP 4	PP 5	PP 6	PP 7	PP 8	PP 9	PP 10	PP 11	PP 12	PP 13	PP 14	PP 18	PP 21	PP 24	PP 27	PP 31	PP 32	SS 19	SS 24	SS 29	SS 34	SS 39	
	Crystal Maroon Ignite (001 L160I)																											
	Crystal Orange Ignite (001 L159I)																											
	Crystal Orchid Ignite (001 L171I)																											
	Crystal Pine Green Ignite (001 L170I)																											
	Crystal Poppy Red Ignite (001 L179I)																											
	Crystal Purple Ignite (001 L161I)																											
	Crystal Sky Ignite (001 L163I)																											
	Crystal Soft Mint Ignite (001 L168I)																											
	Crystal Soft Rose Ignite (001 L167I)																											
	Crystal Soft Yellow Ignite (001 L169I)																											
	Crystal Teal Ignite (001 L178I)																											
Crystal Electric Lacquer^{PRO} Ignite Effects																												
	Crystal Electric Blue Ignite (001 L134I)																											
	Crystal Electric Green Ignite (001 L135I)																											
	Crystal Electric Orange Ignite (001 L136I)																											
	Crystal Electric Pink Ignite (001 L137I)																											
	Crystal Electric Violet Ignite (001 L148I)																											
	Crystal Electric White Ignite (001 L139I)																											
	Crystal Electric Yellow Ignite (001 L138I)																											
Color Effects																												
Metallic Effects																												
	Jet Hematite F (280 HEM)																											

1098 XIRIUS Light

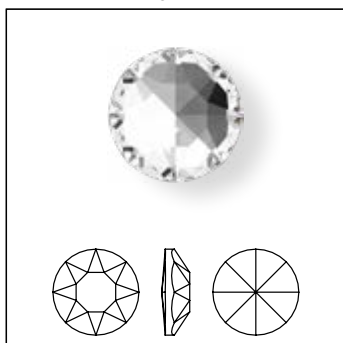

Size	PP 24	PP 31	SS 20	SS 24	SS 29	SS 34	SS 39
------	-------	-------	-------	-------	-------	-------	-------

Crystal

Crystal F (001)

Crystal Effects

Transparent Effects

Crystal Aurore Boreale F (001 AB)

Crystal Golden Shadow F (001 GSHA)

Crystal Silver Night F (001 SINI)

Crystal Silver Shade F (001 SSHA)

Crystal F (001)	■	■	■	■	■	■	■
Crystal Aurore Boreale F (001 AB)	■	■	■	■	■	■	■
Crystal Golden Shadow F (001 GSHA)	■	■	■	■	■	■	■
Crystal Silver Night F (001 SINI)	■	■	■	■	■	■	■
Crystal Silver Shade F (001 SSHA)	■	■	■	■	■	■	■

1122 Rivoli

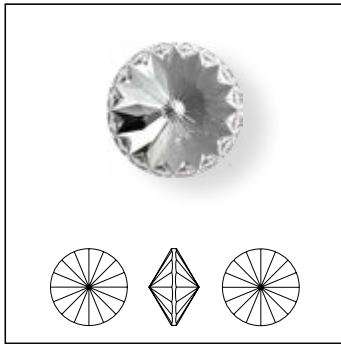

Size	SS 39	SS 47	12 mm	14 mm
------	-------	-------	-------	-------

Crystal

Crystal F (001)

Colors

Plain Colors

Amethyst F (204)

Aquamarine F (202)

Black Diamond F (215)

Citrus Green F (337)

Emerald F (205)

Iris F (219)

Jet (280)

Light Amethyst F (212)

Light Colorado Topaz F (246)

Light Rose F (223)

Light Sapphire F (211)

Light Siam F (227)

Light Topaz F (226)

Light Turquoise F (263)

Majestic Green F (336)

Montana F (207)

Rose F (209)

Rose Peach F (262)

Sapphire F (206)

Scarlet F (276)

Siam F (208)

Silk F (391)

Tanzanite F (539)

Vintage Rose F (319)

ReCreated™ Colors

ReCreated™ Dark Jonquil F (1407)

ReCreated™ Dark Sapphire F (1404)

ReCreated™ Ice Blue F (1405)

ReCreated™ Light Smoked Topaz F (1402)

ReCreated™ Peridot F (1408)

ReCreated™ Smoked Topaz F (1403)

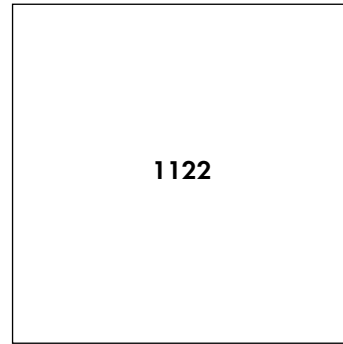

Size	SS 39	SS 47	12 mm	14 mm
------	-------	-------	-------	-------

Crystal Effects

Transparent Effects

Crystal Aurore Boreale F (001 AB)

Crystal Golden Shadow F (001 GSHA)

Crystal Silver Night F (001 SINI)

Crystal Silver Shade F (001 SSHA)

Metallic Effects

Crystal Aurum F (001 AUR)

Crystal Lacquer^{PRO} Effects

Crystal Lacquer^{PRO} Ignite Effects

Crystal Agave Ignite (001 L1651)

Crystal Dahlia Ignite (001 L1771)

Crystal Dark Grey Ignite (001 L1111)

Crystal Denim Ignite (001 L1661)

Crystal Flamingo Ignite (001 L1621)

Crystal Linen Ignite (001 L1641)

Crystal Mango Ignite (001 L1521)

Crystal Orchid Ignite (001 L1711)

Crystal Pine Green Ignite (001 L1701)

Crystal Poppy Red Ignite (001 L1791)

Crystal Sky Ignite (001 L1631)

Crystal Soft Mint Ignite (001 L1681)

Crystal Soft Rose Ignite (001 L1671)

Crystal Soft Yellow Ignite (001 L1691)

Crystal Teal Ignite (001 L1781)

Crystal Electric Lacquer^{PRO} Ignite Effects

Crystal Electric Blue Ignite (001 L1341)

Crystal Electric Green Ignite (001 L1351)

Crystal Electric Orange Ignite (001 L1361)

Crystal Electric Pink Ignite (001 L1371)

Crystal Electric Violet Ignite (001 L1481)

Crystal Electric White Ignite (001 L1391)

Crystal Electric Yellow Ignite (001 L1381)

1383 Fantasy Round Stone

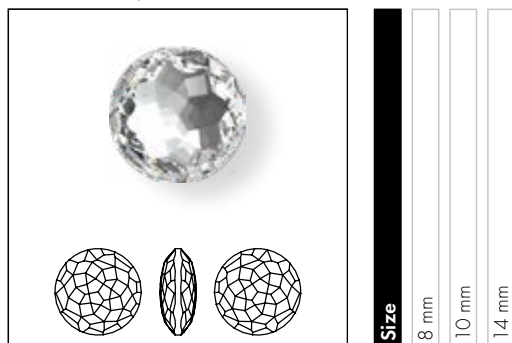

Size
8 mm
10 mm
14 mm

Crystal

Crystal F (001)

Colors

Plain Colors

- Amethyst F (204)
- Aquamarine F (202)
- Black Diamond F (215)
- Emerald F (205)
- Jet (280)
- Light Rose F (223)
- Majestic Green F (336)
- Montana F (207)
- Rose Peach F (262)
- Scarlet F (276)
- Vintage Rose F (319)

Opal Colors

White Opal (234)

ReCreated™ Colors

- ReCreated™ Dark Sapphire F (1404)
- ReCreated™ Ice Blue F (1405)

Crystal Effects

Transparent Effects

- Crystal Aurore Boreale F (001 AB)
- Crystal Golden Shadow F (001 GSHA)
- Crystal Ignite (001 IGNIT)
- Crystal Silver Night (001 SINI)

Metallic Effects

Crystal Aurum F (001 AUR)

Crystal Lacquer^{PRO} Effects

Crystal Lacquer^{PRO} Ignite Effects

- Crystal Agave Ignite (001 L165I)
- Crystal Dahlia Ignite (001 L177I)
- Crystal Dark Grey Ignite (001 L111I)
- Crystal Denim Ignite (001 L166I)
- Crystal Flamingo Ignite (001 L162I)
- Crystal Linen Ignite (001 L164I)
- Crystal Mango Ignite (001 L152I)
- Crystal Orchid Ignite (001 L171I)
- Crystal Pine Green Ignite (001 L170I)

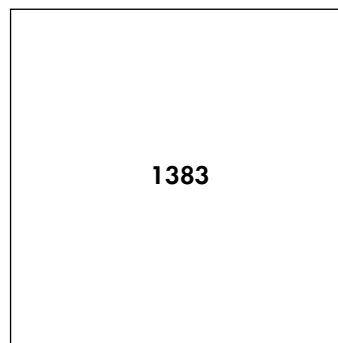

Size
8 mm
10 mm
14 mm

- Crystal Poppy Red Ignite (001 L179I)
- Crystal Sky Ignite (001 L163I)
- Crystal Soft Mint Ignite (001 L168I)
- Crystal Soft Rose Ignite (001 L167I)
- Crystal Soft Yellow Ignite (001 L169I)
- Crystal Teal Ignite (001 L178I)
- Crystal Electric Lacquer^{PRO} Ignite Effects**
- Crystal Electric Blue Ignite (001 L134I)
- Crystal Electric Green Ignite (001 L135I)
- Crystal Electric Orange Ignite (001 L136I)
- Crystal Electric Pink Ignite (001 L137I)
- Crystal Electric Violet Ignite (001 L148I)
- Crystal Electric White Ignite (001 L139I)
- Crystal Electric Yellow Ignite (001 L138I)
- Color Effects**
- Transparent Effects**
- Amethyst Ignite (204 IGNIT)
- Aquamarine Ignite (202 IGNIT)
- Emerald Ignite (205 IGNIT)
- Rose Peach Ignite (262 IGNIT)
- Scarlet Ignite (276 IGNIT)
- Vintage Rose Ignite (319 IGNIT)

1400 Dome Round Stone

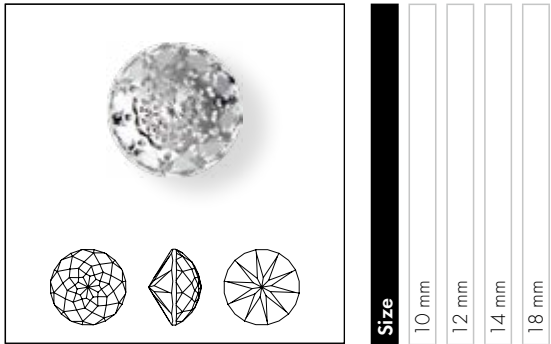

Crystal	10 mm	12 mm	14 mm	18 mm
Crystal F (001)	■	■	■	■
Colors				
Plain Colors				
Aquamarine F (202)	■	■	■	■
Emerald F (205)	■	■	■	■
Iris F (219)	■	■	■	■
Jet (280)	■	■	■	■
Light Colorado Topaz F (246)	■	■	■	■
Scarlet F (276)	■	■	■	■
Crystal Effects				
Transparent Effects				
Crystal Aurore Boreale F (001 AB)	■	■	■	■
Crystal Bermuda Blue F (001 BB)	■	■	■	■
Crystal Paradise Shine F (001 PARSH)	■	■	■	■

1401 Rose Cut Round Stone

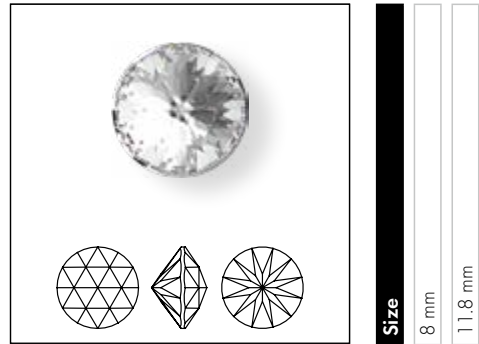

Crystal	8 mm	11.8 mm
Crystal F (001)	■	■
Colors		
Plain Colors		
Vintage Rose F (319)	■	■
Opal Colors		
Rose Water Opal F (395)	■	■
White Opal F (234)	■	■
Crystal Effects		
Transparent Effects		
Crystal Aurore Boreale F (001 AB)	■	■
Crystal Golden Shadow F (001 GSHA)	■	■

Product Details

Article Size	Packing Unit = Minimum Order Quantity in Pieces	Average Net Weight in Gram per Packing Unit Crystal (001)	Average Gross Weight in Gram per Packing Unit Crystal (001)
1028			
PP 2	1,440	0.7	11.6
PP 3	1,440	1.1	11.8
PP 4	1,440	1.4	12.2
PP 5	1,440	1.8	12.6
PP 6	1,440	2.1	13.3
PP 7	1,440	2.3	13.6
PP 8	1,440	2.8	14.8
PP 9	1,440	3.4	17.7
PP 10	1,440	3.8	15.2
PP 11	1,440	4.7	16.4
PP 12	1,440	5.6	17.5
PP 13	1,440	6.7	19.2
1088			
PP 14	1,440	7.1	18.1
PP 18	1,440	12.0	23.8
PP 21	1,440	15.8	29.6
PP 24	1,440	24.4	36.8
PP 27	1,440	30.2	46.9
PP 31	1,440	49.2	64.2
PP 32	1,440	53.7	69.9
SS 19	1,440	66.2	91.5
SS 24	720	61.1	79.3
SS 29	288	47.4	71.9
SS 34	144	30.2	62.1
SS 39	144	52.9	74.7
1098			
PP 24	1,440	20.96	31.16
PP 31	1,440	41.13	51.33
SS 20	720	36.58	46.78
SS 24	720	56.14	66.34
SS 29	288	34.19	51.37
SS 34	144	28.66	45.84
SS 39	144	39.51	56.69
1100			
PP 1	1,440	0.6	9.1
1122			
SS 39	144	37.1	55.2
SS 47	288	158.6	215.9
12 mm	144	99.5	142.2
14 mm	144	167.4	225.9

Article Size	Packing Unit = Minimum Order Quantity in Pieces	Average Net Weight in Gram per Packing Unit Crystal (001)	Average Gross Weight in Gram per Packing Unit Crystal (001)
1383			
8 mm	216	68.6	95.3
10 mm	96	56.6	81.5
14 mm	48	77.7	102
1400			
10 mm	72	42.7	64.6
12 mm	72	75.0	96.9
14 mm	36	59.5	85.9
18 mm	24	84.4	103.3
1401			
8 mm	144	50.1	71.9
11.8 mm	72	75.8	97.8



Flat Backs No Hotfix

Flat Backs No Hotfix are crystals with platinum-backed brilliance and effortless versatility. Available in an array of sizes, colors, shapes, and cuts, they can be easily applied to various carrier materials using standard one- or two-component glues.









The Article 2088 XIRIUS Rose redefines radiance as the highlight of the product group, with our revolutionary multi-layer cutting technology taking brilliance one step further to create the iconic XIRIUS design. Reflecting light with unmatched depth and clarity it sets a new market standard for superior shine.























Continuing our commitment to exceptional innovation, the XIRIUS Star Rose 2100 was launched in February 2025. Versatile and striking, it elevates modern aesthetics with sartorial elegance and symbolic depth. With its minimal aesthetic, the celestial-inspired cut transforms any design into a statement of modern elegance, casting a sense of mystery and magic across every silhouette.

These captivating crystals illustrate Swarovski's legendary craftsmanship – engineered with the highest precision in table size and diameter to ensure brilliance is never compromised.







Colors & Effects

Colors

-  Crystal 001
-  White Opal 234
-  Light Silk 261
-  Silk 391
-  Light Peach 362
-  Vintage Rose 319
-  Blush Rose 257
-  Light Rose 223
-  Rose Peach 262
-  Padparadscha 542
-  Indian Pink 289
-  Rose 209
-  Fuchsia 502
-  Light Siam 227
-  Scarlet 276
-  Indian Siam 327
-  Siam 208
-  Ruby 501
-  Burgundy 515
-  Amethyst 204
-  Iris 219
-  Light Amethyst 212
-  Provence Lavender 283
-  Tanzanite 539
-  Purple Velvet 277
-  Aquamarine 202

-  Light Sapphire 211
-  Sapphire 206
-  Capri Blue 243
-  Majestic Blue 296
-  Cobalt 369
-  Dark Indigo 288
-  Montana 207
-  Denim Blue 266
-  Indicolite 379
-  Light Turquoise 263
-  Blue Zircon 229
-  Erinite 360
-  Chrysolite 238
-  Citrus Green 337
-  Fern Green 291
-  Majestic Green 336
-  Emerald 205
-  Jonquil 213
-  Light Topaz 226
-  Light Colorado Topaz 246
-  Topaz 203
-  Greige 284
-  Black Diamond 215
-  Graphite 253
-  Jet 280



Swarovski ReCreated™ Colors

-  ReCreated™ Ice Blue 1405
-  ReCreated™ Dark Sapphire 1404
-  ReCreated™ Peridot 1408
-  ReCreated™ Dark Jonquil 1407
-  ReCreated™ Light Smoked Topaz 1402
-  ReCreated™ Smoked Topaz 1403

TCF™ Colors

-  Dark Rose 1201 TCF™
-  Dark Orange 1202 TCF™



















Effects

-  Crystal Moonlight 001 MOL
-  Crystal Shimmer 001 SHIM
-  Crystal Aureore Boreale 001 AB
-  Crystal Vitrail Light 001 VL
-  Crystal Paradise Shine 001 PARSH
-  Crystal Vitrail Medium 001 VM
-  Crystal Volcano 001 VOL
-  Crystal Heliotrope 001 HEL
-  Crystal Bermuda Blue 001 BBL
-  Crystal Blue Shade 001 BLSH
-  Crystal Golden Shadow 001 GSHA
-  Crystal Metallic Sunshine 001 METSH
-  Crystal Aurum 001 AUR
-  Crystal Rose Gold 001 ROGL







-  Crystal Light Chrome
001 LTCH
-  Crystal Silver Shade
001 SSHA
-  Crystal Silver Night
001 SINI
-  Jet Hematite
280 HEM

Crystal Lacquer^{PRO} Effects











Crystal Lacquer^{PRO} Ignite Effects

-  Crystal Linen Ignite
001 L164I
-  Crystal Soft Rose Ignite*
001 L167I
-  Crystal Flamingo Ignite
001 L162I
-  Crystal Dahlia Ignite
001 L177I
-  Crystal Orange Ignite
001 L159I
-  Crystal Maroon Ignite
001 L160I
-  Crystal Poppy Red Ignite
001 L179I
-  Crystal Orchid Ignite
001 L171I
-  Crystal Purple Ignite
001 L161I
-  Crystal Sky Ignite
001 L163I
-  Crystal Denim Ignite
001 L166I
-  Crystal Teal Ignite
001 L178I
-  Crystal Pine Green Ignite
001 L170I
-  Crystal Agave Ignite
001 L165I
-  Crystal Soft Mint Ignite
001 L168I
-  Crystal Soft Yellow Ignite
001 L169I
-  Crystal Mango Ignite
001 L152I
-  Crystal Dark Grey Ignite
001 L111I



Crystal Electric Lacquer^{PRO} Ignite Effects

-  Crystal Electric White Ignite
001 L139I
-  Crystal Electric Orange Ignite
001 L136I
-  Crystal Electric Pink Ignite
001 L137I
-  Crystal Electric Violet Ignite
001 L148I
-  Crystal Electric Blue Ignite
001 L134I
-  Crystal Electric Green Ignite
001 L135I
-  Crystal Electric Yellow Ignite
001 L138I

Shimmer Effects

-  Silk Shimmer
391 SHIM
-  Light Rose Shimmer
223 SHIM
-  Fuchsia Shimmer
502 SHIM
-  Light Siam Shimmer
227 SHIM
-  Tanzanite Shimmer
539 SHIM
-  Light Sapphire Shimmer
211 SHIM
-  Blue Zircon Shimmer
229 SHIM
-  ReCreated™ Peridot Shimmer*
1408 SHIM
-  Topaz Shimmer
203 SHIM
-  Black Diamond Shimmer
215 SHIM

AB Effects

-  Light Rose Aurore Boreale
223 AB
-  Light Siam Aurore Boreale
227 AB
-  Sapphire Aurore Boreale
206 AB
-  Jonquil Aurore Boreale
213 AB

Nightfall Effects

-  Siam Nightfall
208 NIFA
-  Capri Blue Nightfall
243 NIFA
-  Emerald Nightfall
205 NIFA
-  Graphite Nightfall
253 NIFA

*this color does not exist for 2088, but for other Flat Backs. For more details, please see the product matrix on the respective items.

Numerical Order

001	Crystal	001 VM	Crystal Vitrail Medium	263	Light Turquoise
001 AB	Crystal Aurore Boreale	001 VOL	Crystal Volcano	266	Denim Blue
001 AUR	Crystal Aurum	202	Aquamarine	276	Scarlet
001 BBL	Crystal Bermuda Blue	203 SHIM	Topaz Shimmer	277	Purple Velvet
001 BLSH	Crystal Blue Shade	203	Topaz	280	Jet
001 GSHA	Crystal Golden Shadow	204	Amethyst	280 HEM	Jet Hematite
001 HEL	Crystal Heliotrope	205 NIFA	Emerald Nightfall	283	Provence Lavender
001 L1111	Crystal Dark Grey Ignite	205	Emerald	284	Greige
001 L1341	Crystal Electric Blue Ignite	206 AB	Sapphire Aurore Boreale	288	Dark Indigo
001 L1351	Crystal Electric Green Ignite	206	Sapphire	289	indian Pink
001 L1361	Crystal Electric Orange Ignite	207	Montana	291	Fern Green
001 L1371	Crystal Electric Pink Ignite	208 NIFA	Siam Nightfall	296	Majestic Blue
001 L1381	Crystal Electric Yellow Ignite	208	Siam	319	Vintage Rose
001 L1391	Crystal Electric White Ignite	209	Rose	327	indian Siam
001 L1481	Crystal Electric Violet Ignite	211 SHIM	Light Sapphire Shimmer	336	Majestic Green
001 L1521	Crystal Mango Ignite	211	Light Sapphire	337	Citrus Green
001 L1591	Crystal Orange Ignite	212	Light Amethyst	360	Erinite
001 L1601	Crystal Maroon Ignite	213 AB	Jonquil Aurore Boreale	362	Light Peach
001 L1611	Crystal Purple Ignite	213	Jonquil	369	Cobalt
001 L1621	Crystal Flamingo Ignite	215 SHIM	Black Diamond Shimmer	379	Indicolite
001 L1631	Crystal Sky Ignite	215	Black Diamond	391 SHIM	Silk Shimmer
001 L1641	Crystal Linen Ignite	219	Iris	391	Silk
001 L1651	Crystal Agave Ignite	223 AB	Light Rose Aurore Boreale	501	Ruby
001 L1661	Crystal Denim Ignite	223 SHIM	Light Rose Shimmer	502 SHIM	Fuchsia Shimmer
001 L1671	Crystal Soft Rose Ignite	223	Light Rose	502	Fuchsia
001 L1681	Crystal Soft Mint Ignite	226	Light Topaz	515	Burgundy
001 L1691	Crystal Soft Yellow Ignite	227 AB	Light Siam Aurore Boreale	539 SHIM	Tanzanite Shimmer
001 L1701	Crystal Pine Green Ignite	227 SHIM	Light Siam Shimmer	539	Tanzanite
001 L1711	Crystal Orchid Ignite	227	Light Siam	542	Padparadscha
001 L1771	Crystal Dahlia Ignite	229 SHIM	Blue Zircon Shimmer	1201 TCF™	Dark Rose
001 L1781	Crystal Teal Ignite	229	Blue Zircon	1202 TCF™	Dark Orange
001 L1791	Crystal Poppy Red Ignite	234	White Opal	1402	ReCreated™ Light Smoked Topaz
001 LTCH	Crystal Light Chrome	238	Chrysolite	1403	ReCreated™ Smoked Topaz
001 METSH	Crystal Metallic Sunshine	243 NIFA	Capri Blue Nightfall	1404	ReCreated™ Dark Sapphire
001 MOL	Crystal Moonlight	243	Capri Blue	1405	ReCreated™ Ice Blue
001 PARSH	Crystal Paradise Shine	246	Light Colorado Topaz	1407	ReCreated™ Dark Jonquil
001 ROGL	Crystal Rose Gold	253 NIFA	Graphite Nightfall	1408	ReCreated™ Peridot
001 SHIM	Crystal Shimmer	253	Graphite	1408 SHIM	ReCreated™ Peridot Shimmer
001 SINI	Crystal Silver Night	257	Blush Rose		
001 SSHA	Crystal Silver Shade	261	Light Silk		
001 VL	Crystal Vitrail Light	262	Rose Peach		

Alphabetical Order

Amethyst (204)	Crystal Pine Green Ignite (001 L170I)	Light Rose Shimmer (223 SHIM)
Aquamarine (202)	Crystal Poppy Red Ignite (001 L179I)	Light Sapphire (211)
Black Diamond (215)	Crystal Purple Ignite (001 L161I)	Light Sapphire Shimmer (211 SHIM)
Black Diamond Shimmer (215 SHIM)	Crystal Rose Gold (001 ROGL)	Light Siam (227)
Blue Zircon (229)	Crystal Shimmer (001 SHIM)	Light Siam Aurore Boreale (227 AB)
Blue Zircon Shimmer (229 SHIM)	Crystal Silver Night (001 SINI)	Light Siam Shimmer (227 SHIM)
Blush Rose (257)	Crystal Silver Shade (001 SSHA)	Light Silk (261)
Burgundy (515)	Crystal Soft Mint Ignite (001 L168I)	Light Topaz (226)
Capri Blue (243)	Crystal Soft Rose Ignite (001 L167I)	Light Turquoise (263)
Capri Blue Nightfall (243 NIFA)	Crystal Soft Yellow Ignite (001 L169I)	Majestic Blue (296)
Chrysolite (238)	Crystal Sky Ignite (001 L163I)	Majestic Green (336)
Citrus Green (337)	Crystal Teal Ignite (001 L178I)	Montana (207)
Cobalt (369)	Crystal Vitrail Light (001 VL)	Padparadscha (542)
Crystal (001)	Crystal Vitrail Medium (001 VM)	Provence Lavender (283)
Crystal Agave Ignite (001 L165I)	Crystal Volcano (001 VOL)	Purple Velvet (277)
Crystal Aurore Boreale (001 AB)	Dark Indigo (288)	ReCreated™ Dark Jonquil (1407)
Crystal Aurum (001 AUR)	Dark Orange (1202 TCF™)	ReCreated™ Dark Sapphire (1404)
Crystal Bermuda Blue (001 BBL)	Dark Rose (1201 TCF™)	ReCreated™ Ice Blue (1405)
Crystal Blue Shade (001 BLSH)	Denim Blue (266)	ReCreated™ Light Smoked Topaz (1402)
Crystal Dahlia Ignite (001 L177I)	Emerald (205)	ReCreated™ Peridot (1408)
Crystal Dark Grey Ignite (001 L111I)	Emerald Nightfall (205 NIFA)	ReCreated™ Peridot Shimmer (1408 SHIM)
Crystal Denim Ignite (001 L166I)	Erinite (360)	ReCreated™ Smoked Topaz (1403)
Crystal Electric Blue Ignite (001 L134I)	Fern Green (291)	Rose (209)
Crystal Electric Green Ignite (001 L135I)	Fuchsia (502)	Rose Peach (262)
Crystal Electric Orange Ignite (001 L136I)	Fuchsia Shimmer (502 SHIM)	Ruby (501)
Crystal Electric Pink Ignite (001 L137I)	Graphite (253)	Sapphire (206)
Crystal Electric Violet Ignite (001 L148I)	Graphite Nightfall (253 NIFA)	Sapphire Aurore Boreale (206 AB)
Crystal Electric White Ignite (001 L139I)	Greige (284)	Scarlet (276)
Crystal Electric Yellow Ignite (001 L138I)	Indian Pink (289)	Siam (208)
Crystal Flamingo Ignite (001 L162I)	Indian Siam2 (327)	Siam Nightfall (208 NIFA)
Crystal Golden Shadow (001 GSHA)	Indicolite (379)	Silk (391)
Crystal Heliotrope (001 HEL)	Iris (219)	Silk Shimmer (391 SHIM)
Crystal Light Chrome (001 LTCH)	Jet (280)	Tanzanite (539)
Crystal Linen Ignite (001 L164I)	Jet Hematite (280 HEM)	Tanzanite Shimmer (539 SHIM)
Crystal Mango Ignite (001 L152I)	Jonquil (213)	Topaz (203)
Crystal Maroon Ignite (001 L160I)	Jonquil Aurore Boreale (213 AB)	Topaz Shimmer (203 SHIM)
Crystal Metallic Sunshine (001 METSH)	Light Amethyst (212)	Vintage Rose (319)
Crystal Moonlight (001 MOL)	Light Colorado Topaz (246)	White Opal (234)
Crystal Orange Ignite (001 L159I)	Light Peach (362)	
Crystal Orchid Ignite (001 L171I)	Light Rose (223)	
Crystal Paradise Shine (001 PARSH)	Light Rose Aurore Boreale (223 AB)	

For details on available colors and effects for each article within the product groups, please see the product matrix of the respective item in the Collection 2026.



The plating resistance of effects is tested according to Swarovski's plating guidelines (SWAROVSKI.COM/S-PROFESSIONALS). Customers are advised to carry out their own tests if their plating parameters diverge from Swarovski plating guidelines.

Colors and effects can appear different when illuminated with different light sources. Swarovski uses standard light source D65 for color decision and comparison. Slight changes in shades are unavoidable. Colors may vary according to cut and foiling.

The composition of Advanced Crystal is compliant with regulatory industry norms and laws regarding the restriction or prohibition of certain substances in the most relevant segments of our customers. Please note that the compliance of the colors Light Siam and Siam varies according to certain industry regulations. Those regulations are indicated with * in the compliance overview. Indian Siam, Ruby and Scarlet (option to Lt. Siam) conform to all CLEAR-lists. For further information please visit swarovski.com/s-professionals

© 2026 D. Swarovski Distribution GmbH

Summary

1 2 3		1098 PP 24 (SS 12), PP 31 (SS 16) SS 20, 24, 29, 34, 39	1 2		2304 6x1.7, 10x2.8, 14x3.9 mm	1 2		2711 3.3 mm
		2000 SS 3, 4			2400 2.2, 3, 4, 6 mm			2715 3, 4 mm
		2019 4x4, 5x5, 6x6 mm			2471 5, 7, 10 mm			2716 5 mm
		2035 6, 10, 14, 20, 30, 40 mm			2472 5, 7, 10 mm			2738 10x5, 12x6 mm
		2058 SS 5, 6, 7, 8, 9, 10			2483 10, 25 mm			2739 5.8x5.3, 7x6.5 mm
		2088 SS 12, 14, 16, 20, 24, 30, 34, 40, 48			2493 8, 10, 20 mm			2740 8.3x8.3, 10x10 mm
		2100 SS 12, 16, 20, 30, 34, 40, 48			2510 3.7x1.9 mm			2754 4,6 mm
		2200 4x2, 8x4 mm			2520 8x6, 10x8, 14x10 mm			2770 6x3.5, 12x7 mm
		2201 4x1.8, 8x3.5, 14x6 mm			2555 8x2.6, 12x4, 15x5 mm			2771 6.4x4.2, 8.6x5.6, 12.9x8.3 mm
		2205 7.5, 10, 14 mm			2602 3.7x2.5, 8x5.5, 14x10 mm			2772 6.5x2.1, 8.6x2.8, 12.9x4.2 mm
		2300 8x4.8, 10x6 mm			2603 4x3, 8x6, 14x10 mm			2773 5x3, 6.6x3.9, 9.9x5.9 mm
		2303 8x5, 14x9 mm			2709 10x6, 13x8 mm			2774 6.3x4.2, 8.3x5.6, 12.5x8.4 mm

1 Top view 2 Side view 3 Back view

1 2



2775
5x4.2, 6.7x5.6,
10x8.4 mm



2776
8.2x4.2, 11x5.6,
16.5x8.4 mm



2777
5x4.2, 6.7x5.6,
10x8.4 mm



2808
3.6, 6, 10, 14 mm



2813
8x5.5 mm



2816
5 mm



2854
8, 12 mm



2856
10x7.5, 14x10.5, 18x14 mm

02

1098 XIRIUS Light

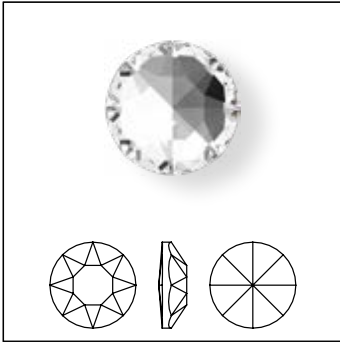

Size	PP 24	PP 31	SS 20	SS 24	SS 29	SS 34	SS 39
------	-------	-------	-------	-------	-------	-------	-------

Crystal

Crystal F (001)

Crystal Effects

Transparent Effects

Crystal Aurore Boreale F (001 AB)

Crystal Golden Shadow F (001 GSHA)

Crystal Silver Night F (001 SINI)

Crystal Silver Shade F (001 SSHA)

Crystal F (001)	■	■	■	■	■	■	■
Crystal Aurore Boreale F (001 AB)	■	■	■	■	■	■	■
Crystal Golden Shadow F (001 GSHA)	■	■	■	■	■	■	■
Crystal Silver Night F (001 SINI)	■	■	■	■	■	■	■
Crystal Silver Shade F (001 SSHA)	■	■	■	■	■	■	■

2000 Rose

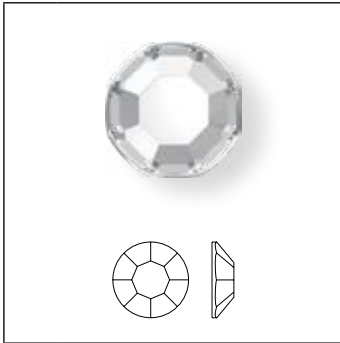

Size SS 3, 4

2058 XILION Rose

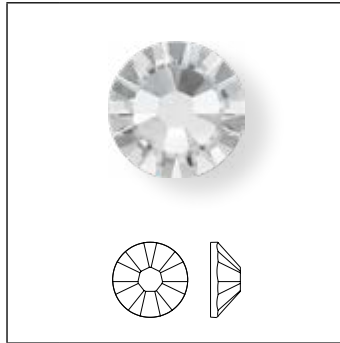

Size SS 5, 6, 7, 8, 9, 10

2088 XIRIUS Rose

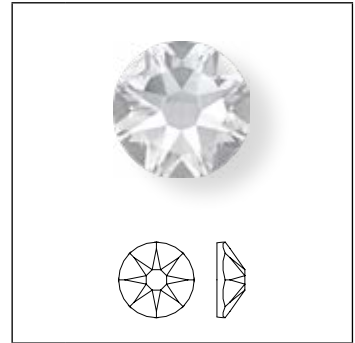

























Size SS 12, 14, 16, 20, 24, 30, 34, 40, 48

	2000 Rose		2058 XILION Rose							2088 XIRIUS Rose									
	SS 3	SS 4	SS 5	SS 6	SS 7	SS 8	SS 9	SS 10	SS 12	SS 14	SS 16	SS 20	SS 24	SS 30	SS 34	SS 40	SS 48		
Crystal																			
Crystal F (001)	■	■	■	■	■	■	■	■	■	■	■	■	■	■	■	■	■		
Colors																			
Plain Colors																			
Amethyst F (204)	■		■	■	■	■	■	■	■	■	■	■	■	■	■	■	■		
Aquamarine F (202)	■		■	■	■	■	■	■	■	■	■	■	■	■	■	■	■		
Black Diamond F (215)	■		■	■	■	■	■	■	■	■	■	■	■	■	■	■	■		
Blue Zircon F (229)			■	■	■	■	■	■	■	■	■	■	■	■	■	■	■		
Blush Rose F (257)			■	■	■	■	■	■	■	■	■	■	■	■	■	■	■		
Burgundy F (515)			■	■	■	■	■	■	■	■	■	■	■	■	■	■	■		
Capri Blue F (243)	■		■	■	■	■	■	■	■	■	■	■	■	■	■	■	■		
Chrysolite F (238)			■	■	■	■	■	■	■	■	■	■	■	■	■	■	■		
Citrus Green F (337)			■	■	■	■	■	■	■	■	■	■	■	■	■	■	■		
Cobalt F (369)			■	■	■	■	■	■	■	■	■	■	■	■	■	■	■		
Dark Indigo F (288)	■		■	■	■	■	■	■	■	■	■	■	■	■	■	■	■		
Denim Blue F (266)			■	■	■	■	■	■	■	■	■	■	■	■	■	■	■		
Emerald F (205)			■	■	■	■	■	■	■	■	■	■	■	■	■	■	■		
Erinite F (360)			■	■	■	■	■	■	■	■	■	■	■	■	■	■	■		
Fern Green F (291)	■		■	■	■	■	■	■	■	■	■	■	■	■	■	■	■		
Fuchsia F (502)			■	■	■	■	■	■	■	■	■	■	■	■	■	■	■		
Graphite F (253)			■	■	■	■	■	■	■	■	■	■	■	■	■	■	■		
Greige F (284)			■	■	■	■	■	■	■	■	■	■	■	■	■	■	■		

		2000		2058		2088													
		Size	2000 Rose	2058 XILLION Rose	2088 XIRIUS Rose														
			SS 3	SS 4	SS 5	SS 6	SS 7	SS 8	SS 9	SS 10	SS 12	SS 14	SS 16	SS 20	SS 24	SS 30	SS 34	SS 40	SS 48
Indian Pink F (289)			■		■	■	■	■			■	■	■			■	■		
Indian Siam F (327)			■		■	■	■	■			■	■	■			■	■		
Indicolite F (379)					■	■	■	■			■	■	■			■	■		
Iris F (219)					■	■	■	■			■	■	■			■	■		
Jet (280)			■		■	■	■	■			■	■	■			■	■		
Jet F (280)			■		■	■	■	■	■	■	■	■	■			■	■	■	■
Jonquil F (213)			■		■	■	■	■			■	■	■			■	■		
Light Amethyst F (212)					■	■	■	■			■	■	■			■	■		
Light Colorado Topaz F (246)			■		■	■	■	■			■	■	■			■	■	■	■
Light Peach F (362)			■		■	■	■	■			■	■	■			■	■		
Light Rose F (223)			■		■	■	■	■			■	■	■			■	■	■	■
Light Sapphire F (211)			■		■	■	■	■			■	■	■			■	■	■	■
Light Siam F (227)			■		■	■	■	■			■	■	■			■	■	■	■
Light Silk F (261)					■	■	■	■			■	■	■			■	■	■	■
Light Topaz F (226)					■	■	■	■			■	■	■			■	■	■	■
Light Turquoise F (263)					■	■	■	■			■	■	■			■	■	■	■
Majestic Blue F (296)					■	■	■	■			■	■	■			■	■	■	■
Majestic Green F (336)					■	■	■	■			■	■	■			■	■	■	■
Montana F (207)			■		■	■	■	■			■	■	■			■	■	■	■
Padparadscha F (542)					■	■	■	■			■	■	■			■	■	■	■
Provence Lavender F (283)					■	■	■	■			■	■	■			■	■	■	■
Purple Velvet F (277)					■	■	■	■			■	■	■			■	■	■	■
Rose F (209)			■		■	■	■	■			■	■	■			■	■	■	■
Rose Peach F (262)			■		■	■	■	■			■	■	■			■	■	■	■
Ruby F (501)					■	■	■	■			■	■	■			■	■	■	■
Sapphire F (206)			■		■	■	■	■			■	■	■			■	■	■	■
Scarlet F (276)					■	■	■	■			■	■	■			■	■	■	■
Siam F (208)					■	■	■	■			■	■	■			■	■	■	■
Silk F (391)			■		■	■	■	■			■	■	■			■	■	■	■
Tanzanite F (539)			■		■	■	■	■			■	■	■			■	■	■	■
Topaz F (203)					■	■	■	■			■	■	■			■	■	■	■
Vintage Rose F (319)			■		■	■	■	■			■	■	■			■	■	■	■
Opal Colors																			
White Opal F (234)					■	■	■	■			■	■	■			■	■	■	■

2000 2058 2088		Size	2000 Rose	SS 3	SS 4	2058 XILLION Rose	SS 5	SS 6	SS 7	SS 8	SS 9	SS 10	2088 XIRIUS Rose	SS 12	SS 14	SS 16	SS 20	SS 24	SS 30	SS 34	SS 40	SS 48
Swarovski ReCreated™ Colors																						
	ReCreated™ Dark Jonquil F (1407)						■	■	■	■	■	■	■	■	■	■	■	■	■	■	■	■
	ReCreated™ Dark Sapphire F (1404)		■			■	■	■	■	■	■	■	■	■	■	■	■	■	■	■	■	■
	ReCreated™ Ice Blue F (1405)					■	■	■	■	■	■	■	■	■	■	■	■	■	■	■	■	■
	ReCreated™ Light Smoked Topaz F (1402)		■			■	■	■	■	■	■	■	■	■	■	■	■	■	■	■	■	■
	ReCreated™ Peridot F (1408)		■			■	■	■	■	■	■	■	■	■	■	■	■	■	■	■	■	■
	ReCreated™ Smoked Topaz F (1403)		■			■	■	■	■	■	■	■	■	■	■	■	■	■	■	■	■	■
TCF™ Colors																						
	Dark Orange F (1202 TCF™)		■			■	■	■	■	■	■	■	■	■	■	■	■	■	■	■	■	■
	Dark Rose F (1201 TCF™)		■			■	■	■	■	■	■	■	■	■	■	■	■	■	■	■	■	■
Crystal Effects																						
Transparent Effects																						
	Crystal Aurore Boreale F (001 AB)		■	■		■	■	■	■	■	■	■	■	■	■	■	■	■	■	■	■	■
	Crystal Bermuda Blue F (001 BBL)					■	■	■	■	■	■	■	■	■	■	■	■	■	■	■	■	■
	Crystal Blue Shade F (001 BLSH)					■	■	■	■	■	■	■	■	■	■	■	■	■	■	■	■	■
	Crystal Golden Shadow F (001 GSHA)		■			■	■	■	■	■	■	■	■	■	■	■	■	■	■	■	■	■
	Crystal Heliotrope F (001 HEL)					■	■	■	■	■	■	■	■	■	■	■	■	■	■	■	■	■
	Crystal Moonlight F (001 MOL)		■			■	■	■	■	■	■	■	■	■	■	■	■	■	■	■	■	■
	Crystal Paradise Shine F (001 PARSH)		■			■	■	■	■	■	■	■	■	■	■	■	■	■	■	■	■	■
	Crystal Shimmer F (001 SHIM)		■			■	■	■	■	■	■	■	■	■	■	■	■	■	■	■	■	■
	Crystal Silver Night F (001 SINI)		■			■	■	■	■	■	■	■	■	■	■	■	■	■	■	■	■	■
	Crystal Silver Shade F (001 SSHA)		■			■	■	■	■	■	■	■	■	■	■	■	■	■	■	■	■	■
	Crystal Vitrail Light F (001 VL)					■	■	■	■	■	■	■	■	■	■	■	■	■	■	■	■	■
	Crystal Vitrail Medium F (001 VM)					■	■	■	■	■	■	■	■	■	■	■	■	■	■	■	■	■
	Crystal Volcano F (001 VOL)					■	■	■	■	■	■	■	■	■	■	■	■	■	■	■	■	■
Metallic Effects																						
	Crystal Aurum F (001 AUR)		■			■	■	■	■	■	■	■	■	■	■	■	■	■	■	■	■	■
	Crystal Light Chrome F (001 LTCH)		■			■	■	■	■	■	■	■	■	■	■	■	■	■	■	■	■	■
	Crystal Metallic Sunshine F (001 METSH)		■			■	■	■	■	■	■	■	■	■	■	■	■	■	■	■	■	■
	Crystal Rose Gold F (001 ROGL)		■			■	■	■	■	■	■	■	■	■	■	■	■	■	■	■	■	■

2000 2058 2088		Size	2000 Rose			2058 XILLION Rose						2088 XIRIUS Rose									
			SS 3	SS 4		SS 5	SS 6	SS 7	SS 8	SS 9	SS 10	SS 12	SS 14	SS 16	SS 20	SS 24	SS 30	SS 34	SS 40	SS 48	
Crystal Lacquer^{PRO} Effects																					
Crystal Lacquer^{PRO} Ignite Effects																					
	Crystal Agave Ignite (001 L1651)					■	■	■				■	■	■			■				
	Crystal Dahlia Ignite (001 L1771)					■	■	■				■	■	■			■				
	Crystal Dark Grey Ignite (001 L1111)					■	■	■				■	■	■			■				
	Crystal Denim Ignite (001 L1661)					■	■	■				■	■	■			■				
	Crystal Flamingo Ignite (001 L1621)					■	■	■				■	■	■			■				
	Crystal Linen Ignite (001 L1641)					■	■	■				■	■	■			■				
	Crystal Mango Ignite (001 L1521)					■	■	■				■	■	■			■				
	Crystal Maroon Ignite (001 L1601)					■	■	■				■	■	■			■				
	Crystal Orange Ignite (001 L1591)					■	■	■				■	■	■			■				
	Crystal Orchid Ignite (001 L1711)					■	■	■				■	■	■			■				
	Crystal Pine Green Ignite (001 L1701)					■	■	■				■	■	■			■				
	Crystal Poppy Red Ignite (001 L1791)					■	■	■				■	■	■			■				
	Crystal Purple Ignite (001 L1611)					■	■	■				■	■	■			■				
	Crystal Sky Ignite (001 L1631)					■	■	■				■	■	■			■				
	Crystal Soft Mint Ignite (001 L1681)					■	■	■				■	■	■			■				
	Crystal Soft Rose Ignite (001 L1671)					■	■	■				■	■	■			■				
	Crystal Soft Yellow Ignite (001 L1691)					■	■	■				■	■	■			■				
	Crystal Teal Ignite (001 L1781)					■	■	■				■	■	■			■				
Crystal Electric Lacquer^{PRO} Ignite Effects																					
	Crystal Electric Blue Ignite (001 L1341)					■	■	■				■	■	■			■				
	Crystal Electric Green Ignite (001 L1351)					■	■	■				■	■	■			■				
	Crystal Electric Orange Ignite (001 L1361)					■	■	■				■	■	■			■				
	Crystal Electric Pink Ignite (001 L1371)					■	■	■				■	■	■			■				
	Crystal Electric Violet Ignite (001 L1481)					■	■	■				■	■	■			■				
	Crystal Electric White Ignite (001 L1391)					■	■	■				■	■	■			■				
	Crystal Electric Yellow Ignite (001 L1381)					■	■	■				■	■	■			■				

<p style="text-align: center;">2000 2058 2088</p>		Size	2000 Rose		2058 XILION Rose						2088 XIRIUS Rose									
			SS 3	SS 4	SS 5	SS 6	SS 7	SS 8	SS 9	SS 10	SS 12	SS 14	SS 16	SS 20	SS 24	SS 30	SS 34	SS 40	SS 48	
Color Effects																				
Transparent Effects																				
	Black Diamond Shimmer F (215 SHIM)		■		■				■		■		■	■		■				
	Blue Zircon Shimmer F (229 SHIM)				■				■		■		■	■		■				
	Capri Blue Nightfall F (243 NIFA)				■				■		■		■	■		■	■			
	Emerald Nightfall F (205 NIFA)				■				■		■		■	■		■	■			
	Fuchsia Shimmer F (502 SHIM)				■				■		■		■	■		■				
	Graphite Nightfall F (253 NIFA)				■				■		■		■	■		■	■			
	Jonquil AB F (213 AB)		■		■				■		■		■	■		■				
	Light Rose AB F (223 AB)				■				■		■		■	■		■				
	Light Rose Shimmer F (223 SHIM)		■		■				■		■		■	■		■				
	Light Sapphire Shimmer F (211 SHIM)				■				■		■		■	■		■				
	Light Siam AB F (227 AB)		■		■				■		■		■	■		■				
	Light Siam Shimmer F (227 SHIM)		■		■				■		■		■	■		■				
	ReCreated™ Peridot Shimmer F (1408 SHIM)		■		■				■		■		■	■		■				
	Sapphire AB F (206 AB)		■		■				■		■		■	■		■				
	Siam Nightfall F (208 NIFA)				■				■		■		■	■		■	■			
	Silk Shimmer F (391 SHIM)		■		■				■		■		■	■		■				
	Tanzanite Shimmer F (539 SHIM)		■		■				■		■		■	■		■				
	Topaz Shimmer F (203 SHIM)				■				■		■		■	■		■				
Metallic Effects																				
	Jet Hematite F (280 HEM)		■		■		■		■		■		■	■		■	■	■	■	

2019 Round Spike Flat Back

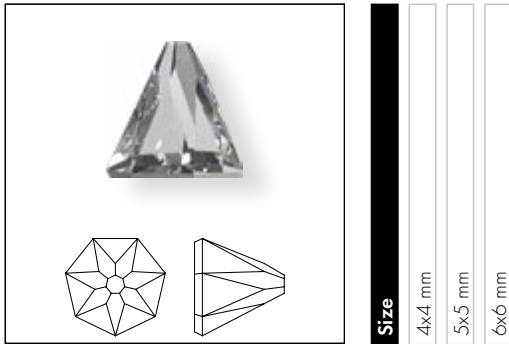

Size
4x4 mm
5x5 mm
6x6 mm

Crystal

Crystal F (001)

Crystal Effects

Transparent Effects

Crystal Aurore Boreale F (001 AB)

Crystal Blue Shade F (001 BLSH)

Crystal Golden Shadow F (001 GSHA)

Crystal Volcano F (001 VOL)

Color Effects

Transparent Effects

Black Diamond Shimmer F (215 SHIM)

Light Topaz Shimmer F (226 SHIM)

2035 Chessboard Circle Flat Back

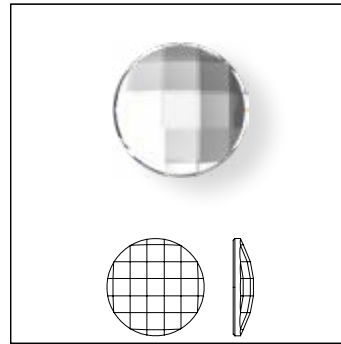

Size
6 mm
10 mm
14 mm
20 mm
30 mm
40 mm

Crystal

Crystal F (001)

Crystal Effects

Metallic Effects

Crystal Comet Argent Light V SI (001 CAVSI)

2100 XIRIUS Star Rose



Size	SS 12	SS 16	SS 20	SS 30	SS 34	SS 40	SS 48
------	-------	-------	-------	-------	-------	-------	-------

Crystal

Crystal F (001)

Colors

Plain Colors

Black Diamond F (215)

Graphite F (253)

Light Colorado Topaz F (246)

Light Rose F (223)

Light Siam F (227)

Light Silk F (261)

Majestic Green F (336)

Silk F (391)

ReCreated™ Colors

ReCreated™ Dark Jonquil F (1407)

ReCreated™ Dark Sapphire F (1404)

ReCreated™ Ice Blue F (1405)

TCF™ Colors

Dark Orange F (1202 TCF™)

Dark Rose F (1201 TCF™)

Crystal Effects

Transparent Effects

Crystal Aurore Boreale F (001 AB)

Crystal Blue Shade F (001 BLSH)

Crystal Golden Shadow F (001 GSHA)

Crystal Moonlight F (001 MOL)

Crystal Shimmer F (001 SHIM)

Crystal Silver Night F (001 SINI)

Crystal Silver Shade F (001 SSHA)

Metallic Effects

Crystal Light Chrome F (001 LTCH)

Crystal Metallic Sunshine F (001 METSH)

Color Effects

Metallic Effects

Jet Hematite F (280 HEM)

Crystal F (001)	■	■	■	■	■	■	■
Black Diamond F (215)	■	■	■	■	■	■	■
Graphite F (253)	■	■	■	■	■	■	■
Light Colorado Topaz F (246)	■	■	■	■	■	■	■
Light Rose F (223)	■	■	■	■	■	■	■
Light Siam F (227)	■	■	■	■	■	■	■
Light Silk F (261)	■	■	■	■	■	■	■
Majestic Green F (336)	■	■	■	■	■	■	■
Silk F (391)	■	■	■	■	■	■	■
ReCreated™ Dark Jonquil F (1407)	■	■	■	■	■	■	■
ReCreated™ Dark Sapphire F (1404)	■	■	■	■	■	■	■
ReCreated™ Ice Blue F (1405)	■	■	■	■	■	■	■
Dark Orange F (1202 TCF™)	■	■	■	■	■	■	■
Dark Rose F (1201 TCF™)	■	■	■	■	■	■	■
Crystal Aurore Boreale F (001 AB)	■	■	■	■	■	■	■
Crystal Blue Shade F (001 BLSH)	■	■	■	■	■	■	■
Crystal Golden Shadow F (001 GSHA)	■	■	■	■	■	■	■
Crystal Moonlight F (001 MOL)	■	■	■	■	■	■	■
Crystal Shimmer F (001 SHIM)	■	■	■	■	■	■	■
Crystal Silver Night F (001 SINI)	■	■	■	■	■	■	■
Crystal Silver Shade F (001 SSHA)	■	■	■	■	■	■	■
Crystal Light Chrome F (001 LTCH)	■	■	■	■	■	■	■
Crystal Metallic Sunshine F (001 METSH)	■	■	■	■	■	■	■
Jet Hematite F (280 HEM)	■	■	■	■	■	■	■

2200 Navette Flat Back

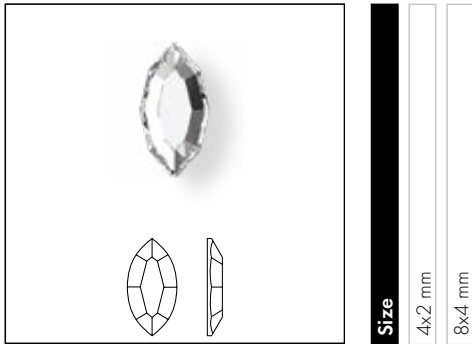

Size
4x2 mm
8x4 mm

Crystal	
Crystal F (001)	■ ■
Colors	
Plain Colors	
Aquamarine F (202)	■ ■
Black Diamond F (215)	■ ■
Emerald F (205)	■ ■
Jet (280)	■ ■
Light Colorado Topaz F (246)	■ ■
Light Rose F (223)	■ ■
Scarlet F (276)	■ ■
ReCreated™ Colors	
ReCreated™ Dark Jonquil F (1407)	■ ■
ReCreated™ Light Smoked Topaz F (1402)	■ ■
ReCreated™ Peridot F (1408)	■ ■
ReCreated™ Smoked Topaz F (1403)	■ ■
TCF™ Colors	
Dark Orange F (1202 TCF™)	■ ■
Crystal Effects	
Transparent Effects	
Crystal Aurore Boreale F (001 AB)	■ ■ ■
Crystal Golden Shadow F (001 GSHA)	■ ■ ■
Crystal Heliotrope F (001 HEL)	■ ■ ■
Crystal Shimmer F (001 SHIM)	■ ■ ■
Crystal Silver Shade F (001 SSHA)	■ ■ ■
Metallic Effects	
Crystal Aurum F (001 AUR)	■ ■

2201 Marquise Flat Back

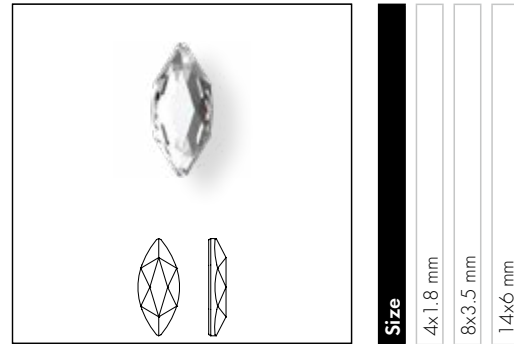

Size
4x1.8 mm
8x3.5 mm
14x6 mm

Crystal	
Crystal F (001)	■ ■ ■
Colors	
Plain Colors	
Aquamarine F (202)	■ ■ ■
Emerald F (205)	■ ■ ■
Graphite F (253)	■ ■ ■
Jet (280)	■ ■ ■
Sapphire F (206)	■ ■ ■
Scarlet F (276)	■ ■ ■
Vintage Rose F (319)	■ ■ ■
Crystal Effects	
Transparent Effects	
Crystal Aurore Boreale F (001 AB)	■ ■ ■
Crystal Golden Shadow F (001 GSHA)	■ ■ ■
Crystal Heliotrope F (001 HEL)	■ ■ ■
Crystal Shimmer F (001 SHIM)	■ ■ ■
Color Effects	
Transparent Effects	
Vintage Rose Shimmer F (319 SHIM)	■ ■ ■

2205 Flame Flat Back

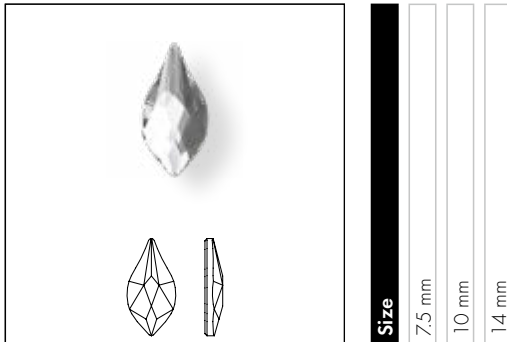

Crystal		
<input type="checkbox"/>	Crystal F (001)	<input type="checkbox"/>
Colors		
Plain Colors		
<input type="checkbox"/>	Light Siam F (227)	<input type="checkbox"/>
Opal Colors		
<input type="checkbox"/>	White Opal F (234)	<input type="checkbox"/>
TCF™ Colors		
<input type="checkbox"/>	Dark Orange F (1202 TCF™)	<input type="checkbox"/>
Crystal Effects		
Transparent Effects		
<input type="checkbox"/>	Crystal Aurore Boreale F (001 AB)	<input type="checkbox"/>
<input type="checkbox"/>	Crystal Golden Shadow F (001 GSHA)	<input type="checkbox"/>

2300 Drop Flat Back



Crystal		
<input type="checkbox"/>	Crystal F (001)	<input type="checkbox"/>

02

2303 Pear Flat Back

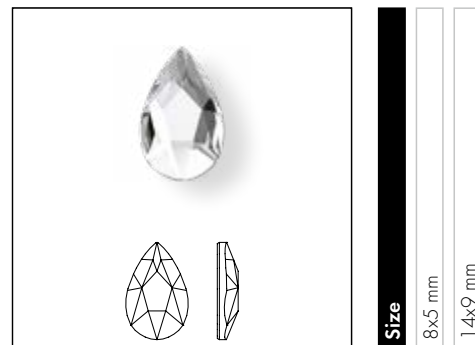

Crystal		
<input type="checkbox"/>	Crystal F (001)	<input type="checkbox"/>
Colors		
Plain Colors		
<input type="checkbox"/>	Aquamarine F (202)	<input type="checkbox"/>
<input type="checkbox"/>	Emerald F (205)	<input type="checkbox"/>
<input type="checkbox"/>	Graphite F (253)	<input type="checkbox"/>
<input type="checkbox"/>	Jet (280)	<input type="checkbox"/>
<input type="checkbox"/>	Sapphire F (206)	<input type="checkbox"/>
<input type="checkbox"/>	Scarlet F (276)	<input type="checkbox"/>
<input type="checkbox"/>	Vintage Rose F (319)	<input type="checkbox"/>
Crystal Effects		
Transparent Effects		
<input type="checkbox"/>	Crystal Aurore Boreale F (001 AB)	<input type="checkbox"/>
<input type="checkbox"/>	Crystal Golden Shadow F (001 GSHA)	<input type="checkbox"/>
<input type="checkbox"/>	Crystal Heliotrope F (001 HEL)	<input type="checkbox"/>
<input type="checkbox"/>	Crystal Shimmer F (001 SHIM)	<input type="checkbox"/>
Color Effects		
Transparent Effects		
<input type="checkbox"/>	Vintage Rose Shimmer F (319 SHIM)	<input type="checkbox"/>

2304 Raindrop Flat Back

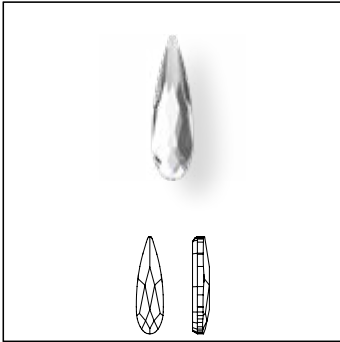

Size	6x1.7 mm	10x2.8 mm	14x3.9 mm
------	----------	-----------	-----------

Crystal	6x1.7 mm	10x2.8 mm	14x3.9 mm
Crystal F (001)	■	■	■
Colors			
Plain Colors			
Light Siam F (227)	■	■	■
Crystal Effects			
Transparent Effects			
Crystal Aurore Boreale F (001 AB)	■	■	■
Crystal Golden Shadow F (001 GSHA)	■	■	■
Crystal Heliotrope F (001 HEL)	■	■	■
Crystal Shimmer F (001 SHIM)	■	■	■

2400 Square Flat Back

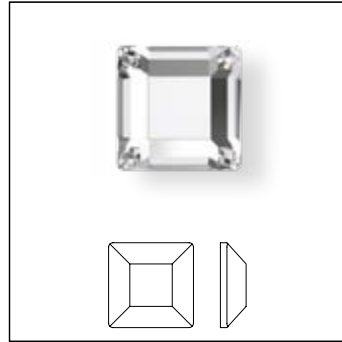

Size	2.2 mm	3 mm	4 mm	6 mm
------	--------	------	------	------

Crystal	2.2 mm	3 mm	4 mm	6 mm
Crystal F (001)	■	■	■	■
Colors				
Plain Colors				
Amethyst F (204)		■	■	
Aquamarine F (202)		■	■	
Black Diamond F (215)		■	■	
Emerald F (205)		■	■	
Jet (280)		■	■	■
Light Colorado Topaz F (246)		■	■	■
Light Rose F (223)		■	■	
Scarlet F (276)		■	■	
ReCreated™ Colors				
ReCreated™ Dark Jonquil F (1407)		■	■	
ReCreated™ Light Smoked Topaz F (1402)		■	■	
ReCreated™ Peridot F (1408)		■	■	
ReCreated™ Smoked Topaz F (1403)		■	■	
TCF™ Colors				
Dark Orange F (1202 TCF™)		■	■	
Crystal Effects				
Transparent Effects				
Crystal Aurore Boreale F (001 AB)		■	■	■
Crystal Golden Shadow F (001 GSHA)		■	■	■
Crystal Heliotrope F (001 HEL)		■	■	
Crystal Shimmer F (001 SHIM)		■	■	
Crystal Silver Night (001 SINI)		■	■	
Metallic Effects				
Crystal Aurum F (001 AUR)		■	■	

2471 Cushion Flat Back

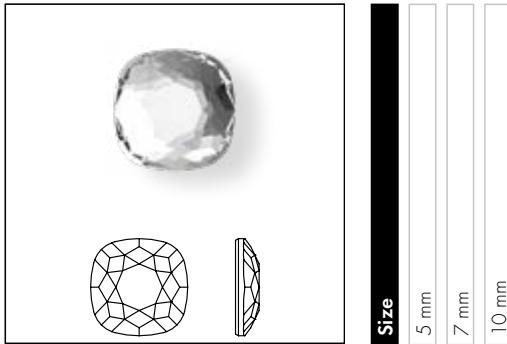

Size
5 mm
7 mm
10 mm

Crystal

Crystal F (001)

Colors

Plain Colors

Aquamarine F (202)

Emerald F (205)

Graphite F (253)

Jet (280)

Sapphire F (206)

Scarlet F (276)

Vintage Rose F (319)

Crystal Effects

Transparent Effects

Crystal Aurore Boreale F (001 AB)

Crystal Golden Shadow F (001 GSHA)

Color Effects

Transparent Effects

Vintage Rose Shimmer F (319 SHIM)

2472 Trilliant Flat Back

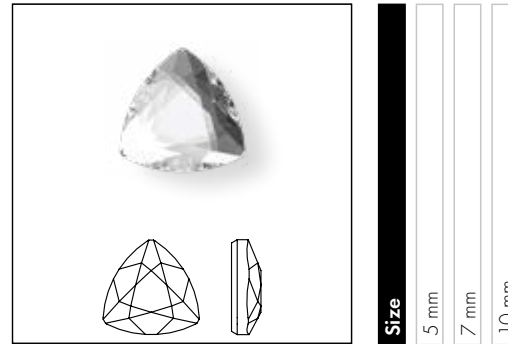

Size
5 mm
7 mm
10 mm

Crystal

Crystal F (001)

Colors

Plain Colors

Aquamarine F (202)

Emerald F (205)

Graphite F (253)

Jet (280)

Sapphire F (206)

Scarlet F (276)

Vintage Rose F (319)

Crystal Effects

Transparent Effects

Crystal Aurore Boreale F (001 AB)

Crystal Golden Shadow F (001 GSHA)

2483 Classic Square Flat Back

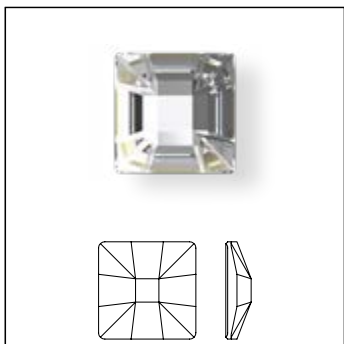

Size
10 mm
25 mm

Crystal

Crystal F (001)

Crystal Effects

Metallic Effects

Crystal Comet Argent Light SI (001 CASI)

Crystal Comet Argent Light V SI (001 CAVSI)

2493 Chessboard Flat Back

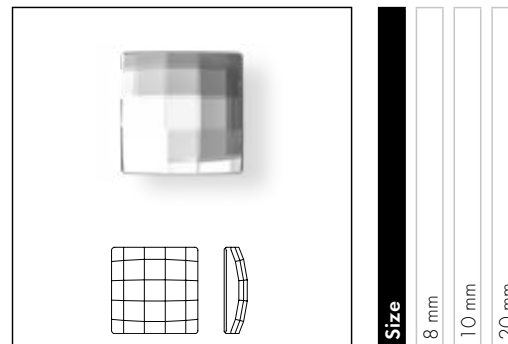

Size
8 mm
10 mm
20 mm

Crystal

Crystal F (001)

Crystal Effects

Transparent Effects

Crystal Aurore Boreale F (001 AB)

2510 Baguette Flat Back

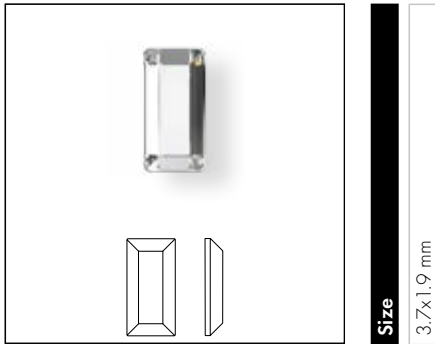

- Crystal**
- Crystal F (001)
- Colors**
- Plain Colors**
- Aquamarine F (202)
- Black Diamond F (215)
- Emerald F (205)
- Jet (280)
- Light Colorado Topaz F (246)
- ReCreated™ Colors**
- ReCreated™ Dark Jonquil F (1407)
- ReCreated™ Light Smoked Topaz F (1402)
- ReCreated™ Peridot F (1408)
- ReCreated™ Smoked Topaz F (1403)
- TCF™ Colors**
- Dark Orange F (1202 TCF™)
- Crystal Effects**
- Transparent Effects**
- Crystal Aurore Boreale F (001 AB)
- Crystal Golden Shadow F (001 GSHA)
- Crystal Heliotrope F (001 HEL)
- Crystal Shimmer F (001 SHIM)
- Metallic Effects**
- Crystal Aurum F (001 AUR)

2520 Cosmic Flat Back

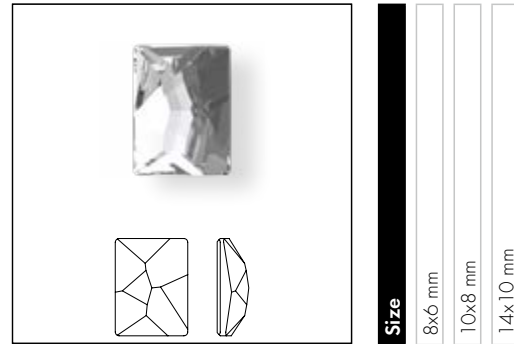

- Crystal**
- Crystal F (001)
- Colors**
- Plain Colors**
- Jet (280)
- Crystal Effects**
- Transparent Effects**
- Crystal Aurore Boreale F (001 AB)
- Crystal Golden Shadow F (001 GSHA)

2555 Cosmic Baguette Flat Back

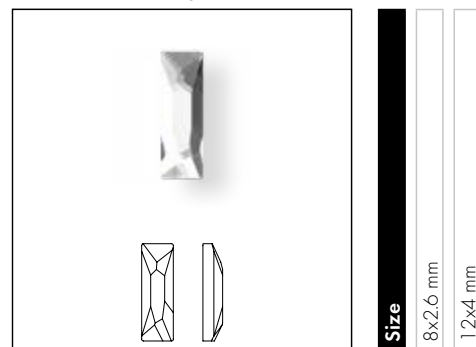

- Crystal**
- Crystal F (001)
- Crystal Effects**
- Transparent Effects**
- Crystal Aurore Boreale F (001 AB)
- Crystal Golden Shadow F (001 GSHA)

2602 Emerald Cut Flat Back

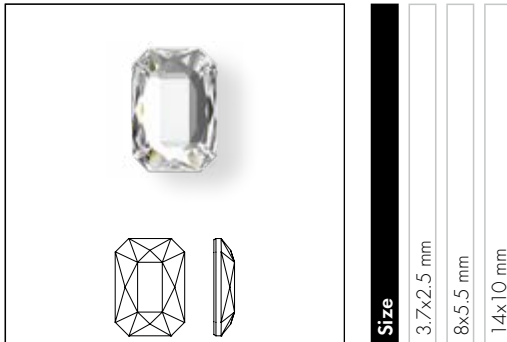

Size

3.7x2.5 mm

8x5.5 mm

14x10 mm

Crystal

Crystal F (001)

Colors

Plain Colors

Aquamarine F (202)

Emerald F (205)

Graphite F (253)

Jet (280)

Sapphire F (206)

Scarlet F (276)

Vintage Rose F (319)

Crystal Effects

Transparent Effects

Crystal Aurore Boreale F (001 AB)

Crystal Golden Shadow F (001 GSHA)

Crystal Heliotrope F (001 HEL)

Crystal Shimmer F (001 SHIM)

Color Effects

Transparent Effects

Vintage Rose Shimmer F (319 SHIM)

2603 Oval Flat Back

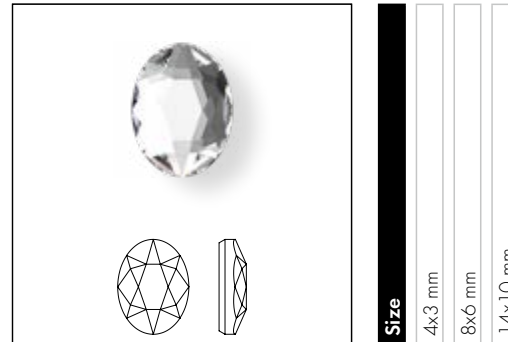

Size

4x3 mm

8x6 mm

14x10 mm

Crystal

Crystal F (001)

Colors

Plain Colors

Aquamarine F (202)

Emerald F (205)

Graphite F (253)

Jet (280)

Sapphire F (206)

Scarlet F (276)

Vintage Rose F (319)

Crystal Effects

Transparent Effects

Crystal Aurore Boreale F (001 AB)

Crystal Golden Shadow F (001 GSHA)

2709 Rhombus Flat Back

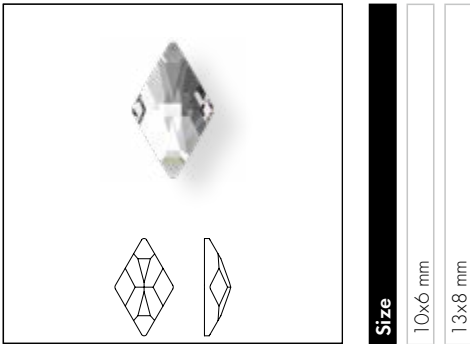

- Crystal**
- Crystal F (001)
- Colors**
- Plain Colors**
- Aquamarine F (202)
- Black Diamond F (215)
- Light Rose F (223)
- Light Siam F (227)
- Crystal Effects**
- Transparent Effects**
- Crystal Aurore Boreale F (001 AB)
- Crystal Golden Shadow F (001 GSHA)
- Crystal Silver Shade F (001 SSHA)

2711 Triangle Flat Back

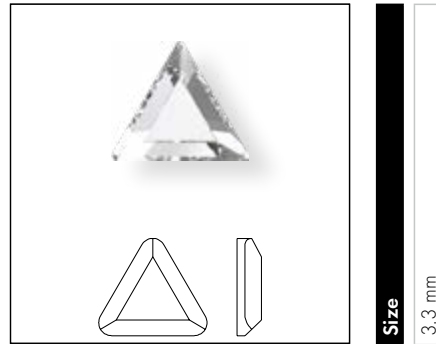

- Crystal**
- Crystal F (001)
- Crystal Effects**
- Transparent Effects**
- Crystal Aurore Boreale F (001 AB)
- Crystal Golden Shadow F (001 GSHA)

2715 Connector Flat Back

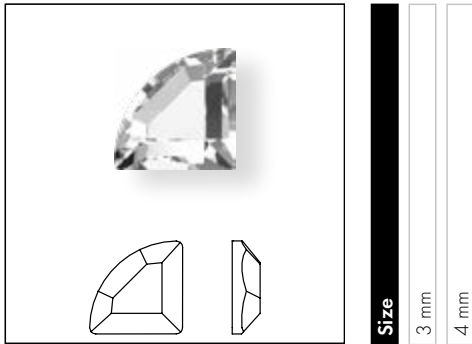

Size
3 mm
4 mm

Crystal

Crystal F (001)

Colors

Plain Colors

Amethyst F (204)

Aquamarine F (202)

Emerald F (205)

Jet (280)

Light Colorado Topaz F (246)

Scarlet F (276)

Crystal Effects

Transparent Effects

Crystal Aurore Boreale F (001 AB)

Crystal Golden Shadow F (001 GSHA)

Crystal Silver Night F (001 SINI)

2716 Rivoli Triangle Flat Back

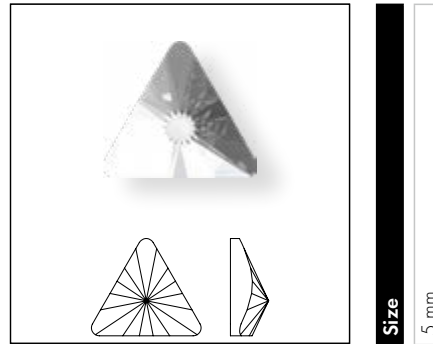

Size
5 mm

Crystal

Crystal F (001)

Crystal Effects

Transparent Effects

Crystal Aurore Boreale F (001 AB)

TRIANGLE FAMILY

2738 Triangle Alpha Flat Back

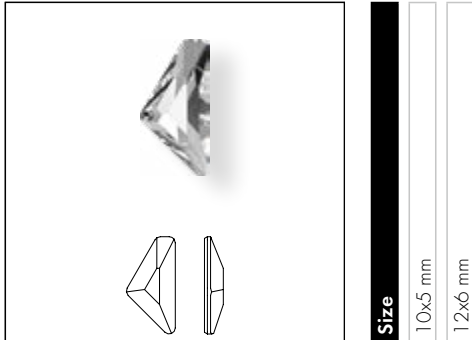

Size

10x5 mm

12x6 mm

Crystal

Crystal F (001)

Crystal Effects

Transparent Effects

Crystal Aurore Boreale F (001 AB)

Crystal Golden Shadow F (001 GSHA)

Crystal Silver Night (001 SINI)

2739 Triangle Beta Flat Back



Size

5.8x5.3 mm

7x6.5 mm

Crystal

Crystal F (001)

Crystal Effects

Transparent Effects

Crystal Aurore Boreale F (001 AB)

Crystal Golden Shadow (001 GSHA)

Crystal Silver Night (001 SINI)

2740 Triangle Gamma Flat Back

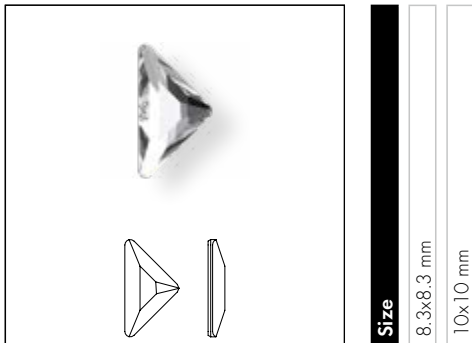

Size

8.3x8.3 mm

10x10 mm

Crystal

Crystal F (001)

Crystal Effects

Transparent Effects

Crystal Aurore Boreale F (001 AB)

Crystal Golden Shadow F (001 GSHA)

Crystal Silver Night (001 SINI)

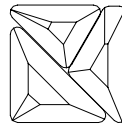

When Alpha, Beta, and Gamma Flat Backs are arranged together, they form a square.

2754 Star Flower Flat Back NoHF

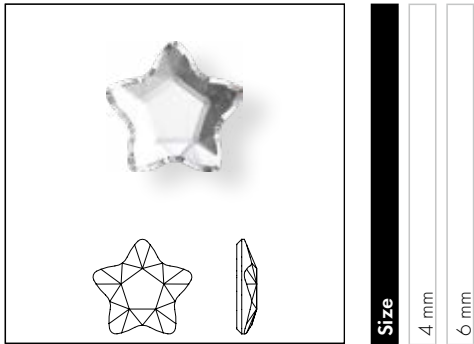

Size
4 mm
6 mm

Crystal

Crystal F (001)

Colors

Plain Colors

Amethyst F (204)

Aquamarine F (202)

Iris F (219)

Jet (280)

Light Rose F (223)

Light Topaz F (226)

Rose F (209)

Scarlet F (276)

ReCreated™ Colors

ReCreated™ Peridot F (1408)

TCF™ Colors

Dark Rose F (1201 TCF™)

Crystal Effects

Transparent Effects

Crystal Aurore Boreale F (001 AB)

Crystal Golden Shadow F (001 GSHA)

2770 Wing Flat Back

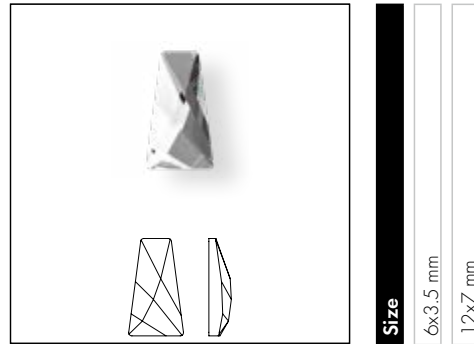

Size
6x3.5 mm
12x7 mm

Crystal

Crystal F (001)

Colors

Plain Colors

Black Diamond F (215)

Crystal Effects

Transparent Effects

Crystal Golden Shadow F (001 GSHA)

GEOMETRIC FLAT BACKS

2771 Kite Flat Back

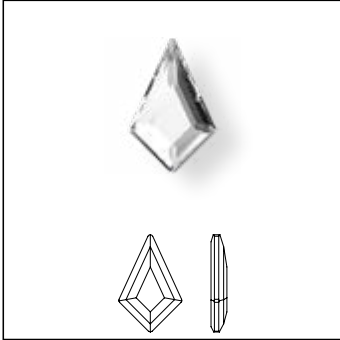

Size			
	6.4x4.2 mm	8.6x5.6 mm	12.9x8.3 mm

Crystal			
Crystal F (001)	■	■	■
Colors			
Plain Colors			
Aquamarine F (202)	■	■	■
Black Diamond F (215)	■	■	■
Jet (280)	■	■	■
Light Rose F (223)	■	■	■
Light Siam F (227)	■	■	■
Crystal Effects			
Transparent Effects			
Crystal Aurore Boreale F (001 AB)	■	■	■
Crystal Golden Shadow F (001 GSHA)	■	■	■
Crystal Shimmer F (001 SHIM)	■	■	■
Crystal Silver Shade F (001 SSHA)	■	■	■
Color Effects			
Metallic Effects			
Jet Hematite (280 HEM)	■	■	■

2772 Trapeze Flat Back

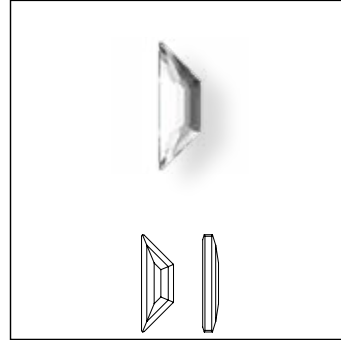

Size			
	6.5x2.1 mm	8.6x2.8 mm	12.9x4.2 mm

Crystal			
Crystal F (001)	■	■	■
Colors			
Plain Colors			
Aquamarine F (202)	■	■	■
Black Diamond F (215)	■	■	■
Jet (280)	■	■	■
Crystal Effects			
Transparent Effects			
Crystal Aurore Boreale F (001 AB)	■	■	■
Crystal Golden Shadow F (001 GSHA)	■	■	■
Crystal Silver Shade F (001 SSHA)	■	■	■
Color Effects			
Metallic Effects			
Jet Hematite (280 HEM)	■	■	■

2773 Diamond Shape Flat Back

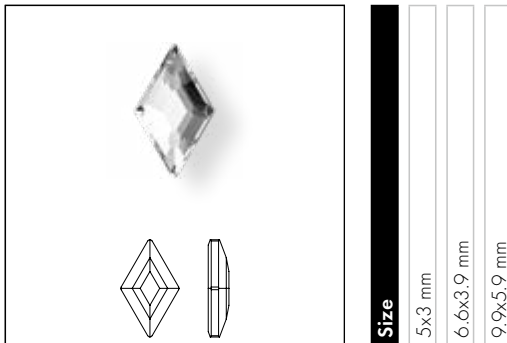

Size

- 5x3 mm
- 6.6x3.9 mm
- 9.9x5.9 mm

Crystal

Crystal F (001)

Colors

Plain Colors

Aquamarine F (202)

Black Diamond F (215)

Jet (280)

Light Rose F (223)

Light Siam F (227)

Crystal Effects

Transparent Effects

Crystal Aurore Boreale F (001 AB)

Crystal Golden Shadow F (001 GSHA)

Crystal Shimmer F (001 SHIM)

Crystal Silver Shade F (001 SSHA)

Color Effects

Metallic Effects

Jet Hematite (280 HEM)

2774 Elongated Pentagon Flat Back

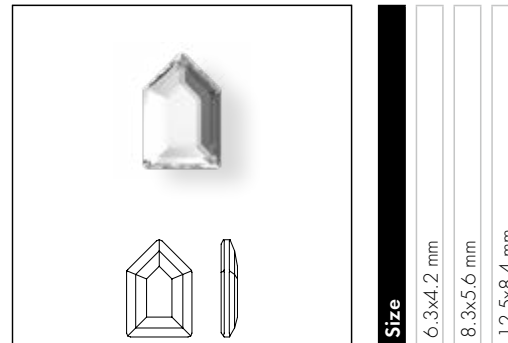

Size

- 6.3x4.2 mm
- 8.3x5.6 mm
- 12.5x8.4 mm

Crystal

Crystal F (001)

Colors

Plain Colors

Aquamarine F (202)

Black Diamond F (215)

Jet (280)

Light Siam F (227)

Crystal Effects

Transparent Effects

Crystal Aurore Boreale F (001 AB)

Crystal Silver Shade F (001 SSHA)

Color Effects

Metallic Effects

Jet Hematite (280 HEM)

2775 Concise Pentagon Flat Back

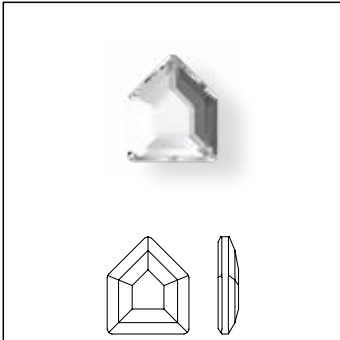

Size
5x4.2 mm
6.7x5.6 mm
10x8.4 mm

Crystal	Crystal F (001)		
Colors			
Plain Colors			
Aquamarine F (202)			
Black Diamond F (215)			
Jet (280)			
Light Siam F (227)			
Crystal Effects			
Transparent Effects			
Crystal Aurore Boreale F (001 AB)			
Crystal Silver Shade F (001 SSHA)			
Color Effects			
Metallic Effects			
Jet Hematite (280 HEM)			

2776 Elongated Hexagon Flat Back

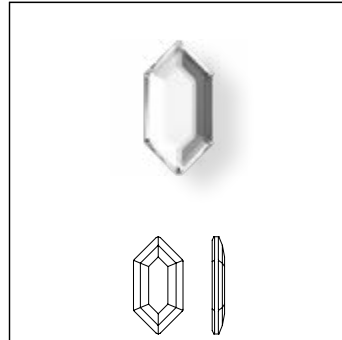

Size
8.2x4.2 mm
11x5.6 mm
16.5x8.4 mm

Crystal	Crystal F (001)		
Colors			
Plain Colors			
Aquamarine F (202)			
Black Diamond F (215)			
Jet (280)			
Light Siam F (227)			
Crystal Effects			
Transparent Effects			
Crystal Aurore Boreale F (001 AB)			
Crystal Silver Shade F (001 SSHA)			
Color Effects			
Metallic Effects			
Jet Hematite (280 HEM)			

2777 Concise Hexagon Flat Back

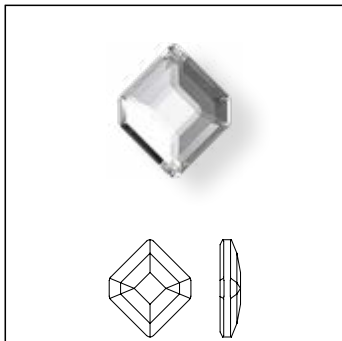

Size
5x4.2 mm
6.7x5.6 mm
10x8.4 mm

Crystal

Crystal F (001)

Colors

Plain Colors

Aquamarine F (202)

Black Diamond F (215)

Jet (280)

Light Siam F (227)

Crystal Effects

Transparent Effects

Crystal Aurore Boreale F (001 AB)

Crystal Silver Shade F (001 SSHA)

Color Effects

Metallic Effects

Jet Hematite (280 HEM)

Crystal F (001)	■	■	■
Aquamarine F (202)	■	■	
Black Diamond F (215)	■	■	■
Jet (280)	■	■	
Light Siam F (227)	■	■	■
Crystal Aurore Boreale F (001 AB)	■	■	■
Crystal Silver Shade F (001 SSHA)	■	■	
Jet Hematite (280 HEM)	■	■	■

2808 Heart Flat Back

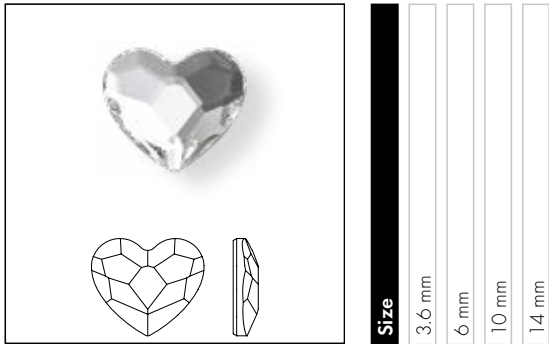

Crystal	3.6 mm	6 mm	10 mm	14 mm
Crystal F (001)	■	■	■	■
Colors				
Plain Colors				
Denim Blue F (266)		■	■	
Fuchsia F (502)		■	■	
Light Siam F (227)		■	■	
TCF™ Colors				
Dark Rose F (1201 TCF™)		■	■	■
Crystal Effects				
Transparent Effects				
Crystal Aurore Boreale F (001 AB)		■	■	■
Crystal Golden Shadow F (001 GSHA)		■	■	■

2813 Moon Flat Back

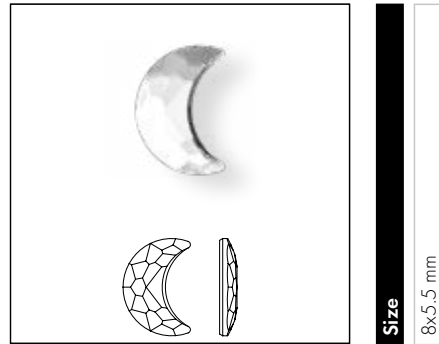

Crystal	8x5.5 mm
Crystal F (001)	■
Crystal Effects	
Transparent Effects	
Crystal Aurore Boreale F (001 AB)	■

2816 Rivoli Star Flat Back

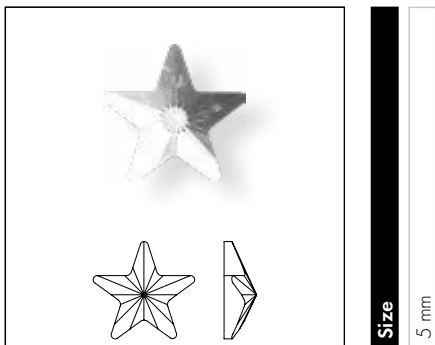

Crystal	5 mm
Crystal F (001)	■
Crystal Effects	
Transparent Effects	
Crystal Aurore Boreale F (001 AB)	■

2854 Butterfly Flat Back

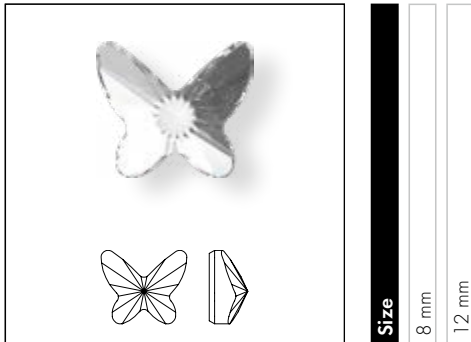

Size
8 mm
12 mm

Crystal

Crystal F (001)

Colors

Plain Colors

Amethyst F (204)

Denim Blue F (266)

Light Rose F (223)

Crystal Effects

Transparent Effects

Crystal Aurore Boreale F (001 AB)

2856 Skull Flat Back

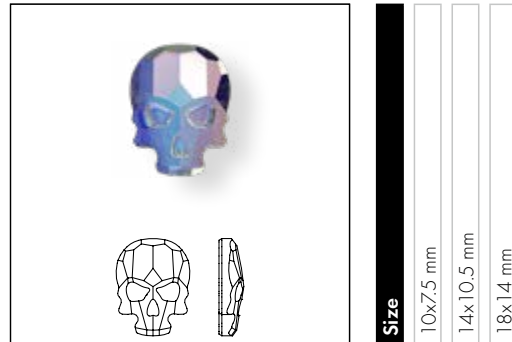

Size
10x7.5 mm
14x10.5 mm
18x14 mm

Colors

Plain Colors

Jet (280)

Crystal Effects

Transparent Effects

Crystal Aurore Boreale F (001 AB)

Crystal Silver Night (001 SINI)

Color Effects

Metallic Effects

Jet Hematite (280 HEM)

Product Details

Article Size	Packing Unit = Minimum Order Quantity in Pieces	Average Net Weight in Gram per Packing Unit Crystal (001)	Average Gross Weight in Gram per Packing Unit Crystal (001)
1098			
PP 24 (SS 12)	1440	20.96	31.16
PP 31 (SS 16)	1440	41.13	51.33
SS 20	720	36.58	46.78
SS 24	720	56.14	66.34
SS 29	288	34.19	51.37
SS 34	144	28.66	45.84
SS 39	144	39.51	56.69
2000			
SS 3	1,440	1.8	12.7
SS 4	1,440	3.3	13.7
2019			
4 mm	144	10.8	32.1
5 mm	72	10.2	29.5
6 mm	72	17.4	35.0
2035			
6 mm	360	27.1	34.8
10 mm	192	56.2	88.0
14 mm	96	88.4	109.0
20 mm	40	82.0	121.4
30 mm	12	95.4	130.8
40 mm	6	105.3	140.3
2058			
SS 5	1,440	4.4	17.9
SS 6	1,440	5.7	17.6
SS 7	1,440	7.1	19.0
SS 8	1,440	10.1	19.6
SS 9	1,440	12.4	22.0
SS 10	1,440	15.8	25.3
2088			
SS 12	1,440	22.1	30.3
SS 14	1,440	30.1	38.3
SS 16	1,440	39.9	49.8
SS 20	1,440	72.2	80.9
SS 24	1,440	127.12	136.3
SS 30	288	34.6	63.0
SS 34	144	25.9	48.6
SS 40	144	50.0	75.1
SS 48	96	76.1	101.3
2100			
SS 12	1,440	22.1	32.3
SS 16	1,440	34.1	44.3
SS 20	1,440	67.5	77.7
SS 30	288	33.5	56.7
SS 34	144	22.5	47.6
SS 40	144	34.0	59.1
SS 48	96	47.1	70.9
2200			
4x2 mm	720	6.5	18.5
8x4 mm	720	49.6	60.2

Article Size	Packing Unit = Minimum Order Quantity in Pieces	Average Net Weight in Gram per Packing Unit Crystal (001)	Average Gross Weight in Gram per Packing Unit Crystal (001)
2201			
4x1.8 mm	720	5.7	15.9
8x3.5 mm	144	10.03	31.11
14x6 mm	72	21.67	45.27
2205			
7.5 mm	288	20.3	30.5
10 mm	144	17.6	42.4
14 mm	72	22.3	45.9
2300			
8x4.8 mm	720	83.9	94.5
10x6 mm	360	56.9	67.8
2303			
8x5 mm	144	15.70	39.60
14x9 mm	72	36.65	60.25
2304			
10x2.8 mm	180	10.3	20.5
14x3.9 mm	96	13.1	36.3
6x1.7 mm	360	7.5	16.2
2400			
2.2 mm	1,440	11.3	21.7
3 mm	1,440	25.3	36.8
4 mm	720	30.0	41.0
6 mm	144	21.6	32.5
2471			
5 mm	288	17.3	25.6
7 mm	72	11.9	35.1
10 mm	72	30.2	51.6
2472			
5 mm	288	17.4	27.6
7 mm	144	20.8	42.8
10 mm	96	34.5	56.5
2483			
10 mm	144	90.3	120.2
25 mm	32	233.3	261.5
2493			
8 mm	216	72.3	91.8
10 mm	144	84.4	106.1
20 mm	24	108.5	137.9
2510			
3.7x1.9 mm	720	8.2	10.6
2520			
8x6 mm	288	50.8	80.2
10x8 mm	144	72.3	90.4
14x10 mm	144	119.3	140.8
2555			
8x2.6 mm	240	18.4	27.5
12x4 mm	144	28.8	33.6

Article Size	Packing Unit = Minimum Order Quantity in Pieces	Average Net Weight in Gram per Packing Unit Crystal (001)	Average Gross Weight in Gram per Packing Unit Crystal (001)
2602			
3.7x2.5 mm	720	11.5	21.7
8x5.5 mm	144	17.89	41.79
14x10 mm	72	58.61	82.21
2603			
4x3 mm	288	6.8	17.0
8x6 mm	144	21.7	43.7
14x10 mm	72	50.3	72.3
2709			
10x6 mm	288	48.2	73.6
13x8 mm	144	41.0	60.1
2711			
3.3 mm	720	10.2	16.4
2715			
3 mm	288	4.0	14.2
4 mm	288	8.2	18.4
2716			
5 mm	720	35.8	75.1
2739			
5.8x5.3 mm	216	19.2	41.9
7x6.5 mm	144	22.6	39.8
2740			
8.3x8.3 mm	216	35.1	54.2
10x10 mm	96	25.1	41.1
2754			
4 mm	720	13.6	23.8
6 mm	360	20.5	30.7
2770			
6x3.5 mm	1,440	60.3	70.3
12x7 mm	192	49.8	98.4
2771			
6.4x4.2 mm	288	9.04	17.87
8.6x5.6 mm	216	16.84	43.02
12.9x8.3 mm	144	36.29	61.39
2772			
6.5x2.1 mm	288	6.39	15.17
8.6x2.8 mm	288	16.29	40.71
12.9x4.2 mm	144	25.57	53.86
2773			
5x3 mm	288	4.83	13.66
6.6x3.9 mm	288	11.23	35.65
9.9x5.9 mm	144	19.30	43.39
2774			
6.3x4.2 mm	288	18.7	29.6
8.3x5.6 mm	144	19.5	39.4
12.5x8.4 mm	96	39.0	60.3

Article Size	Packing Unit = Minimum Order Quantity in Pieces	Average Net Weight in Gram per Packing Unit Crystal (001)	Average Gross Weight in Gram per Packing Unit Crystal (001)
2775			
5x4.2 mm	288	13.9	24.7
6.7x5.6 mm	144	15.0	34.3
10x8.4 mm	144	43.6	66.4
2776			
8.2x4.2 mm	144	11.2	30.1
11x5.6 mm	72	11.3	28.8
16.5x8.4 mm	72	35.6	55.8
2777			
5x4.2 mm	288	10.4	21.3
6.7x5.6 mm	144	10.5	29.7
10x8.4 mm	144	32.8	52.7
2808			
3.6 mm	720	18.4	20.8
6 mm	288	19.8	28.9
10 mm	144	38.8	55.9
14 mm	96	56.4	86.8
2813			
8x5.5 mm	144	13.1	37.7
2816			
5 mm	720	23.6	30.7
2854			
8 mm	216	36.0	52.2
12 mm	144	84.4	103.8
2856			
10x7.5 mm	72	20.2	38.6
14x10.5 mm	36	30.2	50.3
18x14 mm	30	53.0	83.4



Flat Backs Hotfix

03

Featuring a flat reverse side, Flat Backs Hotfix are pre-coated with a heat sensitive glue making them easy to apply to a large range of textiles. Highly versatile and incredibly flexible, they create designs that shimmer with lasting durability.





















The captivating beauty of the Flat Back XILION and XIRIUS Rose is crafted through the use of a unique silver mirror coating on the reverse, amplifying light reflection and creating a warm, luminous appearance.





















Delivering brilliance through exquisite craftsmanship, the XIRIUS Star Rose 2100 joined our coveted XIRIUS Flat Back cuts in February 2025. Embodying Swarovski's dedication to unmatched precision and purity, it elevates modern aesthetics with sartorial elegance and symbolic depth. Merging timeless beauty with functional sophistication, the celestial-inspired cut transforms any design into a statement of contemporary elegance.

Swarovski's outstanding quality is underlined by the highest precision in table size and diameter to ensure brilliance is never compromised.

Colors & Effects







Colors

-  Crystal 001
-  Crystal Hotfix Transparent 001 HFT
-  White Opal 234
-  Light Silk 261
-  Silk 391
-  Light Peach 362
-  Vintage Rose 319
-  Blush Rose 257
-  Light Rose 223
-  Rose Peach 262
-  Padparadscha 542
-  Indian Pink 289
-  Rose 209
-  Fuchsia 502
-  Light Siam 227
-  Scarlet 276
-  Indian Siam 327
-  Siam 208
-  Ruby 501
-  Burgundy 515
-  Amethyst 204

-  Iris 219
-  Light Amethyst 212
-  Provence Lavender 283
-  Tanzanite 539
-  Purple Velvet 277
-  Aquamarine 202
-  Light Sapphire 211
-  Sapphire 206
-  Capri Blue 243
-  Majestic Blue 296
-  Cobalt 369
-  Dark Indigo 288
-  Montana 207
-  Denim Blue 266
-  Indicolite 379
-  Light Turquoise 263
-  Blue Zircon 229
-  Erinite 360
-  Chrysolite 238
-  Citrus Green 337
-  Fern Green 291

-  Majestic Green 336
-  Emerald 205
-  Jonquil 213
-  Light Topaz 226
-  Light Colorado Topaz 246
-  Topaz 203
-  Greige 284
-  Black Diamond 215
-  Graphite 253
-  Jet 280



















Swarovski ReCreated™ Colors

-  ReCreated™ Ice Blue 1405
-  ReCreated™ Dark Sapphire 1404
-  ReCreated™ Peridot 1408
-  ReCreated™ Dark Jonquil 1407
-  ReCreated™ Light Smoked Topaz 1402
-  ReCreated™ Smoked Topaz 1403

TCF™ Colors



















-  Dark Rose 1201 TCF™
-  Dark Orange 1202 TCF™

Effects







-  Crystal Moonlight
001 MOL
-  Crystal Transmission
Hotfix Transparent
001 TRA HFT
-  Crystal Shimmer
001 SHIM
-  Crystal Aurore Boreale
001 AB
-  Crystal Vitrail Light
001 VL
-  Crystal Paradise Shine
001 PARSH
-  Crystal Vitrail Medium
001 VM
-  Crystal Volcano
001 VOL
-  Crystal Heliotrope
001 HEL
-  Crystal Bermuda Blue
001 BBL
-  Crystal Blue Shade
001 BLSH
-  Crystal Golden Shadow
001 GSHA
-  Crystal Metallic Sunshine
001 METSH
-  Crystal Aurum
001 AUR
-  Crystal Rose Gold
001 ROGL
-  Crystal Light Chrome
001 LTCH
-  Crystal Silver Shade
001 SSHA
-  Crystal Silver Night
001 SINI
-  Jet Hematite
280 HEM

Crystal Lacquer^{PRO} Effects











Crystal Lacquer^{PRO} Ignite Effects

-  Crystal Linen Ignite
001 L164I
-  Crystal Soft Rose Ignite*
001 L167I
-  Crystal Flamingo Ignite
001 L162I
-  Crystal Dahlia Ignite
001 L177I
-  Crystal Orange Ignite
001 L159I
-  Crystal Maroon Ignite
001 L160I
-  Crystal Poppy Red Ignite
001 L179I
-  Crystal Orchid Ignite
001 L171I
-  Crystal Purple Ignite
001 L161I
-  Crystal Sky Ignite
001 L163I
-  Crystal Denim Ignite
001 L166I
-  Crystal Teal Ignite
001 L178I
-  Crystal Pine Green Ignite
001 L170I
-  Crystal Agave Ignite
001 L165I
-  Crystal Soft Mint Ignite
001 L168I
-  Crystal Soft Yellow Ignite
001 L169I
-  Crystal Mango Ignite
001 L152I
-  Crystal Dark Grey Ignite
001 L111I

Crystal Electric Lacquer^{PRO} Ignite Effects



-  Crystal Electric White Ignite
001 L139I
-  Crystal Electric Orange Ignite
001 L136I
-  Crystal Electric Pink Ignite
001 L137I
-  Crystal Electric Violet Ignite
001 L148I
-  Crystal Electric Blue Ignite
001 L134I
-  Crystal Electric Green Ignite
001 L135I
-  Crystal Electric Yellow Ignite
001 L138I

Shimmer Effects

-  Silk Shimmer
391 SHIM
-  Light Rose Shimmer
223 SHIM
-  Fuchsia Shimmer
502 SHIM
-  Light Siam Shimmer
227 SHIM
-  Tanzanite Shimmer
539 SHIM
-  Light Sapphire Shimmer
211 SHIM
-  Blue Zircon Shimmer
229 SHIM
-  ReCreated™ Peridot Shimmer*
1408 SHIM
-  Topaz Shimmer
203 SHIM
-  Black Diamond Shimmer
215 SHIM

*this color does not exist for 2078, but for other Flat Backs. For more details, please see the product matrix on the respective items.

AB Effects

-  Light Rose Aurore Boreale
223 AB
-  Light Siam Aurore Boreale
227 AB
-  Sapphire Aurore Boreale
206 AB
-  Jonquil Aurore Boreale
213 AB
-  Jet Aurore Boreale
280 AB

Nightfall Effects

-  Siam Nightfall
208 NIFA
-  Capri Blue Nightfall
243 NIFA
-  Emerald Nightfall
205 NIFA
-  Graphite Nightfall
253 NIFA

Cabochons

-  Crystal White Pearl
001 650
-  Crystal Nacre
001 191
-  Crystal Creampearl
001 291
-  Crystal Golden Shadow
001 GSHA
-  Crystal Rosaline Pearl
001 294
-  Crystal Dark Grey Pearl
001 617
-  Jet
280
-  Jet Hematite
280 HEM

Crystal Lacquer^{PRO} Ignite Effects

-  Crystal Linen Ignite
001 L164I
-  Crystal Flamingo Ignite
001 L162I
-  Crystal Agave Ignite
001 L165I
-  Crystal Soft Mint Ignite
001 L168I

Crystal Electric Lacquer^{PRO} Ignite Effects

-  Crystal Electric White Ignite
001 L139I
-  Crystal Electric Orange Ignite
001 L136I
-  Crystal Electric Pink Ignite
001 L137I
-  Crystal Electric Violet Ignite
001 L148I
-  Crystal Electric Blue Ignite
001 L134I
-  Crystal Electric Green Ignite
001 L135I
-  Crystal Electric Yellow Ignite
001 L138I

Rimmed Flat Backs

-  Jet Light Chrome Z
280 LTCHZ

Numerical Order

001	Crystal	001 SHIM	Crystal Shimmer	257	Blush Rose
001 191	Crystal Nacre	001 SINI	Crystal Silver Night	261	Light Silk
001 291	Crystal Creampearl	001 SSHA	Crystal Silver Shade	262	Rose Peach
001 294	Crystal Rosaline Pearl	001 TRA HFT	Crystal Transmission Hotfix Transparent	263	Light Turquoise
001 617	Crystal Dark Grey Pearl	001 VL	Crystal Vitrail Light	266	Denim Blue
001 650	Crystal White Pearl	001 VM	Crystal Vitrail Medium	276	Scarlet
001 AB	Crystal Aurore Boreale	001 VOL	Crystal Volcano	277	Purple Velvet
001 AUR	Crystal Aurum	202	Aquamarine	280 AB	Jet Aurore Boreale
001 BBL	Crystal Bermuda Blue	203 SHIM	Topaz Shimmer	280 HEM	Jet Hematite
001 BLSH	Crystal Blue Shade	203	Topaz	280 LTCHZ	Jet Light Chrome Z
001 GSHA	Crystal Golden Shadow	204	Amethyst	280	Jet
001 HEL	Crystal Heliotrope	205 NIFA	Emerald Nightfall	283	Provence Lavender
001 HFT	Crystal Hotfix Transparent	205	Emerald	284	Greige
001 L1111	Crystal Dark Grey Ignite	206 AB	Sapphire Aurore Boreale	288	Dark Indigo
001 L1341	Crystal Electric Blue Ignite	206	Sapphire	289	Indian Pink
001 L1351	Crystal Electric Green Ignite	207	Montana	291	Fern Green
001 L1361	Crystal Electric Orange Ignite	208 NIFA	Siam Nightfall	296	Majestic Blue
001 L1371	Crystal Electric Pink Ignite	208	Siam	319	Vintage Rose
001 L1381	Crystal Electric Yellow Ignite	209	Rose	327	Indian Siam
001 L1391	Crystal Electric White Ignite	211 SHIM	Light Sapphire Shimmer	336	Majestic Green
001 L1481	Crystal Electric Violet Ignite	211	Light Sapphire	337	Citrus Green
001 L1521	Crystal Mango Ignite	212	Light Amethyst	360	Erinite
001 L1591	Crystal Orange Ignite	213 AB	Jonquil Aurore Boreale	362	Light Peach
001 L1601	Crystal Maroon Ignite	213	Jonquil	369	Cobalt
001 L1611	Crystal Purple Ignite	215 SHIM	Black Diamond Shimmer	379	Indicolite
001 L1621	Crystal Flamingo Ignite	215	Black Diamond	391 SHIM	Silk Shimmer
001 L1631	Crystal Sky Ignite	219	Iris	391	Silk
001 L1641	Crystal Linen Ignite	223 AB	Light Rose Aurore Boreale	501	Ruby
001 L1651	Crystal Agave Ignite	223 SHIM	Light Rose Shimmer	502 SHIM	Fuchsia Shimmer
001 L1661	Crystal Denim Ignite	223	Light Rose	502	Fuchsia
001 L1671	Crystal Soft Rose Ignite	226	Light Topaz	515	Burgundy
001 L1681	Crystal Soft Mint Ignite	227 AB	Light Siam Aurore Boreale	539 SHIM	Tanzanite Shimmer
001 L1691	Crystal Soft Yellow Ignite	227 SHIM	Light Siam Shimmer	539	Tanzanite
001 L1701	Crystal Pine Green Ignite	227	Light Siam	542	Padparadscha
001 L1711	Crystal Orchid Ignite	229 SHIM	Blue Zircon Shimmer	1201 TCF™	Dark Rose
001 L1771	Crystal Dahlia Ignite	229	Blue Zircon	1202 TCF™	Dark Orange
001 L1781	Crystal Teal Ignite	234	White Opal	1402	ReCreated™ Light Smoked Topaz
001 L1791	Crystal Poppy Red Ignite	238	Chrysolite	1403	ReCreated™ Smoked Topaz
001 LTCH	Crystal Light Chrome	243 NIFA	Capri Blue Nightfall	1404	ReCreated™ Dark Sapphire
001 METSH	Crystal Metallic Sunshine	243	Capri Blue	1405	ReCreated™ Ice Blue
001 MOL	Crystal Moonlight	246	Light Colorado Topaz	1407	ReCreated™ Dark Jonquil
001 PARSH	Crystal Paradise Shine	253 NIFA	Graphite Nightfall	1408	ReCreated™ Peridot
001 ROGL	Crystal Rose Gold	253	Graphite	1408 SHIM	ReCreated™ Peridot Shimmer

Alphabetical Order

Amethyst (204)	Crystal Orchid Ignite (001 L1711)	Light Amethyst (212)
Aquamarine (202)	Crystal Paradise Shine (001 PARSH)	Light Colorado Topaz (246)
Black Diamond (215)	Crystal Pine Green Ignite (001 L1701)	Light Peach (362)
Black Diamond Shimmer (215 SHIM)	Crystal Poppy Red Ignite (001 L1791)	Light Rose (223)
Blue Zircon (229)	Crystal Purple Ignite (001 L1611)	Light Rose Aurore Boreale (223 AB)
Blue Zircon Shimmer (229 SHIM)	Crystal Rosaline Pearl (001 294)	Light Rose Shimmer (223 SHIM)
Blush Rose (257)	Crystal Rose Gold (001 ROGL)	Light Sapphire (211)
Burgundy (515)	Crystal Shimmer (001 SHIM)	Light Sapphire Shimmer (211 SHIM)
Capri Blue (243)	Crystal Silver Night (001 SINI)	Light Siam (227)
Capri Blue Nightfall (243 1051)	Crystal Silver Shade (001 SSHA)	Light Siam Aurore Boreale (227 AB)
Chrysolite (238)	Crystal Sky Ignite (001 L1631)	Light Siam Shimmer (227 SHIM)
Citrus Green (337)	Crystal Soft Mint Ignite (001 L1681)	Light Silk (261)
Cobalt (369)	Crystal Soft Rose Ignite (001 L1671)	Light Topaz (226)
Crystal (001)	Crystal Soft Yellow Ignite (001 L1691)	Light Turquoise (263)
Crystal Aurore Boreale (001 AB)	Crystal Teal Ignite (001 L1781)	Majestic Blue (296)
Crystal Aurum (001 AUR)	Crystal Transmission Hotfix Transparent (001 TRA HFT)	Majestic Green (336)
Crystal Agave Ignite (001 L1651)	Crystal Vitrail Light (001 VL)	Montana (207)
Crystal Bermuda Blue (001 BBL)	Crystal Vitrail Medium (001 VM)	Padparadscha (542)
Crystal Blue Shade (001 BLSH)	Crystal Volcano (001 VOL)	Provence Lavender (283)
Crystal Creamppearl (001 291)	Crystal White Pearl (001 650)	Purple Velvet (277)
Crystal Dahlia Ignite (001 L1771)	Dark Indigo (288)	ReCreated™ Dark Jonquil (1407)
Crystal Dark Grey Ignite (001 L1111)	Dark Orange (1202 TCF™)	ReCreated™ Dark Sapphire (1404)
Crystal Dark Grey Pearl (001 617)	Dark Rose (1201 TCF™)	ReCreated™ Ice Blue (1405)
Crystal Denim Ignite (001 L1661)	Denim Blue (266)	ReCreated™ Light Smoked Topaz (1402)
Crystal Electric Blue Ignite (001 L1341)	Emerald (205)	ReCreated™ Peridot (1408)
Crystal Electric Green Ignite (001 L1351)	Emerald Nightfall (205 NIFA)	ReCreated™ Peridot Shimmer (1408 SHIM)
Crystal Electric Pink Ignite (001 L1371)	Erinite (360)	ReCreated™ Smoked Topaz (1403)
Crystal Electric Violet Ignite (001 L1481)	Fern Green (291)	Rose (209)
Crystal Electric White Ignite (001 L1391)	Fuchsia (502)	Rose Peach (262)
Crystal Electric Yellow (001 L138S)	Fuchsia Shimmer (502 SHIM)	Ruby (501)
Crystal Electric Yellow Ignite (001 L1381)	Graphite (253)	Sapphire (206)
Crystal Flamingo Ignite (001 L1621)	Graphite Nightfall (253 NIFA)	Sapphire Aurore Boreale (206 AB)
Crystal Golden Shadow (001 GSHA)	Greige (284)	Scarlet (276)
Crystal Heliotrope (001 HEL)	Indian Pink (289)	Siam (208)
Crystal Hotfix Transparent (001 HFT)	Indian Siam (327)	Siam Nightfall (208 NIFA)
Crystal Light Chrome (001 LTCH)	Indicolite (379)	Silk (391)
Crystal Linen Ignite (001 L1641)	Iris (219)	Silk Shimmer (391 SHIM)
Crystal Mango Ignite (001 L1521)	Jet (280)	Tanzanite (539)
Crystal Maroon Ignite (001 L1601)	Jet Aurore Boreale (280 AB)	Tanzanite Shimmer (539 SHIM)
Crystal Metallic Sunshine (001 METSH)	Jet Hematite (280 HEM)	Topaz (203)
Crystal Moonlight (001 MOL)	Jet Light Chrome Z (280 LTCHZ)	Topaz Shimmer (203 SHIM)
Crystal Nacre (001 191)	Jonquil (213)	Vintage Rose (319)
Crystal Orange Ignite (001 L1591)	Jonquil Aurore Boreale (213 AB)	White Opal (234)

For details on available colors and effects for each article within the product groups, please see the product matrix of the respective item in the Collection 2026.











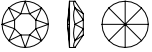















The plating resistance of effects is tested according to Swarovski's plating guidelines (SWAROVSKI.COM/S-PROFESSIONALS). Customers are advised to carry out their own tests if their plating parameters diverge from Swarovski plating guidelines.

Colors and effects can appear different when illuminated with different light sources. Swarovski uses standard light source D65 for color decision and comparison. Slight changes in shades are unavoidable. Colors may vary according to cut and foiling.

The composition of Advanced Crystal is compliant with regulatory industry norms and laws regarding the restriction or prohibition of certain substances in the most relevant segments of our customers. Please note that the compliance of the colors Light Siam and Siam varies according to certain industry regulations. Those regulations are indicated with * in the compliance overview. Indian Siam, Ruby and Scarlet (option to Lt. Siam) conform to all CLEAR-lists. For further information please visit swarovski.com/s-professionals

© 2026 D. Swarovski Distribution GmbH

Summary

1 2 3		1098 A HF PP 24 (SS 12), PP 31 (SS 16) SS 20, 24, 29, 34, 39	1 2		2300 M HF 8x4.8 mm	1 2		2602 M HF 3.7x2.5, 8x5.5, 14x10 mm
		2000 A HF SS 3			2303 M HF 8x5, 14x9 mm			2603 M HF 4x3, 8x6, 14x10 mm
		2038 A HF SS 5, 6, 8, 10			2304 M HF 10x2.8, 14x3.9 mm			2709 M HF 10x6 mm
		2038/1 A HF SS 10			2400 M HF 2.2, 3, 4, 6 mm			2711 M HF 3.3, 6 mm
		2078 A HF SS 12, 16, 20, 30, 34, 40, 48			2471 M HF 5, 7, 10 mm			2715 M HF 3, 4, 6 mm
		2078/1 A HF SS 16, 20			2472 M HF 5, 7, 10 mm			2738 M HF 10x5, 12x6 mm
		2080/4 HF SS 6, 10, 16, 20, 34			2510 M HF 3.7x1.9, 5x2.5 mm			2739 M HF 5.8x5.3, 7x6.5 mm
		2100 SS 12, 16, 20, 30, 34, 40, 48			2555 M HF 8x2.6, 12x4 mm			2740 M HF 8.3x8.3, 10x10 mm
		2200 M HF 4x2, 8x4 mm						
		2201 M HF 4x1.8, 8x3.5, 14x6 mm						
		2205 M HF 7.5, 10, 14 mm						

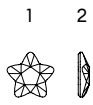

2754 M HF
4, 6 mm

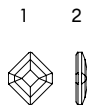

2777 M HF
5x4.2, 6.7x5.6,
10x8.4 mm



2770 M HF
6x3.5 mm



2788 M HF
8 mm



2771 M HF
6.4x4.2, 8.6x5.6,
12.9x8.3 mm



2808 M HF
3.6, 6, 10 mm



2772 M HF
6.5x2.1, 8.6x2.8,
12.9x4.2 mm



2813 M HF
8x5.5 mm



2773 M HF
5x3, 6.6x3.9,
9.9x5.9 mm



2816 M HF
5 mm

Summary



2774 M HF
6.3x4.2, 8.3x5.6,
12.5x8.4 mm



2775 M HF
5x4.2, 6.7x5.6,
10x8.4 mm



2776 M HF
8.2x4.2, 11x5.6,
16.5x8.4 mm

1098 XIRIUS Light

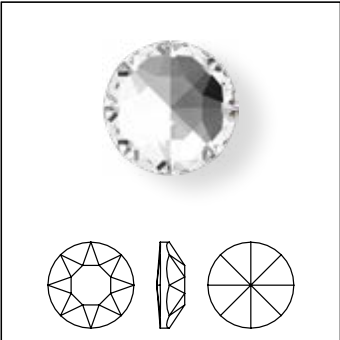

Size	PP 24	PP 31	SS 20
Crystal			
Crystal A HF (001)	■	■	■
Crystal Effects			
Transparent Effects			
Crystal Aurore Boreale A HF (001 AB)	■	■	■
Crystal Golden Shadow A HF (001 GSHA)	■	■	■
Crystal Silver Night A HF (001 SINI)	■	■	■
Crystal Silver Shade A HF (001 SSHA)	■	■	■

Crystal

Crystal A HF (001)

Crystal Effects

Transparent Effects

Crystal Aurore Boreale A HF (001 AB)

Crystal Golden Shadow A HF (001 GSHA)

Crystal Silver Night A HF (001 SINI)

Crystal Silver Shade A HF (001 SSHA)

2000 Rose

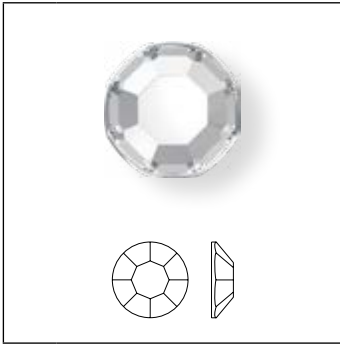

Size SS 3

2038 XILION Rose

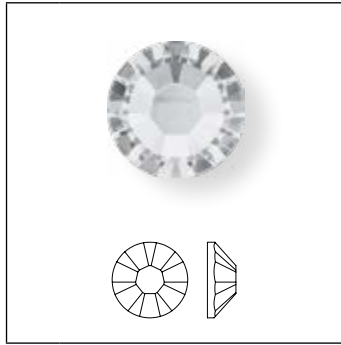

Size SS 5, 6, 8, 10

2078 XIRIUS Rose



Size SS 12, 16, 20, 30, 34, 40, 48

	2000		2038				2078						
	2000 Rose		2038 XILION Rose				2078 XIRIUS Rose						
	SS 3	SS 3	SS 5	SS 6	SS 8	SS 10	SS 12	SS 16	SS 20	SS 30	SS 34	SS 40	SS 48
Crystal													
Crystal Hotfix Transparent (001 HFT)	■		■	■	■	■	■	■	■	■	■	■	
Crystal A HF (001)	■		■	■	■	■	■	■	■	■	■	■	■
Colors													
Plain Colors													
Amethyst A HF (204)			■	■	■	■	■	■	■	■	■	■	■
Aquamarine A HF (202)			■	■	■	■	■	■	■	■	■	■	■
Black Diamond A HF (215)			■	■	■	■	■	■	■	■	■	■	■
Blue Zircon A HF (229)			■	■	■	■	■	■	■	■	■	■	■
Blush Rose A HF (257)			■	■	■	■	■	■	■	■	■	■	■
Burgundy A HF (515)			■	■	■	■	■	■	■	■	■	■	■
Capri Blue A HF (243)	■		■	■	■	■	■	■	■	■	■	■	■
Chrysolite A HF (238)			■	■	■	■	■	■	■	■	■	■	■
Citrus Green A HF (337)				■	■	■	■	■	■	■	■	■	■
Cobalt A HF (369)			■	■	■	■	■	■	■	■	■	■	■
Dark Indigo A HF (288)	■		■	■	■	■	■	■	■	■	■	■	■
Denim Blue A HF (266)			■	■	■	■	■	■	■	■	■	■	■
Emerald A HF (205)			■	■	■	■	■	■	■	■	■	■	■
Erinite A HF (360)			■	■	■	■	■	■	■	■	■	■	■
Fern Green A HF (291)	■		■	■	■	■	■	■	■	■	■	■	■
Fuchsia A HF (502)			■	■	■	■	■	■	■	■	■	■	■
Graphite A HF (253)			■	■	■	■	■	■	■	■	■	■	■
Greige A HF (284)			■	■	■	■	■	■	■	■	■	■	■
Indian Pink A HF (289)	■		■	■	■	■	■	■	■	■	■	■	■
Indian Siam A HF (327)	■		■	■	■	■	■	■	■	■	■	■	■

2000 2038 2078		Size	2000 Rose	2038 XILLION Rose	2078 XIRIUS Rose									
			SS 3	SS 5	SS 6	SS 8	SS 10	SS 12	SS 16	SS 20	SS 30	SS 34	SS 40	SS 48
Indicolite A HF (379)														
Iris A HF (219)														
Jet (280)														
Jet A HF (280)			■	■										■
Jonquil A HF (213)			■											
Light Amethyst A HF (212)														
Light Colorado Topaz A HF (246)			■											■
Light Peach A HF (362)			■											
Light Rose A HF (223)			■											
Light Sapphire A HF (211)			■											
Light Siam A HF (227)			■											
Light Silk A HF (261)														
Light Topaz A HF (226)														
Light Turquoise A HF (263)														
Majestic Blue A HF (296)														
Majestic Green A HF (336)														■
Montana A HF (207)			■											
Padparadscha A HF (542)														
Provence Lavender A HF (283)														
Purple Velvet A HF (277)														
Rose A HF (209)			■											■
Rose Peach A HF (262)			■											
Ruby A HF (501)														
Sapphire A HF (206)			■											■
Scarlet A HF (276)														
Siam A HF (208)														
Silk A HF (391)			■											■
Tanzanite A HF (539)			■											
Topaz A HF (203)														■
Vintage Rose A HF (319)			■											■
Opal Colors														
White Opal A HF (234)														
Swarovski ReCreated™ Colors														
ReCreated™ Dark Jonquil A HF (1407)														
ReCreated™ Dark Sapphire A HF (1404)			■											
ReCreated™ Ice Blue A HF (1405)														
ReCreated™ Light Smoked Topaz A HF (1402)			■											
ReCreated™ Peridot A HF (1408)			■											■
ReCreated™ Smoked Topaz A HF (1403)			■											

2000 2038 2078		Size	2000 Rose	2038 XILLION Rose	2078 XIRIUS Rose									
			SS 3	SS 5	SS 6	SS 8	SS 10	SS 12	SS 16	SS 20	SS 30	SS 34	SS 40	SS 48
TCF™ Colors														
	Dark Orange A HF (1202 TCF™)		■		■	■	■	■	■	■	■	■	■	
	Dark Rose A HF (1201 TCF™)		■		■	■	■	■	■	■	■	■	■	
Crystal Effects														
Transparent Effects														
	Crystal Aurore Boreale A HF (001 AB)		■	■	■	■	■	■	■	■	■	■	■	■
	Crystal Bermuda Blue A HF (001 BBL)				■	■	■	■	■	■	■	■	■	■
	Crystal Blue Shade A HF (001 BLSH)				■	■	■	■	■	■	■	■	■	■
	Crystal Golden Shadow A HF (001 GSHA)		■		■	■	■	■	■	■	■	■	■	■
	Crystal Heliotrope A HF (001 HEL)				■	■	■	■	■	■	■	■	■	■
	Crystal Moonlight A HF (001 MOL)		■		■	■	■	■	■	■	■	■	■	■
	Crystal Paradise Shine A HF (001 PARSH)		■		■	■	■	■	■	■	■	■	■	■
	Crystal Shimmer A HF (001 SHIM)		■		■	■	■	■	■	■	■	■	■	■
	Crystal Silver Night A HF (001 SINI)		■		■	■	■	■	■	■	■	■	■	■
	Crystal Silver Shade A HF (001 SSHA)		■		■	■	■	■	■	■	■	■	■	■
	Crystal Transmission HFT (001 TRA HFT)		■		■	■	■	■	■	■	■	■	■	■
	Crystal Vitrail Light A HF (001 VL)				■	■	■	■	■	■	■	■	■	■
	Crystal Vitrail Medium A HF (001 VM)				■	■	■	■	■	■	■	■	■	■
	Crystal Volcano A HF (001 VOL)				■	■	■	■	■	■	■	■	■	■
Metallic Effects														
	Crystal Aurum A HF (001 AUR)		■		■	■	■	■	■	■	■	■	■	■
	Crystal Light Chrome A HF (001 LTCH)		■		■	■	■	■	■	■	■	■	■	■
	Crystal Metallic Sunshine A HF (001 METSH)		■		■	■	■	■	■	■	■	■	■	■
	Crystal Rose Gold A HF (001 ROGL)		■		■	■	■	■	■	■	■	■	■	■
Crystal Lacquer^{PRO} Effects														
Crystal Lacquer^{PRO} Ignite Effects														
	Crystal Agave Ignite HFT (001 L1651)				■	■	■	■	■	■	■	■	■	■
	Crystal Dahlia Ignite HFT (001 L1771)				■	■	■	■	■	■	■	■	■	■
	Crystal Dark Grey Ignite HFT (001 L1111)				■	■	■	■	■	■	■	■	■	■
	Crystal Denim Ignite HFT (001 L1661)				■	■	■	■	■	■	■	■	■	■
	Crystal Flamingo Ignite HFT (001 L1621)				■	■	■	■	■	■	■	■	■	■
	Crystal Linen Ignite HFT (001 L1641)				■	■	■	■	■	■	■	■	■	■
	Crystal Mango Ignite HFT (001 L1521)				■	■	■	■	■	■	■	■	■	■
	Crystal Maroon Ignite HFT (001 L1601)				■	■	■	■	■	■	■	■	■	■
	Crystal Orange Ignite HFT (001 L1591)				■	■	■	■	■	■	■	■	■	■
	Crystal Orchid Ignite HFT (001 L1711)				■	■	■	■	■	■	■	■	■	■
	Crystal Pine Green Ignite HFT (001 L1701)				■	■	■	■	■	■	■	■	■	■
	Crystal Poppy Red Ignite HFT (001 L1791)				■	■	■	■	■	■	■	■	■	■
	Crystal Purple Ignite HFT (001 L1611)				■	■	■	■	■	■	■	■	■	■

2000 2038 2078		Size	2000 Rose	SS 3	2038 XILLION Rose	SS 5	SS 6	SS 8	SS 10	2078 XIRIUS Rose	SS 12	SS 16	SS 20	SS 30	SS 34	SS 40	SS 48
Crystal Sky Ignite HFT (001 L1631)																	
Crystal Soft Mint Ignite HFT (001 L1681)																	
Crystal Soft Rose Ignite HFT (001 L1671)																	
Crystal Soft Yellow Ignite HFT (001 L1691)																	
Crystal Teal Ignite HFT (001 L1781)																	
Crystal Electric Lacquer^{PRO} Ignite Effects																	
Crystal Electric Blue Ignite HFT (001 L1341)																	
Crystal Electric Green Ignite HFT (001 L1351)																	
Crystal Electric Orange Ignite HFT (001 L1361)																	
Crystal Electric Pink Ignite HFT (001 L1371)																	
Crystal Electric Violet Ignite HFT (001 L1481)																	
Crystal Electric White Ignite HFT (001 L1391)																	
Crystal Electric Yellow Ignite HFT (001 L1381)																	
Color Effects																	
Transparent Effects																	
Black Diamond Shimmer A HF (215 SHIM)																	
Blue Zircon Shimmer A HF (229 SHIM)																	
Capri Blue Nightfall A HF (243 NIFA)																	
Emerald Nightfall A HF (205 NIFA)																	
Fuchsia Shimmer A HF (502 SHIM)																	
Graphite Nightfall A HF (253 NIFA)																	
Jet AB A HF (280 AB)																	
Jonquil AB A HF (213 AB)																	
Light Rose AB A HF (223 AB)																	
Light Rose Shimmer A HF (223 SHIM)																	
Light Sapphire Shimmer A HF (211 SHIM)																	
Light Siam AB A HF (227 AB)																	
Light Siam Shimmer A HF (227 SHIM)																	
ReCreated™ Peridot Shimmer A HF (1408 SHIM)																	
Sapphire AB A HF (206 AB)																	
Siam Nightfall A HF (208 NIFA)																	
Silk Shimmer A HF (391 SHIM)																	
Tanzanite Shimmer A HF (539 SHIM)																	
Topaz Shimmer A HF (203 SHIM)																	
Metallic Effects																	
Jet Hematite A HF (280 HEM)																	

2038/I Rimmed Flat Back

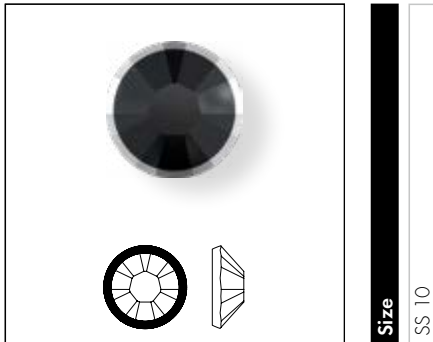

Size
SS 10

Color Effects

Metallic Effects

● Jet & Light Chrome Z A HF (280 LTCHZ)

2078/I Rimmed Flat Back

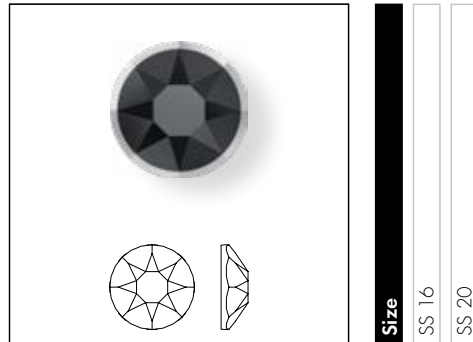

Size
SS 16
SS 20

Color Effects

Metallic Effects

● Jet & Light Chrome Z A HF (280 LTCHZ)

CABOCHON

2080/4 Cabochon



Size	SS 6	SS 10	SS 16	SS 20	SS 34
------	------	-------	-------	-------	-------

Colors

Plain Colors

Jet M HF (280)

Crystal Effects

Transparent Effects

Crystal Golden Shadow HF (001 GSHA)

Color Effects

Metallic Effects

Jet Hematite M HF (280 HEM)

Crystal Effects

Crystal Lacquer^{PRO} Effects

Crystal Lacquer^{PRO} Ignite Effects

Crystal Agave Ignite HFT (001 L1651)

Crystal Flamingo Ignite HFT (001 L1621)

Crystal Linen Ignite HFT (001 L1641)

Crystal Soft Mint Ignite HFT (001 L1681)

Crystal Electric Lacquer^{PRO} Ignite Effects

Crystal Electric Blue Ignite HFT (001 L1341)

Crystal Electric Green Ignite HFT (001 L1351)

Crystal Electric Orange Ignite HFT (001 L1361)

Crystal Electric Pink Ignite HFT (001 L1371)

Crystal Electric Violet Ignite HFT (001 L1481)

Crystal Electric White Ignite HFT (001 L1391)

Crystal Electric Yellow Ignite HFT (001 L1381)

Pearl Colors

Crystal Creampearl HF (001 CMPRL)

Crystal Dark Grey Pearl HF (001 DGREY)

Crystal Nacre HF (001 NACRE)

Crystal Rosaline Pearl HF (001 ROPRL)

Crystal White Pearl HF (001 WHITE)

Jet M HF (280)	■	■	■	■	■
Crystal Golden Shadow HF (001 GSHA)	■	■	■	■	■
Jet Hematite M HF (280 HEM)	■	■	■	■	■
Crystal Agave Ignite HFT (001 L1651)		■	■	■	■
Crystal Flamingo Ignite HFT (001 L1621)		■	■	■	■
Crystal Linen Ignite HFT (001 L1641)		■	■	■	■
Crystal Soft Mint Ignite HFT (001 L1681)		■	■	■	■
Crystal Electric Blue Ignite HFT (001 L1341)		■	■	■	■
Crystal Electric Green Ignite HFT (001 L1351)		■	■	■	■
Crystal Electric Orange Ignite HFT (001 L1361)		■	■	■	■
Crystal Electric Pink Ignite HFT (001 L1371)		■	■	■	■
Crystal Electric Violet Ignite HFT (001 L1481)		■	■	■	■
Crystal Electric White Ignite HFT (001 L1391)		■	■	■	■
Crystal Electric Yellow Ignite HFT (001 L1381)		■	■	■	■
Crystal Creampearl HF (001 CMPRL)	■	■	■	■	■
Crystal Dark Grey Pearl HF (001 DGREY)	■	■	■	■	■
Crystal Nacre HF (001 NACRE)	■	■	■	■	■
Crystal Rosaline Pearl HF (001 ROPRL)	■	■	■	■	■
Crystal White Pearl HF (001 WHITE)	■	■	■	■	■

2100 XIRIUS Star Rose



Size	SS 12	SS 16	SS 20	SS 30	SS 34	SS 40	SS 48
------	-------	-------	-------	-------	-------	-------	-------

Crystal

Crystal A HF (001)	■	■	■	■	■	■	■
--------------------	---	---	---	---	---	---	---

Colors

Plain Colors

Black Diamond A HF (215)	■	■	■	■	■	■	■
Graphite A HF (253)	■	■	■	■	■	■	■
Light Colorado Topaz A HF (246)	■	■	■	■	■	■	■
Light Rose A HF (223)	■	■	■	■	■	■	■
Light Siam A HF (227)	■	■	■	■	■	■	■
Light Silk A HF (261)	■	■	■	■	■	■	■
Majestic Green A HF (336)	■	■	■	■	■	■	■
Silk A HF (391)	■	■	■	■	■	■	■

ReCreated™ Colors

ReCreated™ Dark Jonquil A HF (1407)	■	■	■	■	■	■	■
ReCreated™ Dark Sapphire A HF (1404)	■	■	■	■	■	■	■
ReCreated™ Ice Blue A HF (1405)	■	■	■	■	■	■	■

TCF™ Colors

Dark Orange A HF (1202 TCF™)	■	■	■	■	■	■	■
Dark Rose A HF (1201 TCF™)	■	■	■	■	■	■	■

Crystal Effects

Transparent Effects

Crystal Aurore Boreale A HF (001 AB)	■	■	■	■	■	■	■
Crystal Blue Shade A HF (001 BLSH)	■	■	■	■	■	■	■
Crystal Golden Shadow A HF (001 GSHA)	■	■	■	■	■	■	■
Crystal Moonlight A HF (001 MOL)	■	■	■	■	■	■	■
Crystal Shimmer A HF (001 SHIM)	■	■	■	■	■	■	■
Crystal Silver Night A HF (001 SINI)	■	■	■	■	■	■	■
Crystal Silver Shade A HF (001 SSHA)	■	■	■	■	■	■	■

Metallic Effects

Crystal Light Chrome A HF (001 LTCH)	■	■	■	■	■	■	■
Crystal Metallic Sunshine A HF (001 METSH)	■	■	■	■	■	■	■

Color Effects

Metallic Effects

Jet Hematite A HF (280 HEM)	■	■	■	■	■	■	■
-----------------------------	---	---	---	---	---	---	---

2200 Navette Flat Back



Crystal	
Crystal M HF (001)	■ ■
Colors	
Plain Colors	
Aquamarine M HF (202)	■ ■
Black Diamond M HF (215)	■ ■
Emerald M HF (205)	■ ■
Jet M HF (280)	■ ■
Light Colorado Topaz M HF (246)	■ ■
Light Rose M HF (223)	■ ■
Scarlet M HF (276)	■ ■
ReCreated™ Colors	
ReCreated™ Dark Jonquil M HF (1407)	■ ■
ReCreated™ Light Smoked Topaz M HF (1402)	■ ■
ReCreated™ Peridot M HF (1408)	■ ■
ReCreated™ Smoked Topaz M HF (1403)	■ ■
TCF™ Colors	
Dark Orange M HF (1202 TCF™)	■ ■
Crystal Effects	
Transparent Effects	
Crystal Aurore Boreale M HF (001 AB)	■ ■
Crystal Golden Shadow M HF (001 GSHA)	■ ■
Crystal Heliotrope M HF (001 HEL)	■ ■
Crystal Shimmer M HF (001 SHIM)	■ ■
Crystal Silver Shade M HF (001 SSHA)	■ ■
Metallic Effects	
Crystal Aurum M HF (001 AUR)	■ ■

2201 Marquise Flat Back

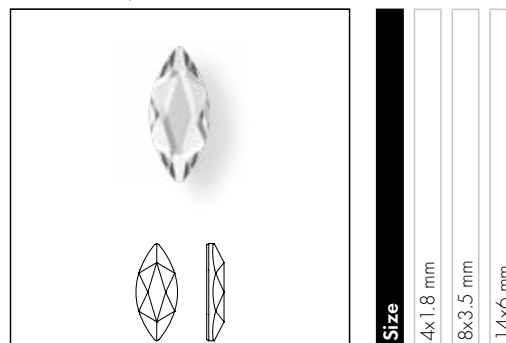

Crystal	
Crystal M HF (001)	■ ■ ■
Crystal Effects	
Transparent Effects	
Crystal Aurore Boreale M HF (001 AB)	■ ■ ■
Crystal Golden Shadow M HF (001 GSHA)	■ ■ ■
Crystal Heliotrope M HF (001 HEL)	■ ■ ■
Crystal Shimmer M HF (001 SHIM)	■ ■ ■

2205 Flame Flat Back

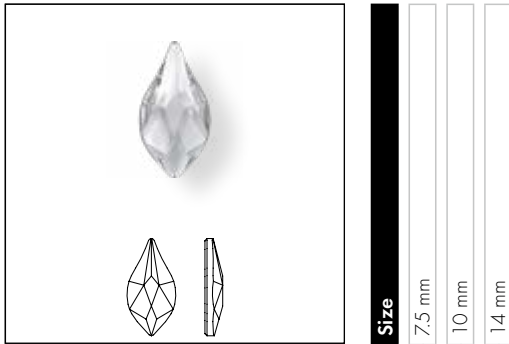

Crystal	7.5 mm	10 mm	14 mm
Crystal M HF (001)	■	■	■
Colors			
TCF™ Colors			
Dark Orange M HF (1202)	■	■	■
Crystal Effects			
Transparent Effects			
Crystal Aurore Boreale M HF (001 AB)	■	■	■
Crystal Golden Shadow M HF (001 GSHA)	■	■	■

2300 Drop Flat Back

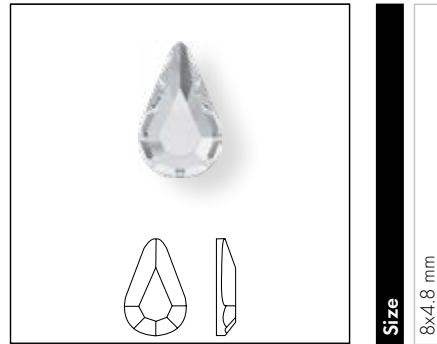

Crystal	8x4.8 mm
Crystal M HF (001)	■
Colors	
Plain Colors	
Aquamarine M HF (202)	■
Black Diamond M HF (215)	■
Emerald M HF (205)	■
Jet M HF (280)	■
Light Colorado Topaz M HF (246)	■
Light Rose M HF (223)	■
Scarlet M HF (276)	■
Crystal Effects	
Transparent Effects	
Crystal Aurore Boreale M HF (001 AB)	■
Crystal Golden Shadow M HF (001 GSHA)	■

2303 Pear Flat Back

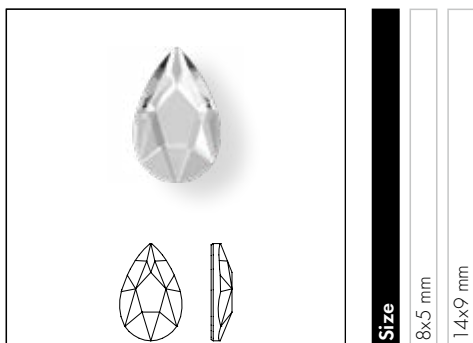

- Crystal**
- Crystal M HF (001)
- Crystal Effects**
- Transparent Effects**
- Crystal Aurore Boreale M HF (001 AB)
- Crystal Golden Shadow M HF (001 GSHA)
- Crystal Heliotrope M HF (001 HEL)
- Crystal Shimmer M HF (001 SHIM)

2304 Raindrop Flat Back

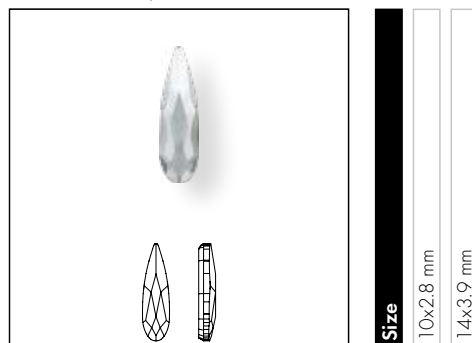

- Crystal**
- Crystal M HF (001)
- Crystal Effects**
- Transparent Effects**
- Crystal Aurore Boreale M HF (001 AB)
- Crystal Golden Shadow M HF (001 GSHA)
- Crystal Heliotrope M HF (001 HEL)
- Crystal Shimmer M HF (001 SHIM)

2400 Square Flat Back

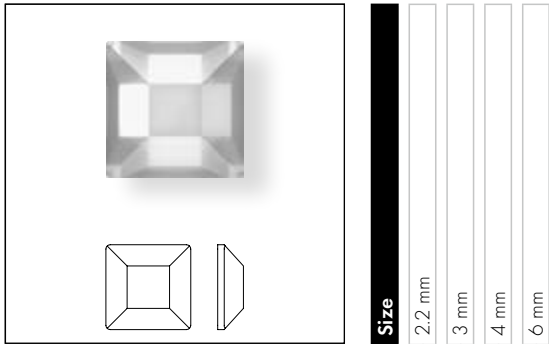

Size
2.2 mm
3 mm
4 mm
6 mm

Crystal	
Crystal M HF (001)	■ ■ ■ ■
Colors	
Plain Colors	
Amethyst M HF (204)	■ ■
Aquamarine M HF (202)	■ ■
Black Diamond M HF (215)	■ ■
Emerald M HF (205)	■ ■
Jet M HF (280)	■ ■ ■
Light Colorado Topaz M HF (246)	■ ■
Light Rose M HF (223)	■ ■
Scarlet M HF (276)	■ ■
ReCreated™ Colors	
ReCreated™ Dark Jonquil M HF (1407)	■ ■
ReCreated™ Light Smoked Topaz M HF (1402)	■ ■
ReCreated™ Peridot M HF (1408)	■ ■
ReCreated™ Smoked Topaz M HF (1403)	■ ■
TCF™ Colors	
Dark Orange M HF (1202 TCF™)	■ ■
Crystal Effects	
Transparent Effects	
Crystal Aurore Boreale M HF (001 AB)	■ ■ ■ ■
Crystal Golden Shadow M HF (001 GSHA)	■ ■ ■ ■
Crystal Heliotrope M HF (001 HEL)	■ ■ ■ ■
Crystal Shimmer M HF (001 SHIM)	■ ■ ■ ■
Crystal Silver Night M HF (001 SINI)	■ ■ ■ ■
Metallic Effects	
Crystal Aurum M HF (001 AUR)	■ ■ ■ ■
Color Effects	
Metallic Effects	
Jet Hematite M HF (280 HEM)	■ ■ ■ ■

2471 Cushion Flat Back

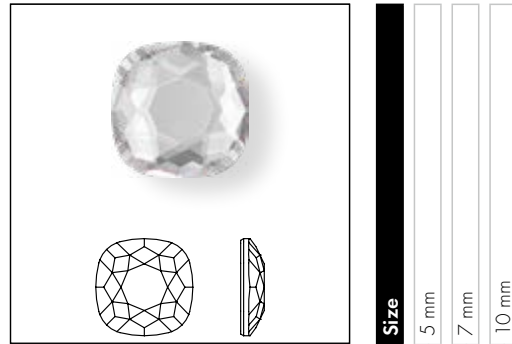

Size
5 mm
7 mm
10 mm

Crystal	
Crystal M HF (001)	■ ■ ■ ■
Colors	
Plain Colors	
Aquamarine M HF (202)	■ ■ ■ ■
Emerald M HF (205)	■ ■ ■ ■
Graphite M HF (253)	■ ■ ■ ■
Jet M HF (280)	■ ■ ■ ■
Sapphire M HF (206)	■ ■ ■ ■
Scarlet M HF (276)	■ ■ ■ ■
Vintage Rose M HF (319)	■ ■ ■ ■
Crystal Effects	
Transparent Effects	
Crystal Aurore Boreale M HF (001 AB)	■ ■ ■ ■
Crystal Golden Shadow M HF (001 GSHA)	■ ■ ■ ■

2472 Trilliant Flat Back

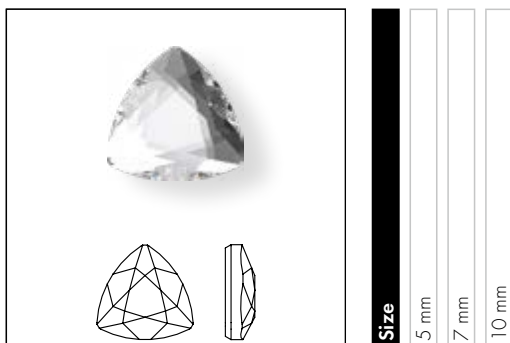

Crystal	5 mm	7 mm	10 mm
Crystal M HF (001)	■	■	■
Colors			
Plain Colors			
Aquamarine M HF (202)	■	■	■
Emerald M HF (205)	■	■	■
Graphite M HF (253)	■	■	■
Jet M HF (280)	■	■	■
Sapphire M HF (206)	■	■	■
Scarlet M HF (276)	■	■	■
Vintage Rose M HF (319)	■	■	■
Crystal Effects			
Transparent Effects			
Crystal Aurore Boreale M HF (001 AB)	■	■	■
Crystal Golden Shadow M HF (001 GSHA)	■	■	■

2510 Baguette Flat Back

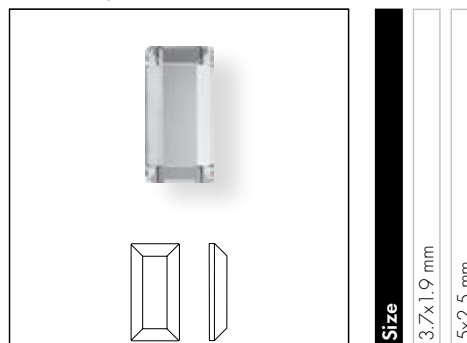

Crystal	3.7x1.9 mm	5x2.5 mm
Crystal M HF (001)	■	■
Colors		
Plain Colors		
Aquamarine M HF (202)	■	■
Black Diamond M HF (215)	■	■
Emerald M HF (205)	■	■
Jet M HF (280)	■	■
Light Colorado Topaz M HF (246)	■	■
ReCreated™ Colors		
ReCreated™ Dark Jonquil M HF (1407)	■	■
ReCreated™ Light Smoked Topaz M HF (1402)	■	■
ReCreated™ Peridot M HF (1408)	■	■
ReCreated™ Smoked Topaz M HF (1403)	■	■
TCF™ Colors		
Dark Orange M HF (1202 TCF™)	■	■
Crystal Effects		
Transparent Effects		
Crystal Aurore Boreale M HF (001 AB)	■	■
Crystal Golden Shadow M HF (001 GSHA)	■	■
Crystal Heliotrope M HF (001 HEL)	■	■
Crystal Shimmer M HF (001 SHIM)	■	■
Metallic Effects		
Crystal Aurum M HF (001 AUR)	■	■

2555 Cosmic Baguette Flat Back

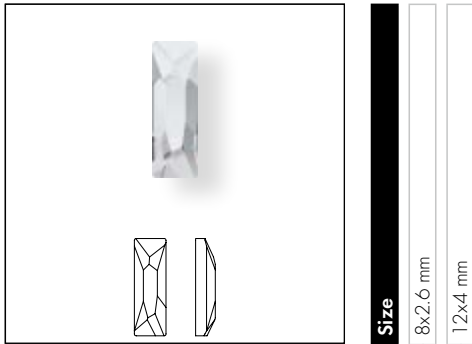

Size

8x2.6 mm

12x4 mm

Crystal

Crystal M HF (001)

Crystal Effects

Transparent Effects

Crystal Aurore Boreale M HF (001 AB)

Crystal Golden Shadow M HF (001 GSHA)

2602 Emerald Cut Flat Back

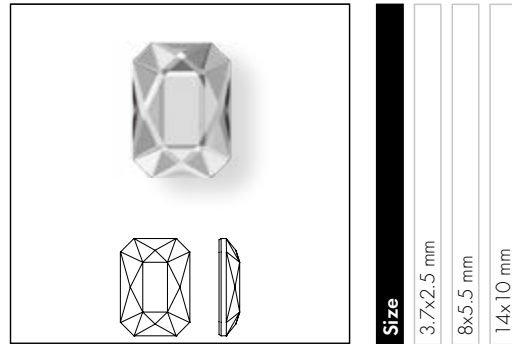

Size

3.7x2.5 mm

8x5.5 mm

14x10 mm

Crystal

Crystal M HF (001)

Colors

Plain Colors

Aquamarine M HF (202)

Emerald M HF (205)

Graphite M HF (253)

Jet M HF (280)

Sapphire M HF (206)

Scarlet M HF (276)

Vintage Rose M HF (319)

Crystal Effects

Transparent Effects

Crystal Aurore Boreale M HF (001 AB)

Crystal Golden Shadow M HF (001 GSHA)

Crystal Heliotrope M HF (001 HEL)

Crystal Shimmer M HF (001 SHIM)

2603 Oval Flat Back

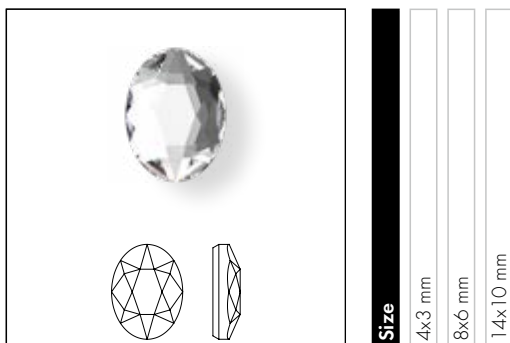

Size
4x3 mm
8x6 mm
14x10 mm

Crystal

Crystal M HF (001)

Colors

Plain Colors

Aquamarine M HF (202)

Emerald M HF (205)

Graphite M HF (253)

Jet M HF (280)

Sapphire M HF (206)

Scarlet M HF (276)

Vintage Rose M HF (319)

Crystal Effects

Transparent Effects

Crystal Aurore Boreale M HF (001 AB)

Crystal Golden Shadow M HF (001 GSHA)

2709 Rhombus Flat Back

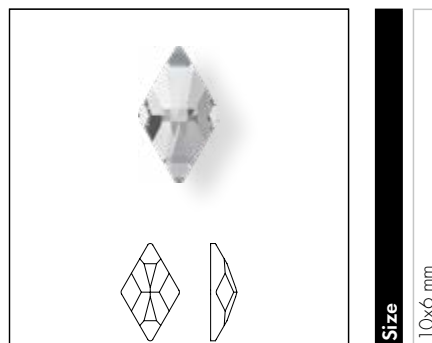

Size
10x6 mm

Crystal

Crystal M HF (001)

Crystal Effects

Transparent Effects

Crystal Aurore Boreale M HF (001 AB)

Crystal Golden Shadow M HF (001 GSHA)

2711 Triangle Flat Back

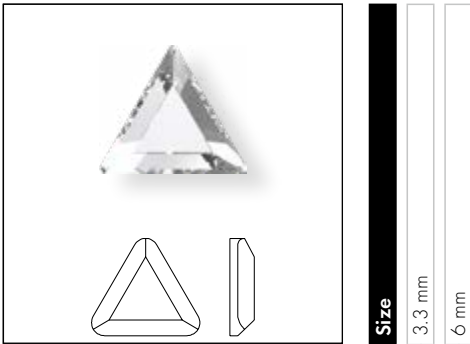

Size
3.3 mm
6 mm

- Crystal**
- Crystal M HF (001)
- Colors**
- Plain Colors**
- Jet M HF (280)
- Crystal Effects**
- Transparent Effects**
- Crystal Aurore Boreale M HF (001 AB)
- Crystal Golden Shadow M HF (001 GSHA)

2715 Connector Flat Back

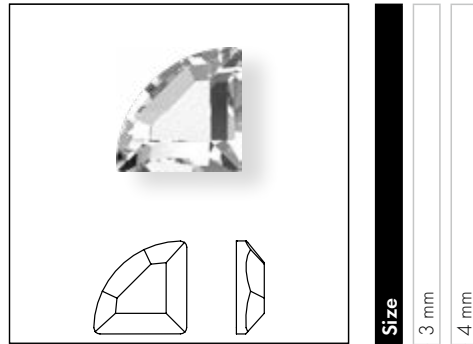

Size
3 mm
4 mm

- Crystal**
- Crystal M HF (001)
- Colors**
- Plain Colors**
- Amethyst M HF (204)
- Aquamarine M HF (202)
- Emerald M HF (205)
- Jet M HF (280)
- Light Colorado Topaz M HF (246)
- Scarlet M HF (276)
- Crystal Effects**
- Transparent Effects**
- Crystal Aurore Boreale M HF (001 AB)
- Crystal Golden Shadow M HF (001 GSHA)
- Crystal Silver Night M HF (001 SINI)
- Metallic Effects**
- Crystal Light Chrome M HF (001 LTCH)
- Color Effects**
- Metallic Effects**
- Jet Hematite M HF (280 HEM)

TRIANGLE FAMILY

2738 Triangle Alpha Flat Back

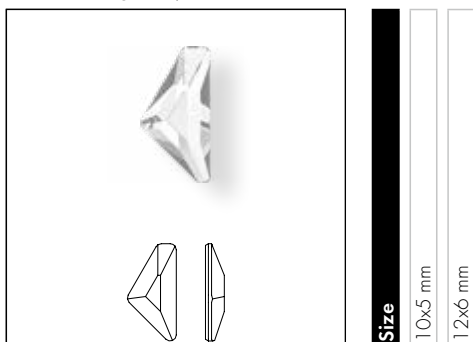

Size
10x5 mm
12x6 mm

- Crystal**
- Crystal M HF (001)
- Crystal Effects**
- Transparent Effects**
- Crystal Aurore Boreale M HF (001 AB)
- Crystal Golden Shadow M HF (001 GSHA)
- Crystal Silver Night M HF (001 SINI)

2739 Triangle Beta Flat Back



Size
5.8x5.3 mm
7x6.5 mm

- Crystal**
- Crystal M HF (001)
- Crystal Effects**
- Transparent Effects**
- Crystal Aurore Boreale M HF (001 AB)
- Crystal Golden Shadow M HF (001 GSHA)
- Crystal Silver Night M HF (001 SINI)

2740 Triangle Gamma Flat Back

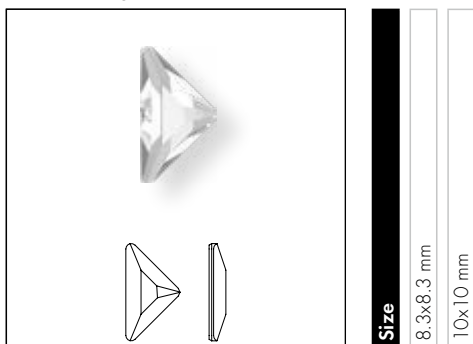

Size
8.3x8.3 mm
10x10 mm

- Crystal**
- Crystal M HF (001)
- Crystal Effects**
- Transparent Effects**
- Crystal Aurore Boreale M HF (001 AB)
- Crystal Golden Shadow M HF (001 GSHA)
- Crystal Silver Night M HF (001 SINI)

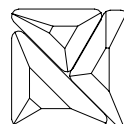

When Alpha, Beta, and Gamma Flat Backs are arranged together, they form a square.

2754 Star Flower Flat Back HF

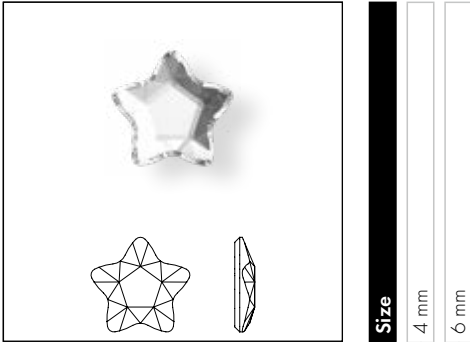

Crystal	
Crystal M HF (001)	■ ■
Colors	
Plain Colors	
Amethyst M HF (204)	■ ■
Aquamarine M HF (202)	■ ■
Iris M HF (219)	■ ■
Jet M HF (280)	■ ■
Light Rose M HF (223)	■ ■
Light Topaz M HF (226)	■ ■
Rose M HF (209)	■ ■
Scarlet M HF (276)	■ ■
ReCreated™ Colors	
ReCreated™ Peridot M HF (1408)	■ ■
TCF™ Colors	
Dark Rose M HF (1201 TCF™)	■ ■
Crystal Effects	
Transparent Effects	
Crystal Aurore Boreale M HF (001 AB)	■ ■
Crystal Golden Shadow M HF (001 GSHA)	■ ■

2770 Wing Flat Back

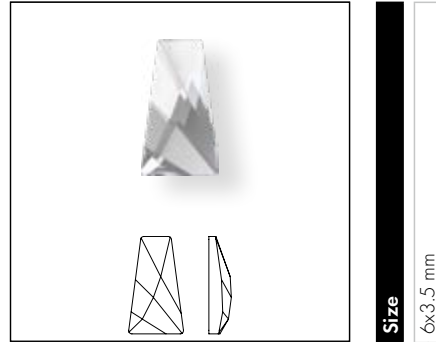

Crystal	
Crystal M HF (001)	■
Crystal Effects	
Transparent Effects	
Crystal Aurore Boreale M HF (001 AB)	■

2771 Kite Flat Back

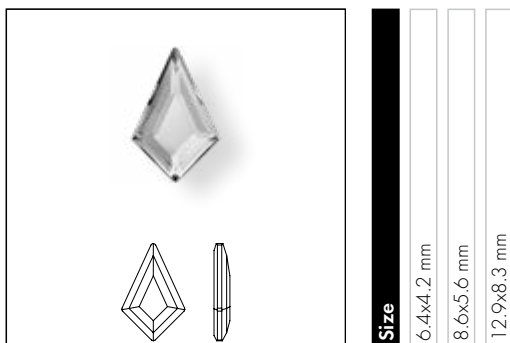

Size

6.4x4.2 mm
8.6x5.6 mm
12.9x8.3 mm

Crystal

Crystal M HF (001)

Colors

Plain Colors

Black Diamond M HF (215)

Light Rose M HF (223)

Light Siam M HF (227)

Crystal Effects

Transparent Effects

Crystal Aurore Boreale M HF (001 AB)

Crystal Golden Shadow M HF (001 GSHA)

Crystal Shimmer M HF (001 SHIM)

Color Effects

Metallic Effects

Jet Hematite M HF (280 HEM)

2772 Trapeze Flat Back

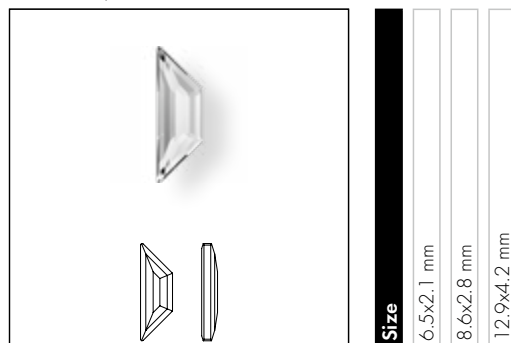

Size

6.5x2.1 mm
8.6x2.8 mm
12.9x4.2 mm

Crystal

Crystal M HF (001)

Colors

Plain Colors

Black Diamond M HF (215)

Crystal Effects

Transparent Effects

Crystal Aurore Boreale M HF (001 AB)

Crystal Golden Shadow M HF (001 GSHA)

Color Effects

Metallic Effects

Jet Hematite M HF (280 HEM)

2773 Diamond Shape Flat Back

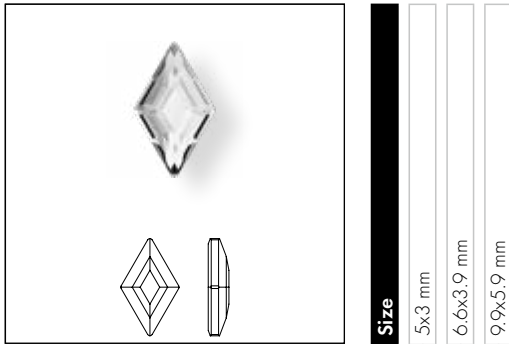

Crystal	5x3 mm	6.6x3.9 mm	9.9x5.9 mm
Crystal M HF (001)	■	■	■
Colors			
Plain Colors			
Black Diamond M HF (215)	■	■	■
Light Rose M HF (223)	■	■	■
Light Siam M HF (227)	■	■	■
Crystal Effects			
Transparent Effects			
Crystal Aurore Boreale M HF (001 AB)	■	■	■
Crystal Golden Shadow M HF (001 GSHA)	■	■	■
Crystal Shimmer M HF (001 SHIM)	■	■	
Color Effects			
Metallic Effects			
Jet Hematite M HF (280 HEM)	■	■	■

2774 Elongated Pentagon Flat Back

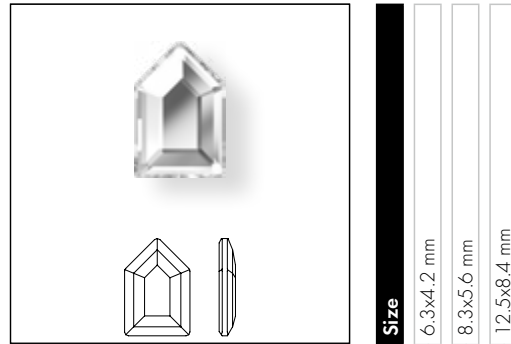

Crystal	6.3x4.2 mm	8.3x5.6 mm	12.5x8.4 mm
Crystal M HF (001)	■	■	■
Colors			
Plain Colors			
Black Diamond M HF (215)	■		
Light Siam M HF (227)	■		
Crystal Effects			
Transparent Effects			
Crystal Aurore Boreale M HF (001 AB)	■	■	■
Color Effects			
Metallic Effects			
Jet Hematite M HF (280 HEM)	■		

2775 Concise Pentagon Flat Back

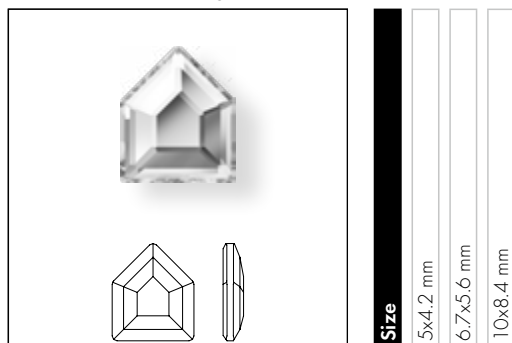

Size

5x4.2 mm

6.7x5.6 mm

10x8.4 mm

Crystal

Crystal M HF (001)

Colors

Plain Colors

Black Diamond M HF (215)

Light Siam M HF (227)

Crystal Effects

Transparent Effects

Crystal Aurore Boreale M HF (001 AB)

Color Effects

Metallic Effects

Jet Hematite M HF (280 HEM)

2776 Elongated Hexagon Flat Back

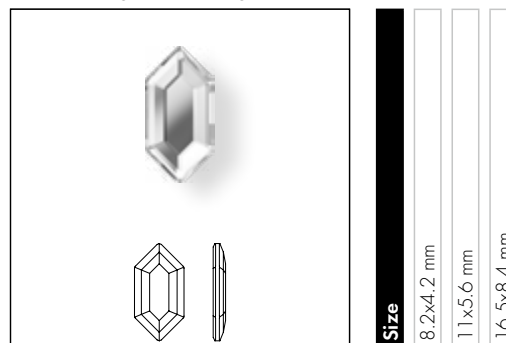

Size

8.2x4.2 mm

11x5.6 mm

16.5x8.4 mm

Crystal

Crystal M HF (001)

Colors

Plain Colors

Black Diamond M HF (215)

Light Siam M HF (227)

Crystal Effects

Transparent Effects

Crystal Aurore Boreale M HF (001 AB)

Color Effects

Metallic Effects

Jet Hematite M HF (280 HEM)

2777 Concise Hexagon Flat Back

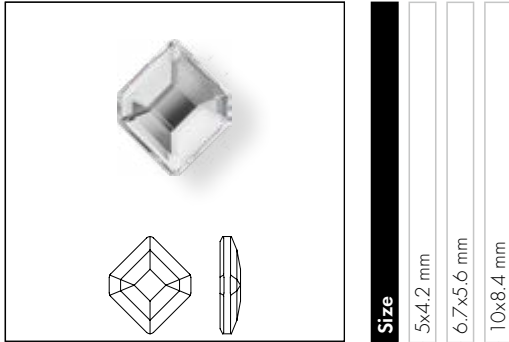

Size
5x4.2 mm
6.7x5.6 mm
10x8.4 mm

- Crystal**
- Crystal M HF (001)
- Colors**
- Plain Colors**
- Black Diamond M HF (215)
- Light Siam M HF (227)
- Crystal Effects**
- Transparent Effects**
- Crystal Aurore Boreale M HF (001 AB)
- Color Effects**
- Metallic Effects**
- Jet Hematite M HF (280 HEM)

2808 Heart Flat Back

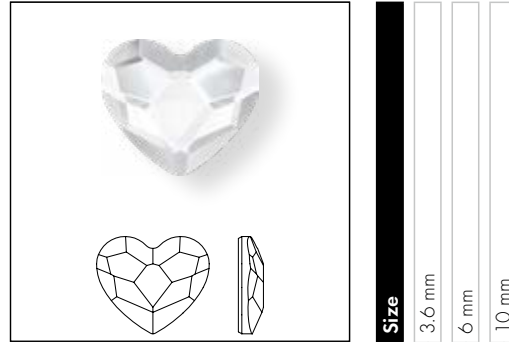

Size
3.6 mm
6 mm
10 mm

- Crystal**
- Crystal M HF (001)
- Colors**
- Plain Colors**
- Fuchsia M HF (502)
- Jet M HF (280)
- Light Siam M HF (227)
- TCF™ Colors**
- Dark Rose M HF (1201)
- Crystal Effects**
- Transparent Effects**
- Crystal Aurore Boreale M HF (001 AB)
- Crystal Golden Shadow M HF (001 GSHA)

2788 Wave Flat Back

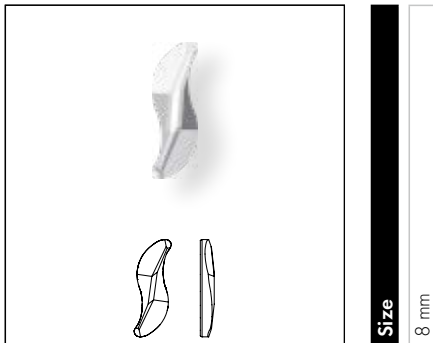

Size
8 mm

- Crystal**
- Crystal M HF (001)
- Crystal Effects**
- Transparent Effects**
- Crystal Aurore Boreale M HF (001 AB)

2813 Moon Flat Back Hotfix

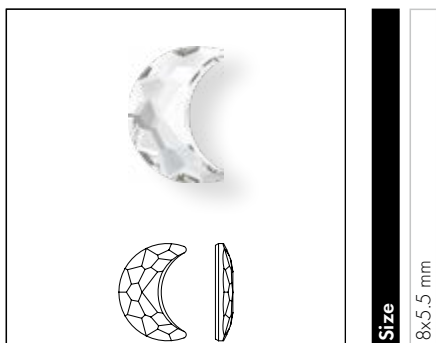

- Crystal**
- Crystal M HF (001)
- Crystal Effects**
- Transparent Effects**
- Crystal Aurore Boreale M HF (001 AB)

2816 Rivoli Star Flat Back

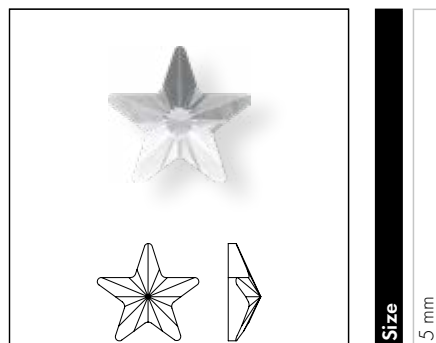

- Crystal**
- Crystal M HF (001)
- Colors**
- Plain Colors**
- Jet M HF (280)
- Crystal Effects**
- Transparent Effects**
- Crystal Aurore Boreale M HF (001 AB)
- Color Effects**
- Metallic Effects**
- Jet Hematite M HF (280 HEM)

Product Details

Article Size	Packing Unit = Minimum Order Quantity in Pieces	Average Net Weight in Gram per Packing Unit Crystal (001)	Average Gross Weight in Gram per Packing Unit Crystal (001)
1098 A HF			
PP 24 (SS 12)	1440	20.96	31.16
PP 31 (SS 16)	1440	41.13	51.33
SS 20	720	36.58	46.78
2000 A HF			
SS 3	1,440	1.8	12.7
2038 A HF			
SS 5	1,440	4.2	12.1
SS 6	1,440	5.4	17.7
SS 8	1,440	9.96	18.2
SS 10	1,440	15.54	24.3
2038/1			
SS 10	1440	15.7	24.4
2078 A HF			
SS 12	1,440	21.6	30.4
SS 16	1,440	39.1	47.1
SS 20	1,440	72.0	79.6
SS 30	288	34.6	63.0
SS 34	144	26.0	48.6
SS 40	144	43.2	66.9
SS 48	96	61.4	87.4
2078/1 A HF			
SS 16	1,440	39.1	47.1
SS 20	1,440	72.0	79.6
2080/4 HF			
SS 6	1,440	6.5	16.7
SS 10	1,440	17.1	28.3
SS 16	1,440	43.4	54.9
SS 20	1,440	82.9	93.1
SS 34	144	23.2	34.1
2100 M HF			
SS 12	1,440	22.1	32.3
SS 16	1,440	34.1	44.3
SS 20	1,440	67.5	77.7
SS 30	288	33.5	56.7
SS 34	144	22.5	47.6
SS 40	144	34.0	59.1
SS 48	96	47.1	70.9
2200 M HF			
4x2 mm	720	6.5	18.5
8x4 mm	360	24.8	35.8
2201 M HF			
4x1.8 mm	720	5.7	15.9
8x3.5 mm	144	10.03	31.11
14x6 mm	72	21.67	45.27

Article Size	Packing Unit = Minimum Order Quantity in Pieces	Average Net Weight in Gram per Packing Unit Crystal (001)	Average Gross Weight in Gram per Packing Unit Crystal (001)
2205 M HF			
7.5 mm	288	20.3	30.5
10 mm	144	17.6	42.4
14 mm	72	22.3	45.9
2300 M HF			
8x4.8 mm	360	41.9	51.0
2303 M HF			
8x5 mm	144	15.70	39.60
14x9 mm	72	36.65	60.25
2304 M HF			
10x2.8 mm	180	10.2	20.4
14x3.9 mm	96	13.1	36.3
2400 M HF			
2.2 mm	1,440	9.65	18.5
3 mm	1,440	25.3	36.8
4 mm	720	30.0	41.0
6 mm	144	21.9	32.7
2471 M HF			
5 mm	288	17.3	25.6
7 mm	72	11.9	35.1
10 mm	72	30.2	51.6
2472 M HF			
5 mm	288	17.4	27.6
7 mm	144	20.8	42.8
10 mm	96	34.5	56.5
2510 M HF			
3.7x1.9 mm	720	8.2	10.6
5x2.5 mm	720	23.2	32.3
2555 M HF			
8x2.6 mm	240	18.4	27.5
12x4 mm	144	28.8	33.6
2602 M HF			
3.7x2.5 mm	720	11.5	21.7
8x5.5 mm	144	17.89	41.79
14x10 mm	72	58.61	82.21
2603 M HF			
4x3 mm	288	6.8	17.0
8x6 mm	144	21.7	43.7
14x10 mm	72	50.3	72.3
2709 M HF			
10x6 mm	288	28.9	67.2
2711 M HF			
3.3 mm	720	6.38	15.63
6 mm	360	29.7	40.7

Article Size	Packing Unit = Minimum Order Quantity in Pieces	Average Net Weight in Gram per Packing Unit Crystal (001)	Average Gross Weight in Gram per Packing Unit Crystal (001)
2715 M HF			
3 mm	288	4.0	14.2
4 mm	288	8.2	18.4
2716 M HF			
5 mm	720	35.8	75.1
2738 M HF			
10x5 mm	144	16.7	35.1
12x6 mm	96	20.2	38.3
2739 M HF			
5.8x5.3 mm	216	19.2	41.9
7x6.5 mm	144	22.6	39.8
2740 M HF			
8.3x8.3 mm	216	35.1	54.2
10x10 mm	96	25.1	41.1
2754 M HF			
4 mm	720	13.6	23.8
6 mm	360	20.5	30.7
2770 M HF			
6x3.5 mm	1,440	60.3	70.3
2771 M HF			
6.4x4.2 mm	288	9.04	17.87
8.6x5.6 mm	216	16.84	43.02
12.9x8.3 mm	144	36.29	61.39
2772 M HF			
6.5x2.1 mm	288	6.39	15.17
8.6x2.8 mm	288	16.29	40.71
12.9x4.2 mm	144	25.57	53.86
2773 M HF			
5x3 mm	288	4.83	13.66
6.6x3.9 mm	288	11.23	35.65
9.9x5.9 mm	144	19.30	43.39
2774 M HF			
6.3x4.2 mm	288	18.7	29.6
8.3x5.6 mm	144	19.5	39.4
12.5x8.4 mm	96	39.0	60.3
2775 M HF			
5x4.2 mm	288	13.9	24.7
6.7x5.6 mm	144	15.0	34.3
10x8.4 mm	144	43.6	66.4
2776 M HF			
8.2x4.2 mm	144	11.2	30.1
11x5.6 mm	72	11.3	28.8
16.5x8.4 mm	72	35.6	55.8

Article Size	Packing Unit = Minimum Order Quantity in Pieces	Average Net Weight in Gram per Packing Unit Crystal (001)	Average Gross Weight in Gram per Packing Unit Crystal (001)
2777 M HF			
5x4.2 mm	288	10.4	21.3
6.7x5.6 mm	144	10.5	29.7
10x8.4 mm	144	32.8	52.7
2788 M HF			
8 mm	288	7.5	18.4
2808 M HF			
3.6 mm	720	18.4	20.8
6 mm	288	19.8	28.9
10 mm	144	38.8	55.9
2813 M HF			
8x5.5 mm	144	13.1	37.7
2816 M HF			
5 mm	720	23.6	30.7



Sew-on Articles & Crystal Buttons

04

Sew-on Articles and Crystal Buttons are just what their names suggest: sparkling loose crystals with holes that offer convenient sewing options. Perfect for hand-sewing or easily applied using a standard or industrial embroidery sewing machine, they can be effortlessly added to fabric and other materials bringing instant brilliance and style.

The radiant heroes of this product group – Article 3188 XIRIUS Lochrose and Article 3288 XIRIUS Sew-on Stones – feature our innovative multi-layer cutting technology that creates the striking XIRIUS design. These completely unique and exceptional crystals set themselves apart as some of the most advanced and distinctive designs available on the market.

Colors & Effects

Colors

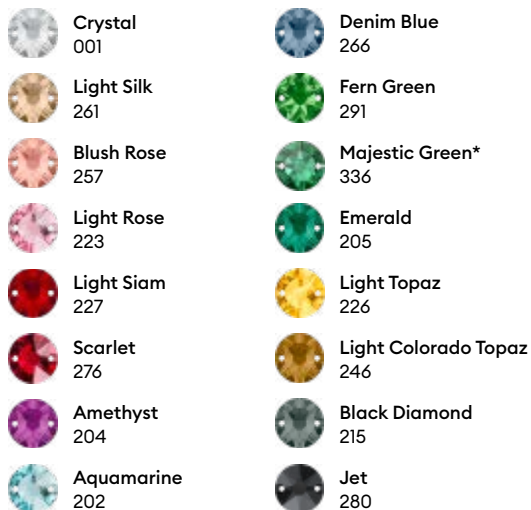

Swarovski ReCreated™ Colors



Effects



*this color does not exist for 3288, but for other Sew-on Articles. For more details, please see the product matrix on the respective items.

Colors & Effects

Numerical Order

001	Crystal	202	Aquamarine	266	Denim Blue
001 AB	Crystal Aurore Boreale	204	Amethyst	276	Scarlet
001 AUR	Crystal Aurum	205	Emerald	280 HEM	Jet Hematite
001 GSHA	Crystal Golden Shadow	215	Black Diamond	280	Jet
001 METSH	Crystal Metallic Sunshine	223	Light Rose	291	Fern Green
001 MOL	Crystal Moonlight	226	Light Topaz	336	Majestic Green
001 SHIM	Crystal Shimmer	227	Light Siam	1407	ReCreated™ Dark Jonquil
001 SINI	Crystal Silver Night	246	Light Colorado Topaz	1408	ReCreated™ Peridot
001 SSHA	Crystal Silver Shade	257	Blush Rose		
001 VM	Crystal Vitrail Medium	261	Light Silk		

Alphabetical Order

Amethyst (204)	Crystal Shimmer (001 SHIM)	Light Rose (223)
Aquamarine (202)	Crystal Silver Night (001 SINI)	Light Siam (227)
Black Diamond (215)	Crystal Silver Shade (001 SSHA)	Light Silk (261)
Blush Rose (257)	Crystal Vitrail Medium (001 VM)	Light Topaz (226)
Crystal (001)	Denim Blue (266)	Majestic Green (336)
Crystal Aurore Boreale (001 AB)	Emerald (205)	ReCreated™ Dark Sapphire (1404)
Crystal Aurum (001 AUR)	Fern Green (291)	ReCreated™ Peridot (1408)
Crystal Golden Shadow (001 GSHA)	Jet (280)	Scarlet (276)
Crystal Metallic Sunshine (001 METSH)	Jet Hematite (280 HEM)	
Crystal Moonlight (001 MOL)	Light Colorado Topaz (246)	

For details on available colors and effects for each article within the product groups, please see the product matrix of the respective item in the Collection 2026.

The plating resistance of effects is tested according to Swarovski's plating guidelines (SWAROVSKI.COM/S-PROFESSIONALS). Customers are advised to carry out their own tests if their plating parameters diverge from Swarovski plating guidelines.



Colors and effects can appear different when illuminated with different light sources. Swarovski uses standard light source D65 for color decision and comparison. Slight changes in shades are unavoidable. Colors may vary according to cut and foiling.

The composition of Advanced Crystal is compliant with regulatory industry norms and laws regarding the restriction or prohibition of certain substances in the most relevant segments of our customers. Please note that the compliance of the colors Light Siam and Siam varies according to certain industry regulations. Those regulations are indicated with * in the compliance overview. Indian Siam, Ruby and Scarlet (option to Lt. Siam) conform to all CLEAR-lists. For further information please visit swarovski.com/s-professionals

© 2026 D. Swarovski Distribution GmbH

Sew-on Articles

Summary

- | | | | | | |
|---|---|---|---|---|------------------------------------|
| 1 | 2 | | 1 | 2 | |
|  |  | 3188
3, 4, 5, 6, 7, 8 mm |  |  | 3288
8, 10, 12 mm |
|  |  | 3200
3, 10, 12, 14, 16, 18 mm |  |  | 3700
6, 8, 10, 12, 14 mm |
|  |  | 3210
10x7, 16x11, 24x17 mm |  |  | 3754
5, 7 mm |
|  |  | 3223
12x6, 18x9,
29x14.5 mm | | | |
|  |  | 3230
12x7, 18x10.5, 23x13.8,
28x17, 34x20.4 mm | | | |
|  |  | 3240
16, 22 mm | | | |
|  |  | 3252
14x10, 20x14,
28x20 mm | | | |
|  |  | 3255
18x6, 26x8.5 mm | | | |
|  |  | 3256
14x8.5, 19x11.5,
27x16 mm | | | |
|  |  | 3265
20x16, 26x21 mm | | | |
|  |  | 3270
16, 22 mm | | | |

1 Top view 2 Side view

3188 XIRIUS Lochrose

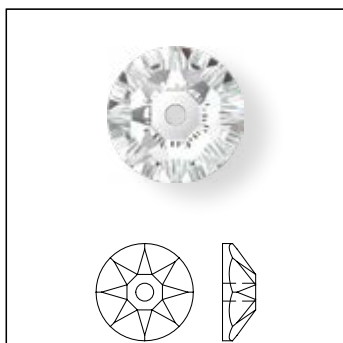

Size	3 mm	4 mm	5 mm	6 mm	7 mm	8 mm
------	------	------	------	------	------	------

Crystal

- Crystal (001)
- Crystal F (001)

Colors

Plain Colors

- Aquamarine F (202)
- Black Diamond F (215)
- Blush Rose F (257)
- Denim Blue F (266)
- Emerald F (205)
- Jet (280)
- Light Colorado Topaz F (246)
- Light Rose F (223)
- Light Siam F (227)
- Light Silk F (261)
- Scarlet F (276)

ReCreated™ Colors

- ReCreated™ Dark Jonquil F (1407)

Crystal Effects

Transparent Effects

- Crystal Aurore Boreale F (001 AB)
- Crystal Golden Shadow F (001 GSHA)
- Crystal Moonlight F (001 MOL)
- Crystal Shimmer F (001 SHIM)
- Crystal Silver Night (001 SINI)
- Crystal Silver Shade F (001 SSHA)

Metallic Effects

- Crystal Aurum F (001 AUR)
- Crystal Metallic Sunshine F (001 METSH)

Color Effects

Metallic Effects

- Jet Hematite (280 HEM)

Crystal (001)	■	■	■			
Crystal F (001)	■	■	■	■	■	■
Aquamarine F (202)	■	■	■			
Black Diamond F (215)	■	■	■			
Blush Rose F (257)	■	■	■			
Denim Blue F (266)	■	■	■			
Emerald F (205)	■	■	■			
Jet (280)	■	■	■	■	■	■
Light Colorado Topaz F (246)	■	■	■			
Light Rose F (223)	■	■	■			
Light Siam F (227)	■	■	■			
Light Silk F (261)	■	■	■			
Scarlet F (276)	■	■	■			
ReCreated™ Dark Jonquil F (1407)	■	■	■			
Crystal Aurore Boreale F (001 AB)	■	■	■	■	■	■
Crystal Golden Shadow F (001 GSHA)	■	■	■	■	■	■
Crystal Moonlight F (001 MOL)	■	■	■			
Crystal Shimmer F (001 SHIM)	■	■	■			
Crystal Silver Night (001 SINI)		■	■			
Crystal Silver Shade F (001 SSHA)	■	■	■			
Crystal Aurum F (001 AUR)	■	■	■			
Crystal Metallic Sunshine F (001 METSH)	■	■	■			
Jet Hematite (280 HEM)	■	■	■			

3200 Rivoli Sew-on Stone

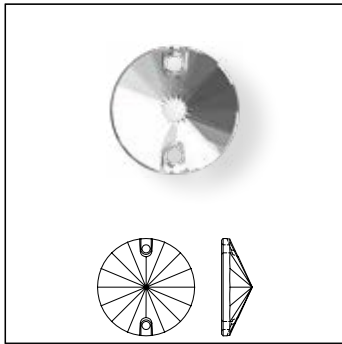

Size	8 mm	10 mm	12 mm	14 mm	16 mm	18 mm
------	------	-------	-------	-------	-------	-------

Crystal	
Crystal F (001)	Available in all sizes
Colors	
Plain Colors	
Aquamarine F (202)	Available in 10, 12, 14, 16 mm
Black Diamond F (215)	Available in 10, 12, 14, 16 mm
Emerald F (205)	Available in 10, 12, 14, 16 mm
Jet (280)	Available in all sizes
Light Colorado Topaz F (246)	Available in 10, 12, 14, 16 mm
Light Rose F (223)	Available in 10, 12, 14, 16 mm
Light Siam F (227)	Available in 10, 12, 14, 16 mm
Scarlet F (276)	Available in 10, 12, 14, 16 mm
ReCreated™ Colors	
ReCreated™ Dark Jonquil F (1407)	Available in 10, 12, 14, 16 mm
Crystal Effects	
Transparent Effects	
Crystal Aurore Boreale F (001 AB)	Available in all sizes
Crystal Golden Shadow F (001 GSHA)	Available in 10, 12, 14, 16 mm
Crystal Shimmer F (001 SHIM)	Available in 10, 12, 14, 16 mm
Metallic Effects	
Crystal Metallic Sunshine F (001 METSH)	Available in 10, 12, 14, 16 mm
Color Effects	
Metallic Effects	
Jet Hematite (280 HEM)	Available in 10, 12, 14, 16 mm

3210 Oval Sew-on Stone

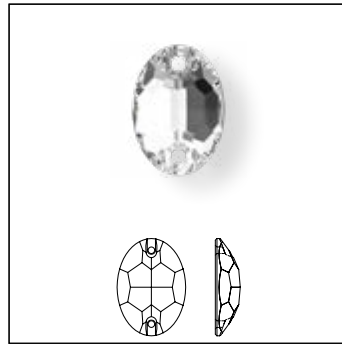

Size	10x7 mm	16x11 mm	24x17 mm
------	---------	----------	----------

Crystal	
Crystal F (001)	Available in all sizes
Colors	
Plain Colors	
Jet (280)	Available in all sizes
Crystal Effects	
Transparent Effects	
Crystal Aurore Boreale F (001 AB)	Available in all sizes

3223 Navette Sew-on Stone

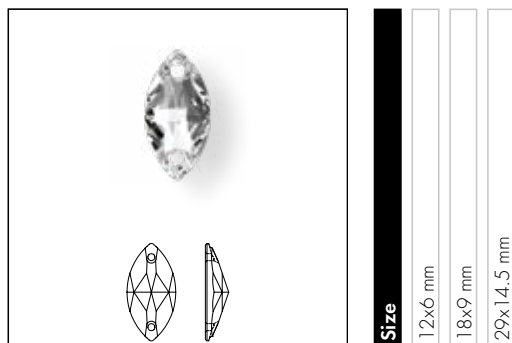

Size
12x6 mm
18x9 mm
29x14.5 mm

Crystal	12x6 mm	18x9 mm	29x14.5 mm
Crystal F (001)	■	■	■
Colors			
Plain Colors			
Aquamarine F (202)	■	■	
Black Diamond F (215)	■	■	
Emerald F (205)	■	■	
Jet (280)	■	■	■
Light Colorado Topaz F (246)	■	■	
ReCreated™ Colors			
ReCreated™ Dark Jonquil F (1407)	■	■	
Crystal Effects			
Transparent Effects			
Crystal Aurore Boreale F (001 AB)	■	■	■
Crystal Golden Shadow F (001 GSHA)	■	■	■
Crystal Shimmer F (001 SHIM)	■	■	

3230 Drop Sew-on (Size Extension)



Size
12x7 mm
18x10.5 mm
23x13.8 mm
28x17 mm
34x20.4 mm

Crystal	12x7 mm	18x10.5 mm	23x13.8 mm	28x17 mm	34x20.4 mm
Crystal F (001)	■	■	■	■	■
Colors					
Plain Colors					
Aquamarine F (202)	■	■	■	■	
Black Diamond F (215)	■	■	■	■	
Emerald F (205)	■	■	■	■	
Jet (280)	■	■	■	■	■
Light Colorado Topaz F (246)	■	■	■	■	
Light Rose F (223)	■	■	■	■	
Scarlet F (276)	■	■	■	■	
ReCreated™ Colors					
ReCreated™ Dark Jonquil F (1407)	■	■	■	■	
Crystal Effects					
Transparent Effects					
Crystal Aurore Boreale F (001 AB)	■	■	■	■	■
Crystal Golden Shadow F (001 GSHA)	■	■	■	■	■
Crystal Shimmer F (001 SHIM)	■	■	■	■	
Crystal Silver Night (001 SINI)	■	■	■	■	
Metallic Effects					
Crystal Aurum F (001 AUR)	■	■	■		

3240 Square Sew-on Stone

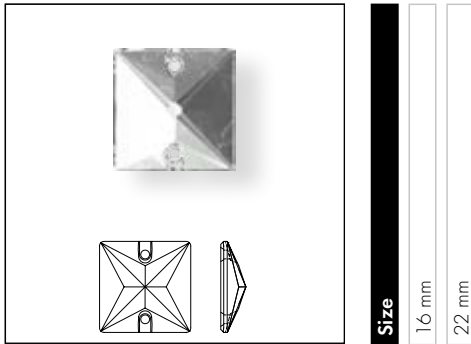

Crystal	
Crystal F (001)	
Colors	
Plain Colors	
Jet (280)	
Crystal Effects	
Transparent Effects	
Crystal Aurore Boreale F (001 AB)	

3252 Emerald Cut Sew-on Stone

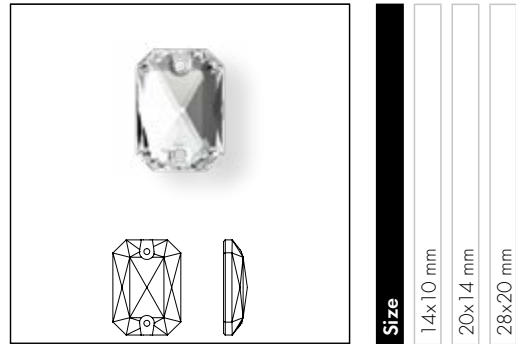

Crystal	
Crystal F (001)	
Colors	
Plain Colors	
Jet (280)	
Crystal Effects	
Transparent Effects	
Crystal Aurore Boreale F (001 AB)	

3255 Cosmic Baguette Sew-on Stone

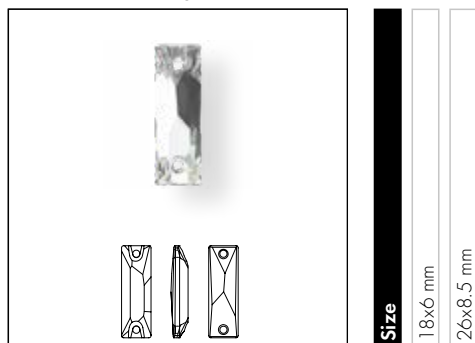

Size

18x6 mm

26x8.5 mm

Crystal

Crystal F (001)

Colors

Plain Colors

Jet (280)

Crystal Effects

Transparent Effects

Crystal Aurore Boreale F (001 AB)

3256 Galactic Sew-on Stone

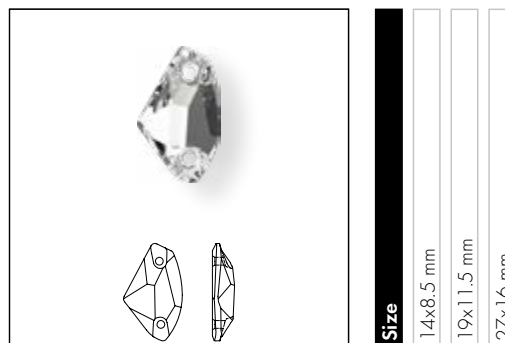

Size

14x8.5 mm

19x11.5 mm

27x16 mm

Crystal

Crystal F (001)

Colors

Plain Colors

Jet (280)

Crystal Effects

Transparent Effects

Crystal Aurore Boreale F (001 AB)

3265 Cosmic Sew-on Stone



Size

20x16 mm

26x21 mm

Crystal

Crystal F (001)

Colors

Plain Colors

Jet (280)

Crystal Effects

Transparent Effects

Crystal Aurore Boreale F (001 AB)

3270 Triangle Sew-on Stone

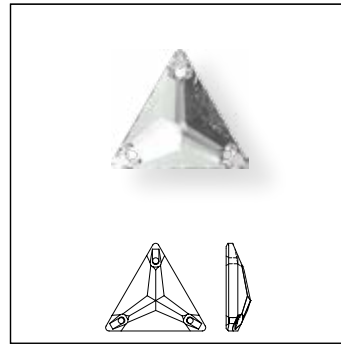

Size

16 mm

22 mm

Crystal

Crystal F (001)

Colors

Plain Colors

Jet (280)

Crystal Effects

Transparent Effects

Crystal Aurore Boreale F (001 AB)

3288 XIRIUS Sew-on Stone

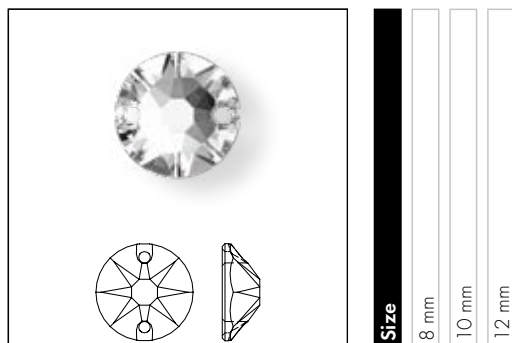

Crystal

Crystal F (001)

Colors

Plain Colors

Aquamarine F (202)

Black Diamond F (215)

Blush Rose F (257)

Denim Blue F (266)

Emerald F (205)

Jet (280)

Light Colorado Topaz F (246)

Light Rose F (223)

Light Siam F (227)

Scarlet F (276)

Crystal Effects

Transparent Effects

Crystal Aurore Boreale F (001 AB)

Crystal Golden Shadow F (001 GSHA)

Crystal Moonlight F (001 MOL)

Crystal Shimmer F (001 SHIM)

Crystal Silver Night (001 SINI)

Crystal Silver Shade F (001 SSHA)

Metallic Effects

Crystal Metallic Sunshine F (001 METSH)

Color Effects

Metallic Effects

Jet Hematite (280 HEM)

3700 Marguerite Lochrose

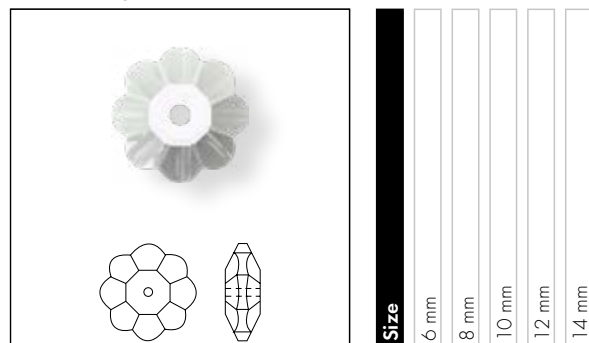

Crystal

Crystal (001)

Crystal F (001)

Colors

Plain Colors

Fern Green (291)

Jet (280)

Light Siam (227)

Majestic Green (336)

ReCreated™ Colors

ReCreated™ Peridot (1408)

Crystal Effects

Transparent Effects

Crystal Aurore Boreale (001 AB)

Crystal Golden Shadow (001 GSHA)

Crystal Shimmer (001 SHIM)

Crystal Vitrail Medium (001 VM)

3754 Star Flower Sew-on Stone

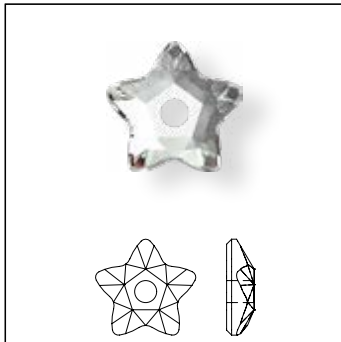

Size	5 mm	7 mm
------	------	------

Crystal

Crystal F (001)

Colors

Plain Colors

Amethyst F (204)

Aquamarine F (202)

Emerald F (205)

Iris F (219)

Jet (280)

Light Rose F (223)

Light Topaz F (226)

Scarlet F (276)

Crystal Effects

Transparent Effects

Crystal Aurore Boreale F (001 AB)

Crystal Golden Shadow F (001 GSHA)

Product Details

Article Size	Packing Unit = Minimum Order Quantity in Pieces	Average Net Weight in Gram per Packing Unit Crystal (001)	Average Gross Weight in Gram per Packing Unit Crystal (001)
3188			
3 mm	1,440	21.5	30.0
4 mm	1,440	47.6	56.0
5 mm	720	43.2	51.7
6 mm	360	35.7	44.1
7 mm	144	22.2	30.7
8 mm	144	33.2	41.7
3200			
8 mm	144	34.0	53.0
10 mm	72	26.1	44.6
12 mm	72	54.9	74.0
14 mm	72	77.2	100.7
16 mm	72	115.8	139.4
18 mm	48	117.2	199.5
3210			
10x7 mm	72	18.1	37.9
16x11 mm	72	66.3	86.3
24x17 mm	24	72.5	97.9
3223			
12x6 mm	48	13.1	34.2
18x9 mm	36	27.7	45.1
29x14.5 mm	24	74.28	101.3
3230			
12x7 mm	96	29.7	47.0
18x10.5 mm	72	70.5	90.7
23x13.8 mm	36	67	95
28x17 mm	24	72.1	97.5
34x20.4 mm	16	96	122
3240			
16 mm	72	108.5	132.1
22 mm	24	88.0	139.6
3252			
14x10 mm	36	29.59	50.19
20x14 mm	15	35.55	60.28
28x20 mm	10	67.65	88.78
3255			
18x6 mm	96	64.3	87.1
26x8.5 mm	48	87.6	125.6
3256			
14x8.5 mm	96	48.2	67.5
19x11.5 mm	96	104.5	140.1
27x16 mm	30	95.4	128.9
3265			
20x16 mm	72	113.5	138.4
26x21 mm	20	59.8	85.0
3270			
16 mm	72	96.4	120.0
22 mm	24	72.3	117.4

Article Size	Packing Unit = Minimum Order Quantity in Pieces	Average Net Weight in Gram per Packing Unit Crystal (001)	Average Gross Weight in Gram per Packing Unit Crystal (001)
3288			
8 mm	144	51.0	61.9
10 mm	72	53.9	80.3
12 mm	72	69.8	96.5
3700			
6 mm	720	50.6	61.4
8 mm	288	62.2	88.4
10 mm	288	114.5	141.0
12 mm	144	105.4	128.5
14 mm	144	170.5	197.2
3754			
5 mm	720	28.4	38.6
7 mm	144	14.6	24.8

Crystal Buttons

Summary

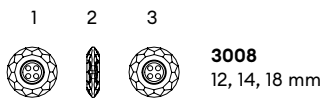

3008 Classic Crystal Button (4 holes)

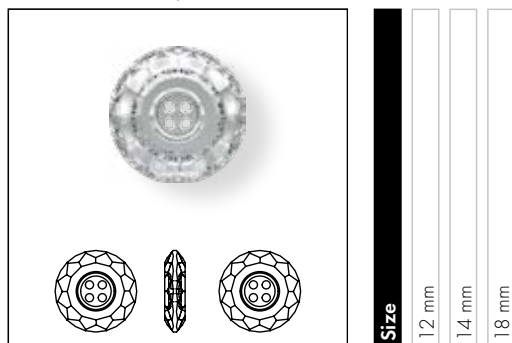

Size
12 mm
14 mm
18 mm

Crystal

Crystal F (001)

Colors

Plain Colors

Jet (280)

3015 Classic Rivoli Crystal Button

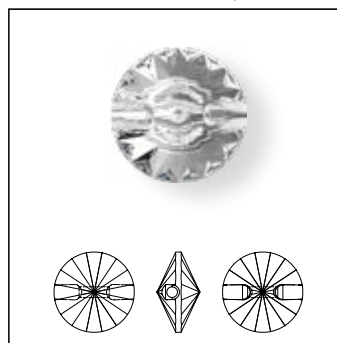

Size
10 mm
12 mm
14 mm
16 mm
18 mm
23 mm
27 mm

Crystal

Crystal F (001)

Colors

Plain Colors

Black Diamond F (215)

Jet (280)

Crystal Effects

Transparent Effects

Crystal Aurore Boreale F (001 AB)

Crystal Golden Shadow F (001 GSHA)

04

3019 Rivoli Crystal Button (2 holes)

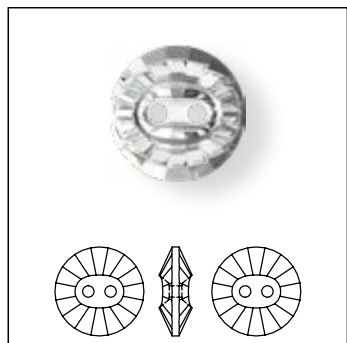

Size
12 mm
14 mm
16 mm

Crystal

Crystal F (001)

Colors

Plain Colors

Jet (280)

Product Details

Article Size	Packing Unit = Minimum Order Quantity in Pieces	Average Net Weight in Gram per Packing Unit Crystal (001)	Average Gross Weight in Gram per Packing Unit Crystal (001)
3008			
12 mm	48	29.9	50.8
14 mm	36	32.0	50.5
18 mm	24	52.3	72.0
3015			
10 mm	72	35.4	54.0
12 mm	48	41.4	59.9
14 mm	36	42.5	59.8
16 mm	24	47.6	64.9
18 mm	24	62.1	79.1
23 mm	8	42.9	64.9
27 mm	8	67.6	89.6
3019			
12 mm	48	31.2	51.3
14 mm	36	41.4	59.3
16 mm	24	39.8	62.5



Fancy Stones

Our Fancy Stones dazzle with brilliance and color, turning any design into a bold statement of style. Versatile and transformative the inspiring assortment of shapes and silhouettes – from timeless, gemstone-inspired cuts to the contemporary, and avant-garde – ensure individuality always shines through.

























Whether featuring a faceted or non-flat reverse side, each Fancy Stone becomes a canvas for self-expression. Able to be effortlessly applied with glue in pre-cast cavities or set into metal settings, their precision-cut facets ensure exceptional brilliance.











Rooted in heritage and elevated by innovation, our Fancy Stones empower designers to create everything from classic elegance to pop-infused luxury. This versatile collection reflects a dedication to cultural craftsmanship, technical mastery, and artistic freedom, offering endless possibilities to bring visionary designs to life.

Colors & Effects







Colors & Effects

Colors

-  Crystal 001
-  White Opal 234
-  Light Silk 261
-  Rosaline 508
-  Rose Water Opal 395
-  Vintage Rose 319
-  Light Rose 223
-  Rose Peach 262
-  Rose 209
-  Fuchsia 502
-  Light Siam 227
-  Scarlet 276
-  Siam 208
-  Amethyst 204
-  Iris 219
-  Light Amethyst 212
-  Violet 371
-  Tanzanite 539
-  Light Azore 361
-  Aquamarine 202
-  Light Sapphire 211
-  Sapphire 206
-  Montana 207
-  Denim Blue 266

-  Light Turquoise 263
-  Erinite 360
-  Chrysolite 238
-  Citrus Green 337
-  Majestic Green 336
-  Emerald 205
-  Jonquil 213
-  Light Topaz 226
-  Light Colorado Topaz 246
-  Black Diamond 215
-  Jet 280













Swarovski ReCreated™ Colors

-  ReCreated™ Ice Blue 1405
-  ReCreated™ Dark Sapphire 1404
-  ReCreated™ Peridot 1408
-  ReCreated™ Dark Jonquil 1407
-  ReCreated™ Light Smoked Topaz 1402
-  ReCreated™ Smoked Topaz 1403

TCF™ Colors



















-  Dark Rose 1201 TCF™
-  Dark Orange 1202 TCF™

Effects

-  Crystal Moonlight 001 MOL
-  Crystal Aurore Boreale 001 AB
-  Crystal Vitrail Light 001 VL
-  Crystal Paradise Shine 001 PARSH
-  Crystal Vitrail Medium 001 VM
-  Crystal Volcano 001 VOL
-  Crystal Bermuda Blue 001 BBL
-  Crystal Blue Shade 001 BLSH
-  Crystal Golden Shadow 001 GSHA
-  Crystal Aurum 001 AUR
-  Crystal Silver Shade 001 SSHA
-  Crystal Silver Night 001 SINI

Crystal Lacquer^{PRO} Effects







Crystal Lacquer^{PRO} Ignite Effects

-  Crystal Linen Ignite
001 L164L
-  Crystal Soft Rose Ignite
001 L167I
-  Crystal Flamingo Ignite
001 L162I
-  Crystal Dahlia Ignite
001 L177I
-  Crystal Orange Ignite
001 L159I
-  Crystal Maroon Ignite
001 L160I
-  Crystal Poppy Red Ignite
001 L179I
-  Crystal Orchid Ignite
001 L171I
-  Crystal Purple Ignite
001 L161I
-  Crystal Sky Ignite
001 L163I
-  Crystal Denim Ignite
001 L166I
-  Crystal Teal Ignite
001 L178I
-  Crystal Pine Green Ignite
001 L170I
-  Crystal Agave Ignite
001 L165I
-  Crystal Soft Mint Ignite
001 L168I
-  Crystal Soft Yellow Ignite
001 L169I
-  Crystal Mango Ignite
001 L152I
-  Crystal Dark Grey Ignite
001 L111I

Crystal Electric Lacquer^{PRO} Ignite Effects

-  Crystal Electric White Ignite
001 L139I
-  Crystal Electric Orange Ignite
001 L136I
-  Crystal Electric Pink Ignite
001 L137I
-  Crystal Electric Violet Ignite
001 L148I
-  Crystal Electric Blue Ignite
001 L134I
-  Crystal Electric Green Ignite
001 L135I
-  Crystal Electric Yellow Ignite
001 L138I

Ignite Effects

-  Crystal Ignite
001 IGNIT
-  Light Rose Ignite
223 IGNIT
-  Scarlet Ignite
276 IGNIT
-  Amethyst Ignite
204 IGNIT
-  Aquamarine Ignite
202 IGNIT
-  Emerald Ignite
205 IGNIT
-  Light Colorado Topaz Ignite
246 IGNIT

05

Shimmer Effects

-  Light Topaz Shimmer
226 SHIM

Numerical Order

001	Crystal	001 L1781	Crystal Teal Ignite	238	Chrysolite
001 AB	Crystal Aurore Boreale	001 L1791	Crystal Poppy Red Ignite	246 IGNIT	Light Colorado Topaz Ignite
001 AUR	Crystal Aurum	001 MOL	Crystal Moonlight	246	Light Colorado Topaz
001 BBL	Crystal Bermuda Blue	001 PARSH	Crystal Paradise Shine	261	Light Silk
001 BLSH	Crystal Blue Shade	001 SINI	Crystal Silver Night	262	Rose Peach
001 GSHA	Crystal Golden Shadow	001 SSHA	Crystal Silver Shade	263	Light Turquoise
001 IGNIT	Crystal Ignite	001 VL	Crystal Vitrail Light	266	Denim Blue
001 L1111	Crystal Dark Grey Ignite	001 VM	Crystal Vitrail Medium	276 IGNIT	Scarlet Ignite
001 L1341	Crystal Electric Blue Ignite	001 VOL	Crystal Volcano	276	Scarlet
001 L1351	Crystal Electric Green Ignite	202 IGNIT	Aquamarine Ignite	280	Jet
001 L1361	Crystal Electric Orange Ignite	202	Aquamarine	319	Vintage Rose
001 L1371	Crystal Electric Pink Ignite	204 IGNIT	Amethyst Ignite	336	Majestic Green
001 L1381	Crystal Electric Yellow Ignite	204	Amethyst	337	Citrus Green
001 L1391	Crystal Electric White Ignite	205 IGNIT	Emerald Ignite	360	Erinite
001 L1481	Crystal Electric Violet Ignite	205	Emerald	361	Light Azore
001 L1521	Crystal Mango Ignite	206	Sapphire	371	Violet
001 L1591	Crystal Orange Ignite	207	Montana	395	Rose Water Opal
001 L1601	Crystal Maroon Ignite	208	Siam	502	Fuchsia
001 L1611	Crystal Purple Ignite	209	Rose	508	Rosaline
001 L1621	Crystal Flamingo Ignite	211	Light Sapphire	539	Tanzanite
001 L1631	Crystal Sky Ignite	212	Light Amethyst	1201 TCF™	Dark Rose
001 L1641	Crystal Linen Ignite	213	Jonquil	1202 TCF™	Dark Orange
001 L1651	Crystal Agave Ignite	215	Black Diamond	1402	ReCreated™ Light Smoked Topaz
001 L1661	Crystal Denim Ignite	219	Iris	1403	ReCreated™ Smoked Topaz
001 L1671	Crystal Soft Rose Ignite	223 IGNIT	Light Rose Ignite	1404	ReCreated™ Dark Sapphire
001 L1681	Crystal Soft Mint Ignite	223	Light Rose	1405	ReCreated™ Ice Blue
001 L1691	Crystal Soft Yellow Ignite	226 SHIM	Light Topaz Shimmer	1407	ReCreated™ Dark Jonquil
001 L1701	Crystal Pine Green Ignite	226	Light Topaz	1408	ReCreated™ Peridot
001 L1711	Crystal Orchid Ignite	227	Light Siam		
001 L1771	Crystal Dahlia Ignite	234	White Opal		

Alphabetical Order

Amethyst (204)	Crystal Orange Ignite (001 L1591)	Light Rose (223)
Amethyst Ignite (204 IGNIT)	Crystal Orchid Ignite (001 L1711)	Light Rose Ignite (223 IGNIT)
Aquamarine (202)	Crystal Paradise Shine (001 PARSH)	Light Sapphire (211)
Aquamarine Ignite (202 IGNIT)	Crystal Pine Green Ignite (001 L1701)	Light Siam (227)
Black Diamond (215)	Crystal Poppy Red Ignite (001 L1791)	Light Silk (261)
Chrysolite (238)	Crystal Purple Ignite (001 L1611)	Light Topaz (226)
Citrus Green (337)	Crystal Silver Night (001 SINI)	Light Topaz Shimmer (226 SHIM)
Crystal (001)	Crystal Silver Shade (001 SSHA)	Light Turquoise (263)
Crystal Agave Ignite (001 L1651)	Crystal Sky Ignite (001 L1631)	Majestic Green (336)
Crystal Aurore Boreale (001 AB)	Crystal Soft Mint Ignite (001 L1681)	Montana (207)
Crystal Aurum (001 AUR)	Crystal Soft Rose Ignite (001 L1671)	ReCreated™ Dark Jonquil (1407)
Crystal Bermuda Blue (001 BBL)	Crystal Soft Yellow Ignite (001 L1691)	ReCreated™ Dark Sapphire (1404)
Crystal Blue Shade (001 BLSH)	Crystal Teal Ignite (001 L1781)	ReCreated™ Ice Blue (1405)
Crystal Dahlia Ignite (001 L1771)	Crystal Vitrail Light (001 VL)	ReCreated™ Light Smoked Topaz (1402)
Crystal Dark Grey Ignite (001 L1111)	Crystal Vitrail Medium (001 VM)	ReCreated™ Peridot (1408)
Crystal Denim Ignite (001 L1661)	Crystal Volcano (001 VOL)	ReCreated™ Smoked Topaz (1403)
Crystal Electric Blue Ignite (001 L1341)	Dark Orange (1202 TCF™)	Rosaline (508)
Crystal Electric Green Ignite (001 L1351)	Dark Rose (1201 TCF™)	Rose (209)
Crystal Electric Orange Ignite (001 L1361)	Denim Blue (266)	Rose Peach (262)
Crystal Electric Pink Ignite (001 L1371)	Emerald (205)	Rose Water Opal (395)
Crystal Electric Violet Ignite (001 L1481)	Emerald Ignite (205 IGNIT)	Sapphire (206)
Crystal Electric White Ignite (001 L1391)	Erinite (360)	Scarlet (276)
Crystal Electric Yellow Ignite (001 L1381)	Fuchsia (502)	Scarlet Ignite (276 IGNIT)
Crystal Flamingo Ignite (001 L1621)	Iris (219)	Siam (208)
Crystal Golden Shadow (001 GSHA)	Jet (280)	Tanzanite (539)
Crystal Ignite (001 IGNIT)	Jonquil (213)	Vintage Rose (319)
Crystal Linen Ignite (001 L1641)	Light Amethyst (212)	Violet (371)
Crystal Mango Ignite (001 L1521)	Light Azore (361)	White Opal (234)
Crystal Maroon Ignite (001 L1601)	Light Colorado Topaz (246)	
Crystal Moonlight (001 MOL)	Light Colorado Topaz Ignite (246 IGNIT)	

For details on available colors and effects for each article within the product groups, please see the product matrix of the respective item in the Collection 2026.

The plating resistance of effects is tested according to Swarovski's plating guidelines (SWAROVSKI.COM/S-PROFESSIONALS). Customers are advised to carry out their own tests if their plating parameters diverge from Swarovski plating guidelines.

Colors and effects can appear different when illuminated with different light sources. Swarovski uses standard light source D65 for color decision and comparison. Slight changes in shades are unavoidable. Colors may vary according to cut and foiling.

The composition of Advanced Crystal is compliant with regulatory industry norms and laws regarding the restriction or prohibition of certain substances in the most relevant segments of our customers. Please note that the compliance of the colors Light Siam and Siam varies according to certain industry regulations. Those regulations are indicated with * in the compliance overview. Indian Siam, Ruby and Scarlet (option to Lt. Siam) conform to all CLEAR-lists. For further information please visit swarovski.com/s-professionals

© 2026 D. Swarovski Distribution GmbH

Summary

1 2 3  4120 6x4, 8x6, 14x10, 18x13 mm	1 2 3  4327 30x20 mm	1 2 3  4487 27 mm
 4127 30x22 mm	 4328 6x3.6, 8x4.8 mm	 4500 3x2, 6x2 mm
 4128 6x4, 8x6 mm	 4329 8x7, 10x8.7, 14x12.1 mm	 4501 4x2, 5x2, 5x2.5, 7x3 mm
 4139 14, 20 mm	 4390 10x7, 14x10, 18x13 mm	 4502 3x1 mm
 4160 8x6, 10x8, 14x10, 18x13 mm	 4428 1.5, 2, 3, 4, 8 mm	 4527 8x6, 14x10, 18x13 mm
 4161 15x5 mm	 4447 6, 8, 10, 12 mm	 4547 15x5, 21x7 mm
 4162 10x5.5, 14x7.5, 18x9.5 mm	 4460 8, 10, 14, 18 mm	 4568 14x10, 18x13 mm
 4200 11x3, 15x4 mm	 4470 10, 12 mm	 4600 6x4, 8x6, 10x8 mm
 4228 4x2, 5x2.5, 6x3, 8x4, 10x5, 15x7 mm	 4471 8, 10, 12 mm	 4610 14x10, 18x13 mm
 4320 6x4, 8x6, 10x7, 14x10, 18x13 mm	 4480 6, 8, 10, 14, 18 mm	 4627 27x18.5 mm
 4322 10x5 mm	 4483 8, 10, 12, 14 mm	 4683 7.8x8.7, 10x11.2, 12x13.5, 14x15.8 mm

1 2 3



4706
7, 12, 17 mm



4722
4, 6 mm



4744
6, 10 mm



4745
5, 10 mm



4809
8x7.5, 13x12
17x15.5 mm



4815
6x5.3, 10x8.8 mm



4841
4, 6, 8 mm

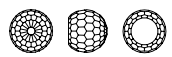

4869
4, 6, 8 mm



4884
5.5x5, 6.6x6,
8.8x8, 11x10 mm

Summary

1 Top view 2 Side view 3 Back view

4120 Oval Fancy Stone

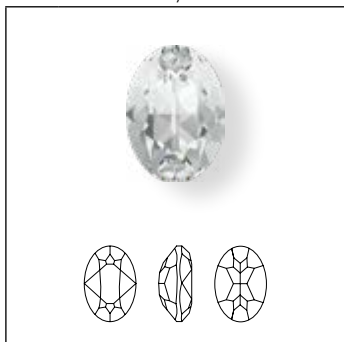

Size 6x4, 8x6, 14x10, 18x13 mm

4127 Big Oval Fancy Stone

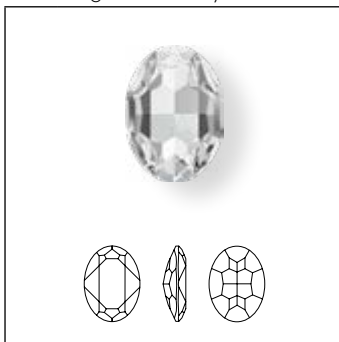

Size 30x22 mm

	4120 Oval Fancy Stone				4127 Big Oval Fancy Stone
	6x4 mm	8x6 mm	14x10 mm	18x13 mm	30x22 mm
Crystal					
Crystal F (001)	■	■	■	■	■
Colors					
Plain Colors					
Amethyst F (204)	■	■	■	■	■
Aquamarine F (202)	■	■	■	■	■
Black Diamond F (215)	■	■	■	■	■
Chrysolite F (238)	■	■	■	■	■
Citrus Green F (337)	■	■	■	■	■
Denim Blue F (266)	■	■	■	■	■
Emerald F (205)	■	■	■	■	■
Jet (280)	■	■	■	■	■
Light Amethyst F (212)	■	■	■	■	■
Light Azore F (361)	■	■	■	■	■
Light Colorado Topaz F (246)	■	■	■	■	■
Light Rose F (223)	■	■	■	■	■
Light Topaz F (226)	■	■	■	■	■
Light Turquoise F (263)	■	■	■	■	■
Majestic Green F (336)	■	■	■	■	■
Montana F (207)	■	■	■	■	■
Rose F (209)	■	■	■	■	■
Rose Peach F (262)	■	■	■	■	■
Sapphire F (206)	■	■	■	■	■
Scarlet F (276)	■	■	■	■	■
Siam F (208)	■	■	■	■	■
Tanzanite F (539)	■	■	■	■	■
Vintage Rose F (319)	■	■	■	■	■

4120 4127		Size	4120 Oval Fancy Stone	6x4 mm	8x6 mm	14x10 mm	18x13 mm	4127 Big Oval Fancy Stone	30x22 mm
Opal Colors									
White Opal F (234)									
Swarovski ReCreated™ Colors									
ReCreated™ Dark Jonquil F (1407)									
ReCreated™ Dark Sapphire F (1404)									
ReCreated™ Ice Blue F (1405)									
ReCreated™ Light Smoked Topaz F (1402)									
ReCreated™ Peridot F (1408)									
ReCreated™ Smoked Topaz F (1403)									
TCF™ Colors									
Dark Orange F (1202 TCF™)									
Dark Rose F (1201 TCF™)									
Crystal Effects									
Transparent Effects									
Crystal Aurore Boreale F (001 AB)									
Crystal Golden Shadow F (001 GSHA)									
Crystal Ignite (001 IGNIT)									
Crystal Moonlight F (001 MOL)									
Crystal Silver Night F (001 SINI)									
Crystal Silver Shade F (001 SSHA)									
Metallic Effects									
Crystal Aurum F (001 AUR)									
Crystal Lacquer^{PRO} Effects									
Crystal Lacquer^{PRO} Ignite Effects									
Crystal Agave Ignite (001 L1651)									
Crystal Dahlia Ignite (001 L1771)									
Crystal Dark Grey Ignite (001 L1111)									
Crystal Denim Ignite (001 L1661)									
Crystal Flamingo Ignite (001 L1621)									
Crystal Linen Ignite (001 L1641)									
Crystal Mango Ignite (001 L1521)									
Crystal Maroon Ignite (001 L1601)									
Crystal Orange Ignite (001 L1591)									
Crystal Orchid Ignite (001 L1711)									
Crystal Pine Green Ignite (001 L1701)									
Crystal Poppy Red Ignite (001 L1791)									

4120 4127		Size	4120 Oval Fancy Stone	6x4 mm	8x6 mm	14x10 mm	18x13 mm	4127 Big Oval Fancy Stone	30x22 mm
Crystal Purple Ignite (001 L1611)						■	■		■
Crystal Sky Ignite (001 L1631)						■	■		■
Crystal Soft Mint Ignite (001 L1681)						■	■		■
Crystal Soft Rose Ignite (001 L1671)						■	■		■
Crystal Soft Yellow Ignite (001 L1691)						■	■		■
Crystal Teal Ignite (001 L1781)						■	■		■
Crystal Electric Lacquer^{PRO} Ignite Effects									
Crystal Electric Blue Ignite (001 L1341)						■	■		■
Crystal Electric Green Ignite (001 L1351)						■	■		■
Crystal Electric Orange Ignite (001 L1361)						■	■		■
Crystal Electric Pink Ignite (001 L1371)						■	■		■
Crystal Electric Violet Ignite (001 L1481)						■	■		■
Crystal Electric White Ignite (001 L1391)						■	■		■
Crystal Electric Yellow Ignite (001 L1381)						■	■		■
Color Effects									
Transparent Effects									
Amethyst Ignite (204 IGNIT)						■	■		■
Aquamarine Ignite (202 IGNIT)						■	■		■
Emerald Ignite (205 IGNIT)						■	■		■
Light Colorado Topaz Ignite (246 IGNIT)						■	■		■
Light Rose Ignite (223 IGNIT)						■	■		■
Scarlet Ignite (276 IGNIT)						■	■		■

4128 XILION Oval Fancy Stone

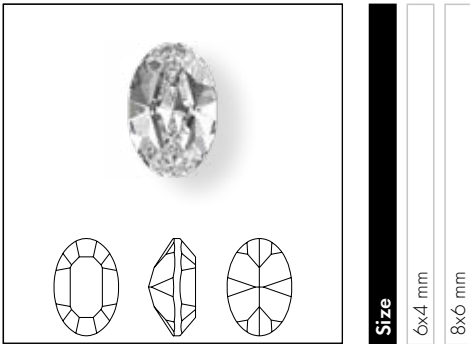

Crystal	
Crystal F (001)	<input type="checkbox"/>
Colors	
Plain Colors	
Amethyst F (204)	<input type="checkbox"/>
Aquamarine F (202)	<input type="checkbox"/>
Black Diamond F (215)	<input type="checkbox"/>
Emerald F (205)	<input type="checkbox"/>
Light Amethyst F (212)	<input type="checkbox"/>
Light Rose F (223)	<input type="checkbox"/>
Montana F (207)	<input type="checkbox"/>
Rose F (209)	<input type="checkbox"/>
Siam F (208)	<input type="checkbox"/>
Crystal Effects	
Transparent Effects	
Crystal Golden Shadow F (001 GSHA)	<input type="checkbox"/>

4139 Cosmic Ring Fancy Stone



Crystal	
Crystal (001)	<input type="checkbox"/>
Crystal Effects	
Transparent Effects	
Crystal Aurore Boreale (001 AB)	<input type="checkbox"/>
Crystal Bermuda Blue (001 BB)	<input type="checkbox"/>
Crystal Golden Shadow (001 GSHA)	<input type="checkbox"/>
Crystal Silver Night (001 SINI)	<input type="checkbox"/>
Crystal Vitrail Light (001 VL)	<input type="checkbox"/>
Crystal Vitrail Medium (001 VM)	<input type="checkbox"/>
Crystal Volcano (001 VOL)	<input type="checkbox"/>
Metallic Effects	
Crystal Comet Argent Light V SI (001 CAVSI)	<input type="checkbox"/>

4160 Mystic Oval Fancy Stone

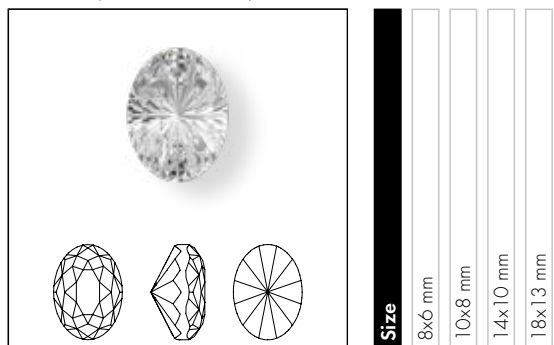

Size	8x6 mm	10x8 mm	14x10 mm	18x13 mm
-------------	--------	---------	----------	----------

Crystal				
Crystal F (001)	■	■	■	■
Crystal Effects				
Transparent Effects				
Crystal Aurore Boreale F (001 AB)	■	■	■	■
Crystal Paradise Shine F (001 PARSH)	■	■	■	■
Crystal Vitrail Medium F (001 VM)	■	■	■	■
Crystal Lacquer^{PRO} Ignite Effects				
Crystal Flamingo Ignite (001 L162I)	■	■	■	■
Crystal Linen Ignite (001 L164I)	■	■	■	■
Crystal Sky Ignite (001 L163I)	■	■	■	■

4161 Long Classic Oval Fancy Stone

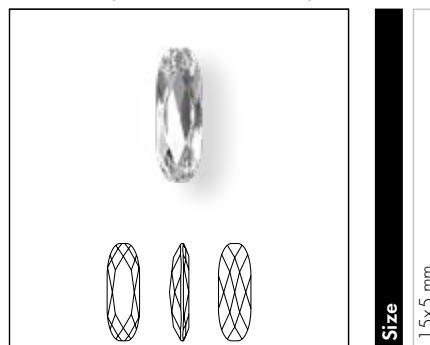

Size	1.5x5 mm
-------------	----------

Crystal	
Crystal F (001)	■

4162 Elongated Oval Fancy Stone

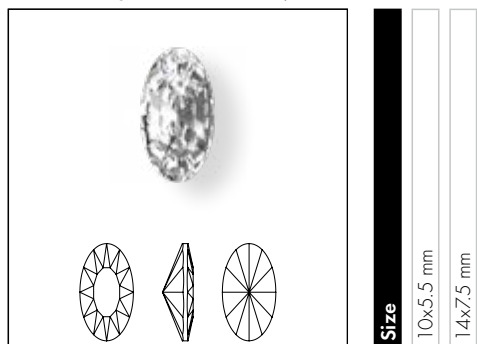

Size	10x5.5 mm	14x7.5 mm
-------------	-----------	-----------

Crystal		
Crystal F (001)	■	■
Crystal Effects		
Transparent Effects		
Crystal Aurore Boreale F (001 AB)	■	■
Crystal Golden Shadow F (001 GSHA)	■	■
Crystal Silver Shade F (001 SSHA)	■	■

4200 Sphinx Eye Fancy Stone

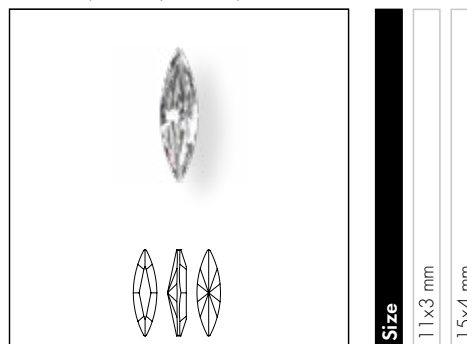

Size	11x3 mm	15x4 mm
-------------	---------	---------

Crystal		
Crystal F (001)	■	■
Crystal Effects		
Transparent Effects		
Crystal Aurore Boreale F (001 AB)	■	■
Crystal Golden Shadow F (001 GSHA)	■	■

4228 XILION Navette Fancy Stone

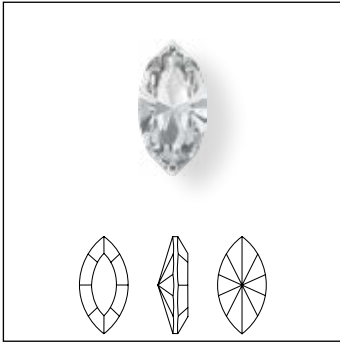

Size 4x2, 5x2.5 mm

4228 XILION Navette Fancy Stone

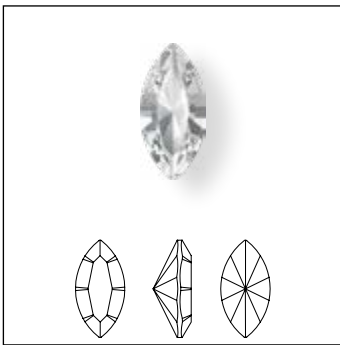

Size 6x3, 8x4, 10x5, 15x7 mm

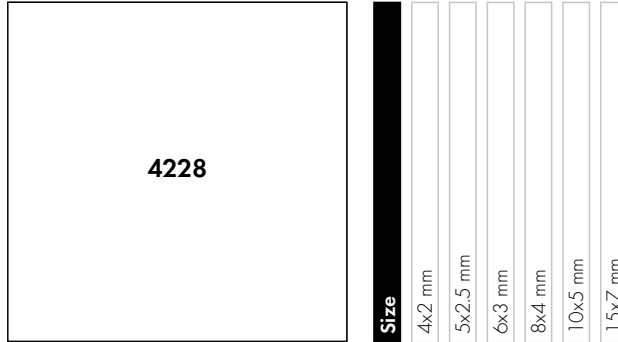

	4x2 mm	5x2.5 mm	6x3 mm	8x4 mm	10x5 mm	15x7 mm
Crystal						
Crystal F (001)	■	■	■	■	■	■
Colors						
Plain Colors						
Amethyst F (204)	■	■	■	■	■	■
Aquamarine F (202)	■	■	■	■	■	■
Black Diamond F (215)	■	■	■	■	■	■
Chrysolite F (238)	■	■	■	■	■	■
Citrus Green F (337)	■	■	■	■	■	■
Denim Blue F (266)	■	■	■	■	■	■
Emerald F (205)	■	■	■	■	■	■
Jet (280)	■	■	■	■	■	■
Light Amethyst F (212)	■	■	■	■	■	■
Light Colorado Topaz F (246)	■	■	■	■	■	■
Light Rose F (223)	■	■	■	■	■	■
Light Sapphire F (211)	■	■	■	■	■	■
Light Siam F (227)	■	■	■	■	■	■
Light Silk F (261)	■	■	■	■	■	■
Light Topaz F (226)	■	■	■	■	■	■
Light Turquoise F (263)	■	■	■	■	■	■
Majestic Green F (336)	■	■	■	■	■	■
Montana F (207)	■	■	■	■	■	■
Rose F (209)	■	■	■	■	■	■
Rose Peach F (262)	■	■	■	■	■	■
Sapphire F (206)	■	■	■	■	■	■
Scarlet F (276)	■	■	■	■	■	■
Siam F (208)	■	■	■	■	■	■
Tanzanite F (539)	■	■	■	■	■	■
Opal Colors						
White Opal F (234)	■	■	■	■	■	■
ReCreated™ Colors						
ReCreated™ Dark Jonquil F (1407)	■	■	■	■	■	■
ReCreated™ Dark Sapphire F (1404)	■	■	■	■	■	■
ReCreated™ Ice Blue F (1405)	■	■	■	■	■	■
ReCreated™ Light Smoked Topaz F (1402)	■	■	■	■	■	■
ReCreated™ Peridot F (1408)	■	■	■	■	■	■
ReCreated™ Smoked Topaz F (1403)	■	■	■	■	■	■

4228		Size	4x2 mm	5x2.5 mm	6x3 mm	8x4 mm	10x5 mm	15x7 mm
TCF™ Colors								
	Dark Orange F (1202 TCF™)		■	■	■	■	■	■
	Dark Rose F (1201 TCF™)		■	■	■	■	■	■
Crystal Effects								
Transparent Effects								
	Crystal Aurore Boreale F (001 AB)		■	■	■	■	■	■
	Crystal Golden Shadow F (001 GSHA)		■	■	■	■	■	■
	Crystal Moonlight F (001 MOL)		■	■	■	■	■	■
	Crystal Silver Night F (001 SINI)		■	■	■	■	■	■
	Crystal Silver Shade F (001 SSHA)		■	■	■	■	■	■
Metallic Effects								
	Crystal Aurum F (001 AUR)		■	■	■	■	■	■
Crystal Lacquer^{PRO} Effects								
Crystal Lacquer^{PRO} Ignite Effects								
	Crystal Dahlia Ignite (001 L1771)						■	
	Crystal Mango Ignite (001 L1521)						■	
	Crystal Maroon Ignite (001 L1601)						■	
	Crystal Orange Ignite (001 L1591)						■	
	Crystal Orchid Ignite (001 L1711)						■	
	Crystal Pine Green Ignite (001 L1701)						■	
	Crystal Poppy Red Ignite (001 L1791)						■	
	Crystal Purple Ignite (001 L1611)						■	
	Crystal Teal Ignite (001 L1781)						■	

4320 Pear Fancy Stone

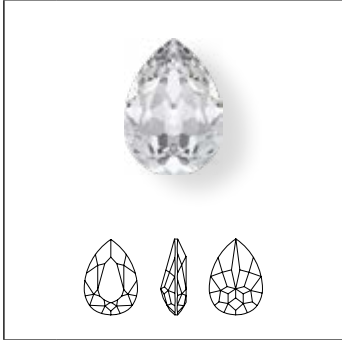

Size 6x4, 8x6, 10x7, 14x10, 18x13 mm

4327 Large Pear Fancy Stone



Size 30x20 mm

Crystal	Size	4320 Pear Fancy Stone	6x4 mm	8x6 mm	10x7 mm	14x10 mm	18x13 mm	4327 Large Pear Fancy Stone	30x20 mm
Crystal F (001)			■	■	■	■	■		■
Colors									
Plain Colors									
Amethyst F (204)			■	■	■	■	■		■
Aquamarine F (202)			■	■	■	■	■		■
Black Diamond F (215)			■	■	■	■	■		■
Chrysolite F (238)			■	■	■	■	■		■
Citrus Green F (337)			■	■	■	■	■		■
Denim Blue F (266)			■	■	■	■	■		■
Emerald F (205)			■	■	■	■	■		■
Iris F (219)			■	■	■	■	■		■
Jet (280)			■	■	■	■	■		■
Light Amethyst F (212)			■	■	■	■	■		■
Light Colorado Topaz F (246)			■	■	■	■	■		■
Light Rose F (223)			■	■	■	■	■		■
Light Silk F (261)			■	■	■	■	■		■
Light Topaz F (226)			■	■	■	■	■		■
Light Turquoise F (263)			■	■	■	■	■		■
Majestic Green F (336)			■	■	■	■	■		■
Montana F (207)			■	■	■	■	■		■
Rose F (209)			■	■	■	■	■		■
Rose Peach F (262)			■	■	■	■	■		■
Sapphire F (206)			■	■	■	■	■		■

	Size						
	4320 Pear Fancy Stone	6x4 mm	8x6 mm	10x7 mm	14x10 mm	18x13 mm	4327 Large Pear Fancy Stone
Scarlet F (276)	■	■	■	■	■		
Siam F (208)	■	■	■	■	■		
Tanzanite F (539)	■	■	■	■	■		■
Vintage Rose F (319)	■	■	■	■	■		
Opal Colors							
White Opal F (234)	■	■	■	■	■		■
Swarovski ReCreated™ Colors							
ReCreated™ Dark Jonquil F (1407)	■	■	■	■	■		
ReCreated™ Dark Sapphire F (1404)	■	■	■	■	■		
ReCreated™ Ice Blue F (1405)	■	■	■	■	■		
ReCreated™ Light Smoked Topaz F (1402)	■	■	■	■	■		
ReCreated™ Peridot F (1408)	■	■	■	■	■		■
ReCreated™ Smoked Topaz F (1403)	■	■	■	■	■		
TCF™ Colors							
Dark Orange F (1202 TCF™)	■	■	■	■	■		■
Dark Rose F (1201 TCF™)	■	■	■	■	■		■
Crystal Effects							
Transparent Effects							
Crystal Aurore Boreale F (001 AB)	■	■	■	■	■		■
Crystal Golden Shadow F (001 GSHA)	■	■	■	■	■		■
Crystal Ignite (001 IGNIT)		■	■	■	■		
Crystal Moonlight F (001 MOL)	■	■	■	■	■		
Crystal Silver Night F (001 SINI)	■	■	■	■	■		
Crystal Silver Shade F (001 SSHA)	■	■	■	■	■		■
Metallic Effects							
Crystal Aurum F (001 AUR)	■	■	■	■	■		
Crystal Lacquer^{PRO} Effects							
Crystal Lacquer^{PRO} Ignite Effects							
Crystal Agave Ignite (001 L1651)				■	■		■
Crystal Dahlia Ignite (001 L1771)				■	■		■
Crystal Dark Grey Ignite (001 L1111)				■	■		■
Crystal Denim Ignite (001 L1661)				■	■		■
Crystal Flamingo Ignite (001 L1621)				■	■		■
Crystal Linen Ignite (001 L1641)				■	■		■
Crystal Mango Ignite (001 L1521)				■	■		■
Crystal Maroon Ignite (001 L1601)				■	■		■
Crystal Orange Ignite (001 L1591)				■	■		■

4320
4327

4320 4327		Size	4320 Pear Fancy Stone	6x4 mm	8x6 mm	10x7 mm	14x10 mm	18x13 mm	4327 Large Pear Fancy Stone	30x20 mm
	Crystal Orchid Ignite (001 L1711)						■	■		■
	Crystal Pine Green Ignite (001 L1701)						■	■		■
	Crystal Poppy Red Ignite (001 L1791)						■	■		■
	Crystal Purple Ignite (001 L1611)						■	■		■
	Crystal Sky Ignite (001 L1631)						■	■		■
	Crystal Soft Mint Ignite (001 L1681)						■	■		■
	Crystal Soft Rose Ignite (001 L1671)						■	■		■
	Crystal Soft Yellow Ignite (001 L1691)						■	■		■
	Crystal Teal Ignite (001 L1781)						■	■		■
Crystal Electric Lacquer^{PRO} Ignite Effects										
	Crystal Electric Blue Ignite (001 L1341)						■	■		■
	Crystal Electric Green Ignite (001 L1351)						■	■		■
	Crystal Electric Orange Ignite (001 L1361)						■	■		■
	Crystal Electric Pink Ignite (001 L1371)						■	■		■
	Crystal Electric Violet Ignite (001 L1481)						■	■		■
	Crystal Electric White Ignite (001 L1391)						■	■		■
	Crystal Electric Yellow Ignite (001 L1381)						■	■		■

4322 Teardrop Fancy Stone

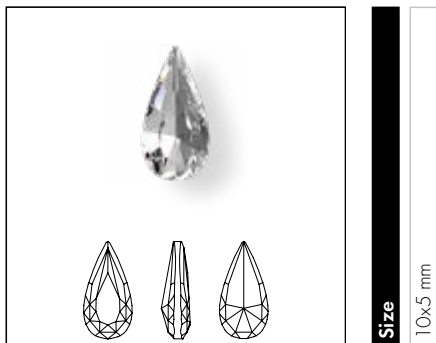

Size

10x5 mm

Crystal

Crystal F (001)

Crystal Effects

Transparent Effects

Crystal Aurore Boreale F (001 AB)

Crystal Golden Shadow F (001 GSHA)

Crystal Silver Shade F (001 SSHA)

4328 XILLION Pear Fancy Stone



Size

6x3.6 mm

8x4.8 mm

Crystal

Crystal F (001)

Colors

Plain Colors

Aquamarine F (202)

Black Diamond F (215)

Emerald F (205)

Light Rose F (223)

Siam F (208)

Crystal Effects

Transparent Effects

Crystal Golden Shadow F (001 GSHA)

4329 Majestic Fancy Stone

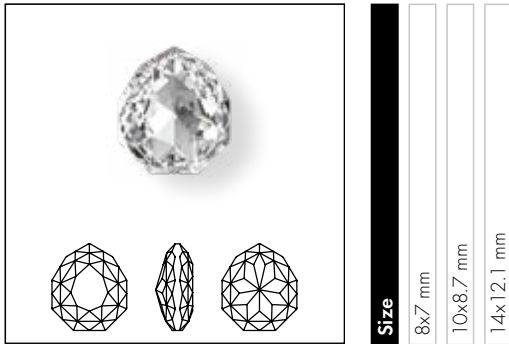

Size
8x7 mm
10x8.7 mm
14x12.1 mm

Crystal

Crystal F (001)

Colors

Plain Colors

- Amethyst F (204)
- Aquamarine F (202)
- Emerald F (205)
- Jonquil F (213)
- Light Rose F (223)
- Montana F (207)
- Scarlet F (276)

Crystal Effects

Transparent Effects

Crystal Golden Shadow F (001 GSHA)

4390 Mirage Pear Fancy Stone

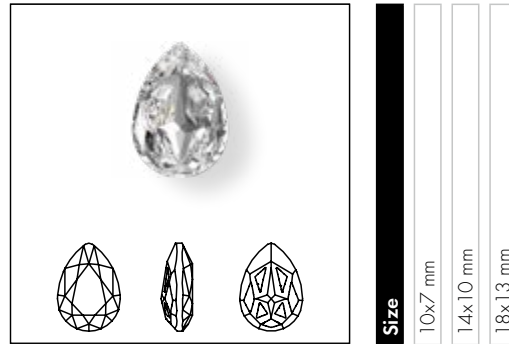

Size
10x7 mm
14x10 mm
18x13 mm

Crystal

Crystal F (001)

Colors

Plain Colors

- Amethyst F (204)
- Aquamarine F (202)
- Black Diamond F (215)
- Emerald F (205)
- Light Colorado Topaz F (246)
- Light Rose F (223)
- Montana F (207)
- Scarlet F (276)

Crystal Effects

Transparent Effects

- Crystal Aurore Boreale F (001 AB)
- Crystal Paradise Shine F (001 PARSH)
- Crystal Silver Night F (001 SINI)
- Crystal Vitrail Medium F (001 VM)

Crystal Lacquer^{PRO} Effects

Crystal Lacquer^{PRO} Ignite Effects

- Crystal Agave Ignite (001 L165I)
- Crystal Dahlia Ignite (001 L177I)
- Crystal Dark Grey Ignite (001 L111I)
- Crystal Denim Ignite (001 L166I)
- Crystal Mango Ignite (001 L152I)
- Crystal Orchid Ignite (001 L171I)
- Crystal Pine Green Ignite (001 L170I)
- Crystal Poppy Red Ignite (001 L179I)
- Crystal Teal Ignite (001 L178I)

4428 XILION Square Fancy Stone

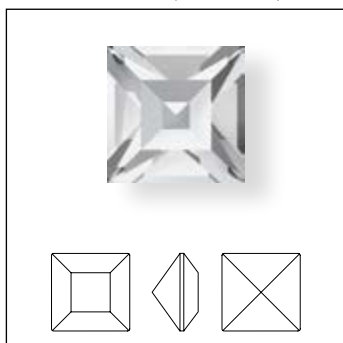

Size 1.5, 2 mm

4428 XILION Square Fancy Stone

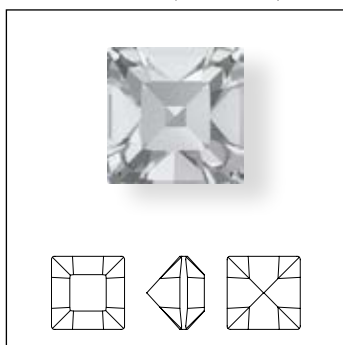

Size 3, 4 mm

4428 XILION Square Fancy Stone

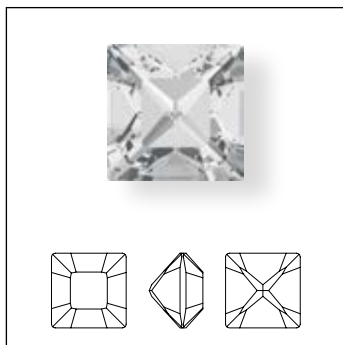

Size 8 mm

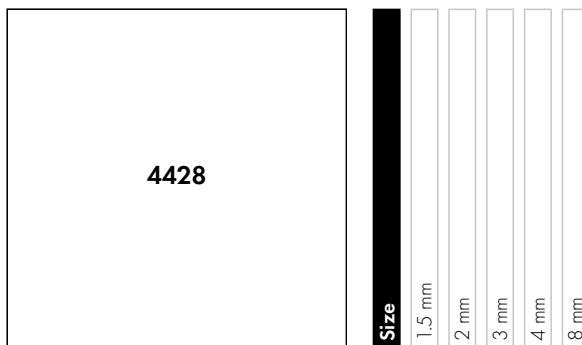

Crystal

Crystal F (001)

Colors

Plain Colors

Amethyst F (204)

Aquamarine F (202)

Black Diamond F (215)

Citrus Green F (337)

Emerald F (205)

Jet (280)

Jet F (280)

Light Amethyst F (212)

Light Colorado Topaz F (246)

Light Rose F (223)

Light Sapphire F (211)

Light Siam F (227)

Light Topaz F (226)

Light Turquoise F (263)

Majestic Green F (336)

Montana F (207)

Rose F (209)

Rose Peach F (262)

Sapphire F (206)

Scarlet F (276)

Siam F (208)

Tanzanite F (539)

ReCreated™ Colors

ReCreated™ Dark Jonquil F (1407)

ReCreated™ Dark Sapphire F (1404)

ReCreated™ Ice Blue F (1405)

ReCreated™ Light Smoked Topaz F (1402)





ReCreated™ Peridot F (1408)

ReCreated™ Smoked Topaz F (1403)

TCF™ Colors

Dark Orange F (1202 TCF™)

Dark Rose F (1201 TCF™)

4428		Size	1.5 mm	2 mm	3 mm	4 mm	8 mm
Crystal Effects							
Transparent Effects							
 Crystal Aurore Boreale F (001 AB)			■	■	■	■	
 Crystal Golden Shadow F (001 GSHA)			■	■	■	■	
 Crystal Silver Night F (001 SINI)			■	■	■	■	
 Crystal Silver Shade F (001 SSHA)			■	■	■	■	
Metallic Effects							
 Crystal Aurum F (001 AUR)			■	■	■	■	■

4447 Princess Square Fancy Stone



Size

6 mm 8 mm 10 mm 12 mm

Crystal

Crystal F (001)

4460 Mystic Square Fancy Stone



Size

8 mm 10 mm 14 mm 18 mm

Crystal

Crystal F (001)

Colors

Plain Colors

Amethyst F (204)

Aquamarine F (202)

Emerald F (205)

Iris F (219)

Light Colorado Topaz F (246)

Scarlet F (276)

Crystal Effects

Transparent Effects

Crystal Aurore Boreale F (001 AB)

Crystal Paradise Shine F (001 PARSH)

Crystal Vitrail Medium F (001 VM)

Crystal Lacquer^{PRO} Effects

Crystal Lacquer^{PRO} Ignite Effects

Crystal Flamingo Ignite (001 L162I)

Crystal Linen Ignite (001 L164I)

Crystal Maroon Ignite (001 L160I)

Crystal Orange Ignite (001 L159I)

Crystal Purple Ignite (001 L161I)

Crystal Sky Ignite (001 L163I)

Color Effects

Transparent Effects

Light Topaz Shimmer F (226 SHIM)

05

4470 Cushion Square Fancy Stone

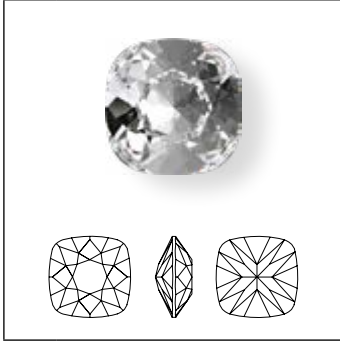

Size 10, 12 mm

4487 Large Cushion Square Fancy Stone

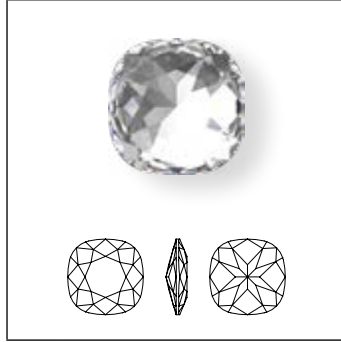

Size 27 mm

<p>4470 4487</p>	Size	4470 Cushion Square Fancy Stone	10 mm	12 mm	4487 Large Cushion Square F. S.	27 mm
------------------------------------	-------------	---------------------------------	-------	-------	---------------------------------	-------

Crystal	<input type="checkbox"/>	<input type="checkbox"/>	<input type="checkbox"/>
<input type="checkbox"/> Crystal F (001)	<input type="checkbox"/>	<input type="checkbox"/>	<input type="checkbox"/>
Colors			
Plain Colors			
<input type="checkbox"/> Amethyst F (204)	<input type="checkbox"/>	<input type="checkbox"/>	<input type="checkbox"/>
<input type="checkbox"/> Aquamarine F (202)	<input type="checkbox"/>	<input type="checkbox"/>	<input type="checkbox"/>
<input type="checkbox"/> Black Diamond F (215)	<input type="checkbox"/>	<input type="checkbox"/>	<input type="checkbox"/>
<input type="checkbox"/> Chrysolite F (238)	<input type="checkbox"/>	<input type="checkbox"/>	<input type="checkbox"/>
<input type="checkbox"/> Citrus Green F (337)	<input type="checkbox"/>	<input type="checkbox"/>	<input type="checkbox"/>
<input type="checkbox"/> Denim Blue F (266)	<input type="checkbox"/>	<input type="checkbox"/>	<input type="checkbox"/>
<input type="checkbox"/> Emerald F (205)	<input type="checkbox"/>	<input type="checkbox"/>	<input type="checkbox"/>
<input type="checkbox"/> Iris F (219)	<input type="checkbox"/>	<input type="checkbox"/>	<input type="checkbox"/>
<input type="checkbox"/> Jet (280)	<input type="checkbox"/>	<input type="checkbox"/>	<input type="checkbox"/>
<input type="checkbox"/> Light Amethyst F (212)	<input type="checkbox"/>	<input type="checkbox"/>	<input type="checkbox"/>
<input type="checkbox"/> Light Azore F (361)	<input type="checkbox"/>	<input type="checkbox"/>	<input type="checkbox"/>
<input type="checkbox"/> Light Colorado Topaz F (246)	<input type="checkbox"/>	<input type="checkbox"/>	<input type="checkbox"/>
<input type="checkbox"/> Light Rose F (223)	<input type="checkbox"/>	<input type="checkbox"/>	<input type="checkbox"/>
<input type="checkbox"/> Light Sapphire F (211)	<input type="checkbox"/>	<input type="checkbox"/>	<input type="checkbox"/>
<input type="checkbox"/> Light Siam F (227)	<input type="checkbox"/>	<input type="checkbox"/>	<input type="checkbox"/>
<input type="checkbox"/> Light Topaz F (226)	<input type="checkbox"/>	<input type="checkbox"/>	<input type="checkbox"/>
<input type="checkbox"/> Light Turquoise F (263)	<input type="checkbox"/>	<input type="checkbox"/>	<input type="checkbox"/>
<input type="checkbox"/> Majestic Green F (336)	<input type="checkbox"/>	<input type="checkbox"/>	<input type="checkbox"/>
<input type="checkbox"/> Rose Peach F (262)	<input type="checkbox"/>	<input type="checkbox"/>	<input type="checkbox"/>
<input type="checkbox"/> Sapphire F (206)	<input type="checkbox"/>	<input type="checkbox"/>	<input type="checkbox"/>
<input type="checkbox"/> Scarlet F (276)	<input type="checkbox"/>	<input type="checkbox"/>	<input type="checkbox"/>

<p>4470 4487</p>	Size	4470 Cushion Square Fancy Stone	10 mm	12 mm	4487 Large Cushion Square F. S.	27 mm
------------------------------------	-------------	---------------------------------	-------	-------	---------------------------------	-------

<input type="checkbox"/> Siam F (208)	<input type="checkbox"/>	<input type="checkbox"/>	<input type="checkbox"/>
<input type="checkbox"/> Tanzanite F (539)	<input type="checkbox"/>	<input type="checkbox"/>	<input type="checkbox"/>
<input type="checkbox"/> Vintage Rose F (319)	<input type="checkbox"/>	<input type="checkbox"/>	<input type="checkbox"/>
Opal Colors			
<input type="checkbox"/> White Opal F (234)	<input type="checkbox"/>	<input type="checkbox"/>	<input type="checkbox"/>
Swarovski ReCreated™ Colors			
<input type="checkbox"/> ReCreated™ Dark Jonquil F (1407)	<input type="checkbox"/>	<input type="checkbox"/>	<input type="checkbox"/>
<input type="checkbox"/> ReCreated™ Dark Sapphire F (1404)	<input type="checkbox"/>	<input type="checkbox"/>	<input type="checkbox"/>
<input type="checkbox"/> ReCreated™ Ice Blue F (1405)	<input type="checkbox"/>	<input type="checkbox"/>	<input type="checkbox"/>
<input type="checkbox"/> ReCreated™ Light Smoked Topaz F (1402)	<input type="checkbox"/>	<input type="checkbox"/>	<input type="checkbox"/>
<input type="checkbox"/> ReCreated™ Peridot F (1408)	<input type="checkbox"/>	<input type="checkbox"/>	<input type="checkbox"/>
<input type="checkbox"/> ReCreated™ Smoked Topaz F (1403)	<input type="checkbox"/>	<input type="checkbox"/>	<input type="checkbox"/>
TCF™ Colors			
<input type="checkbox"/> Dark Orange F (1202 TCF™)	<input type="checkbox"/>	<input type="checkbox"/>	<input type="checkbox"/>
<input type="checkbox"/> Dark Rose F (1201 TCF™)	<input type="checkbox"/>	<input type="checkbox"/>	<input type="checkbox"/>
Crystal Effects			
Transparent Effects			
<input type="checkbox"/> Crystal Aurore Boreale F (001 AB)	<input type="checkbox"/>	<input type="checkbox"/>	<input type="checkbox"/>
<input type="checkbox"/> Crystal Bermuda Blue F (001 BB)	<input type="checkbox"/>	<input type="checkbox"/>	<input type="checkbox"/>
<input type="checkbox"/> Crystal Golden Shadow F (001 GSHA)	<input type="checkbox"/>	<input type="checkbox"/>	<input type="checkbox"/>
<input type="checkbox"/> Crystal Ignite (001 IGNIT)	<input type="checkbox"/>	<input type="checkbox"/>	<input type="checkbox"/>
<input type="checkbox"/> Crystal Moonlight F (001 MOL)	<input type="checkbox"/>	<input type="checkbox"/>	<input type="checkbox"/>
<input type="checkbox"/> Crystal Silver Night F (001 SINI)	<input type="checkbox"/>	<input type="checkbox"/>	<input type="checkbox"/>
<input type="checkbox"/> Crystal Silver Shade F (001 SSHA)	<input type="checkbox"/>	<input type="checkbox"/>	<input type="checkbox"/>

<p>4470 4487</p>	Size	4470 Cushion Square Fancy Stone	10 mm	12 mm	4487 Large Cushion Square F. S.	27 mm
------------------------------------	-------------	--	-------	-------	--	-------

Metallic Effects

Crystal Aurum F (001 AUR)

Crystal Lacquer^{PRO} Effects

Crystal Lacquer^{PRO} Ignite Effects

Crystal Agave Ignite (001 L1651)

Crystal Dahlia Ignite (001 L1771)

Crystal Dark Grey Ignite (001 L1111)

Crystal Denim Ignite (001 L1661)

Crystal Flamingo Ignite (001 L1621)

Crystal Linen Ignite (001 L1641)

Crystal Mango Ignite (001 L1521)

Crystal Maroon Ignite (001 L1601)

Crystal Orange Ignite (001 L1591)

Crystal Orchid Ignite (001 L1711)

Crystal Pine Green Ignite (001 L1701)

Crystal Poppy Red Ignite (001 L1791)

Crystal Purple Ignite (001 L1611)

Crystal Sky Ignite (001 L1631)

Crystal Soft Mint Ignite (001 L1681)

Crystal Soft Rose Ignite (001 L1671)

Crystal Soft Yellow Ignite (001 L1691)

Crystal Teal Ignite (001 L1781)

Crystal Electric Lacquer^{PRO} Ignite Effects

Crystal Electric Blue Ignite (001 L1341)

Crystal Electric Green Ignite (001 L1351)

Crystal Electric Orange Ignite (001 L1361)

Crystal Electric Pink Ignite (001 L1371)

Crystal Electric Violet Ignite (001 L1481)

Crystal Electric White Ignite (001 L1391)

Crystal Electric Yellow Ignite (001 L1381)

Color Effects

Transparent Effects

Amethyst Ignite (204 IGNIT)

Aquamarine Ignite (202 IGNIT)

Emerald Ignite (205 IGNIT)

Light Colorado Topaz Ignite (246 IGNIT)

Light Rose Ignite (223 IGNIT)

Scarlet Ignite (276 IGNIT)

4471 Rose Cut Cushion Fancy Stone

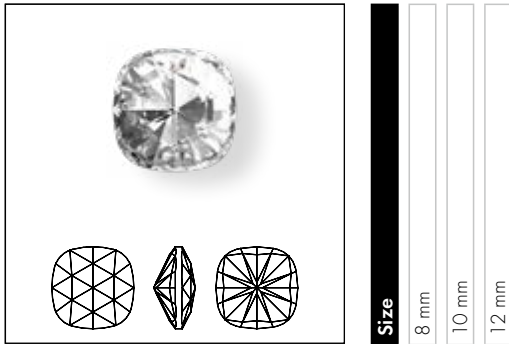

Size
8 mm
10 mm
12 mm

Crystal	8 mm	10 mm	12 mm
Crystal F (001)	■	■	■
Colors			
Plain Colors			
Vintage Rose F (319)	■	■	■
Opal Colors			
Rose Water Opal F (395)	■	■	■
White Opal F (234)	■	■	■
Crystal Effects			
Transparent Effects			
Crystal Aurore Boreale F (001 AB)	■	■	■
Crystal Golden Shadow F (001 GSHA)	■	■	■

4480 Imperial Fancy Stone

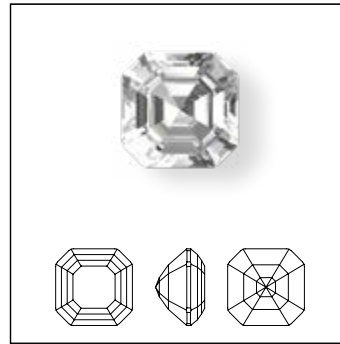

Size
6 mm
8 mm
10 mm
14 mm
18 mm

Crystal	6 mm	8 mm	10 mm	14 mm	18 mm
Crystal F (001)	■	■	■	■	■
Colors					
Plain Colors					
Amethyst F (204)	■	■	■	■	■
Aquamarine F (202)	■	■	■	■	■
Emerald F (205)	■	■	■	■	■
Jet (280)	■	■	■	■	■
Light Colorado Topaz F (246)	■	■	■	■	■
Light Rose F (223)	■	■	■	■	■
Montana F (207)	■	■	■	■	■
Scarlet F (276)	■	■	■	■	■
Crystal Effects					
Transparent Effects					
Crystal Aurore Boreale F (001 AB)	■	■	■	■	■
Crystal Golden Shadow F (001 GSHA)	■	■	■	■	■
Crystal Silver Night (001 SINI)	■	■	■	■	■
Crystal Silver Shade F (001 SSHA)	■	■	■	■	■

4483 Fantasy Cushion Fancy Stone

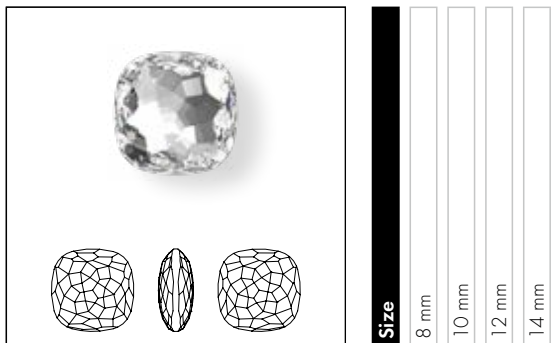

Size
8 mm
10 mm
12 mm
14 mm

Crystal

Crystal F (001)

Crystal Effects

Transparent Effects

Crystal Golden Shadow F (001 GSHA)

Crystal Silver Night (001 SINI)

Crystal Lacquer^{PRO} Effects

Crystal Lacquer^{PRO} Ignite Effects

Crystal Flamingo Ignite (001 L162I)

Crystal Linen Ignite (001 L164I)

Crystal Sky Ignite (001 L163I)

4500 Thin Baguette Fancy Stone

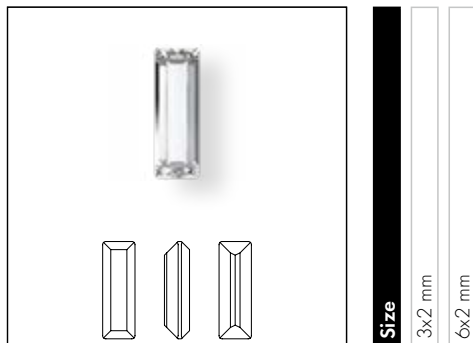

Size
3x2 mm
6x2 mm

Crystal

Crystal (001)

Crystal F (001)

4501 Baguette Fancy Stone

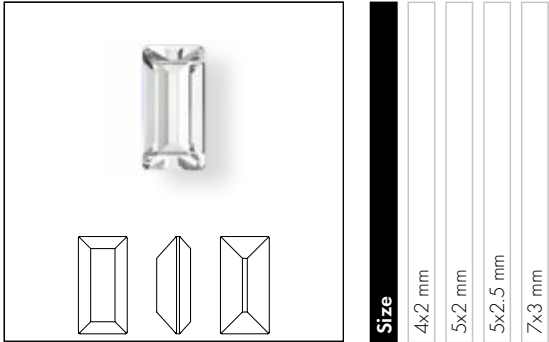

Crystal	4x2 mm	5x2 mm	5x2.5 mm	7x3 mm
Crystal F (001)				
Colors				
Plain Colors				
Amethyst F (204)				
Aquamarine F (202)				
Black Diamond F (215)				
Citrus Green F (337)				
Emerald F (205)				
Jet (280)				
Light Amethyst F (212)				
Light Colorado Topaz F (246)				
Light Rose F (223)				
Light Sapphire F (211)				
Light Topaz F (226)				
Light Turquoise F (263)				
Majestic Green F (336)				
Montana F (207)				
Rose F (209)				
Sapphire F (206)				
Scarlet F (276)				
Siam F (208)				
Tanzanite F (539)				
ReCreated™ Colors				
ReCreated™ Dark Jonquil F (1407)				
ReCreated™ Light Smoked Topaz F (1402)				
ReCreated™ Peridot F (1408)				
ReCreated™ Smoked Topaz F (1403)				
Crystal Effects				
Transparent Effects				
Crystal Aurore Boreale F (001 AB)				
Crystal Golden Shadow F (001 GSHA)				
Crystal Silver Night F (001 SINI)				
Crystal Silver Shade F (001 SSHA)				
Metallic Effects				
Crystal Aurum F (001 AUR)				

4502 Small Baguette Fancy Stone

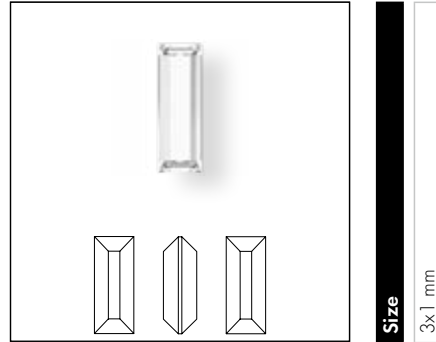

Crystal	3x1 mm
Crystal (001)	
Crystal F (001)	

4527 Step Cut Fancy Stone

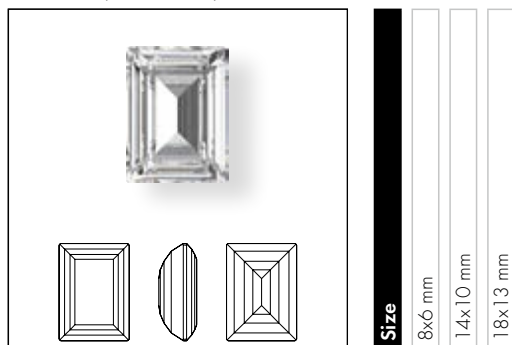

Size
8x6 mm
14x10 mm
18x13 mm

- Crystal**
- Crystal F (001)
- Colors**
- Plain Colors**
- Erinite F (360)
- Light Amethyst F (212)
- Montana F (207)
- Tanzanite F (539)
- ReCreated™ Colors**
- ReCreated™ Dark Sapphire F (1404)
- ReCreated™ Ice Blue F (1405)
- Crystal Effects**
- Transparent Effects**
- Crystal Golden Shadow F (001 GSHA)
- Crystal Moonlight F (001 MOL)

4547 Princess Baguette Fancy Stone

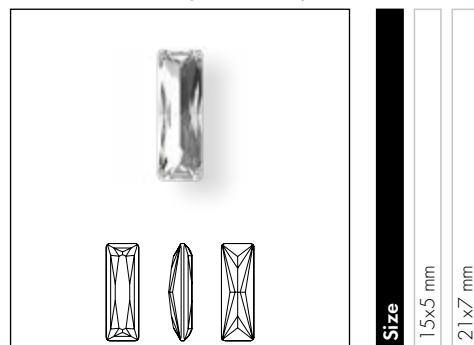

Size
15x5 mm
21x7 mm

- Crystal**
- Crystal F (001)

4568 Cushion Fancy Stone

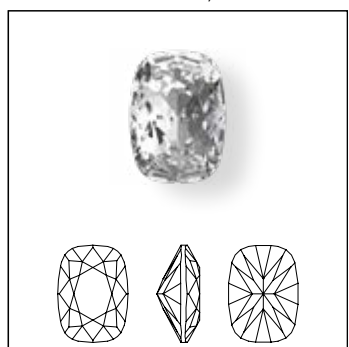

Size
14x10 mm
18x13 mm

- Crystal**
- Crystal F (001)
- Crystal Effects**
- Transparent Effects**
- Crystal Golden Shadow F (001 GSHA)
- Crystal Silver Night (001 SINI)
- Crystal Silver Shade F (001 SSHA)

4600 Octagon Fancy Stone



Size
6x4 mm
8x6 mm
10x8 mm

- Crystal**
- Crystal F (001)
- Crystal Effects**
- Transparent Effects**
- Crystal Golden Shadow F (001 GSHA)
- Crystal Silver Shade F (001 SSHA)

4610 Curved Back Octagon Fancy Stone

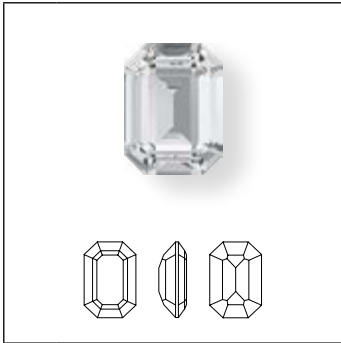

Size 14x10, 18x13 mm

4627 Thin Octagon Fancy Stone

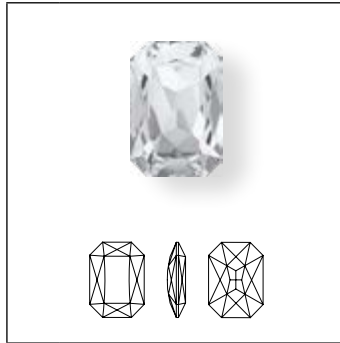

Size 27x18.5 mm

	4610 4627	Size	4610 Curved Back Octagon F. Stone	4627 Thin Octagon Fancy Stone
			14x10 mm	18x13 mm
				27x18.5 mm
Crystal				
Crystal F (001)			■	■
Colors				
Plain Colors				
Amethyst F (204)			■	■
Aquamarine F (202)			■	■
Black Diamond F (215)			■	■
Emerald F (205)			■	■
Jet (280)			■	■
Light Colorado Topaz F (246)			■	■
Majestic Green F (336)			■	■
Montana F (207)			■	■
Siam F (208)			■	■
Tanzanite F (539)			■	■
Swarovski ReCreated™ Colors				
ReCreated™ Dark Sapphire F (1404)			■	■
ReCreated™ Ice Blue F (1405)			■	■
ReCreated™ Peridot F (1408)			■	■
TCF™ Colors				
Dark Orange F (1202 TCF™)			■	■
Dark Rose F (1201 TCF™)			■	■

<p>4610 4627</p>	Size	4610 Curved Back Octagon F. Stone	14x10 mm	18x13 mm	4627 Thin Octagon Fancy Stone	27x18,5 mm
------------------------------------	-------------	--	----------	----------	--------------------------------------	------------

Crystal Effects

Transparent Effects

- Crystal Golden Shadow F (001 GSHA) ■ ■ ■
- Crystal Silver Shade F (001 SSHA) ■ ■ ■

Metallic Effects

- Crystal Aurum F (001 AUR) ■ ■

Crystal Lacquer^{PRO} Effects

Crystal Lacquer^{PRO} Ignite Effects

- Crystal Agave Ignite (001 L1651) ■
- Crystal Dahlia Ignite (001 L1771) ■
- Crystal Dark Grey Ignite (001 L1111) ■
- Crystal Denim Ignite (001 L1661) ■
- Crystal Flamingo Ignite (001 L1621) ■
- Crystal Linen Ignite (001 L1641) ■
- Crystal Mango Ignite (001 L1521) ■
- Crystal Orchid Ignite (001 L1711) ■
- Crystal Pine Green Ignite (001 L1701) ■
- Crystal Poppy Red Ignite (001 L1791) ■
- Crystal Sky Ignite (001 L1631) ■
- Crystal Soft Mint Ignite (001 L1681) ■
- Crystal Soft Rose Ignite (001 L1671) ■
- Crystal Soft Yellow Ignite (001 L1691) ■
- Crystal Teal Ignite (001 L1781) ■

Crystal Electric Lacquer^{PRO} Ignite Effects

- Crystal Electric Blue Ignite (001 L1341) ■
- Crystal Electric Green Ignite (001 L1351) ■
- Crystal Electric Orange Ignite (001 L1361) ■
- Crystal Electric Pink Ignite (001 L1371) ■
- Crystal Electric Violet Ignite (001 L1481) ■
- Crystal Electric White Ignite (001 L1391) ■
- Crystal Electric Yellow Ignite (001 L1381) ■

4683 Fantasy Hexagon Fancy Stone

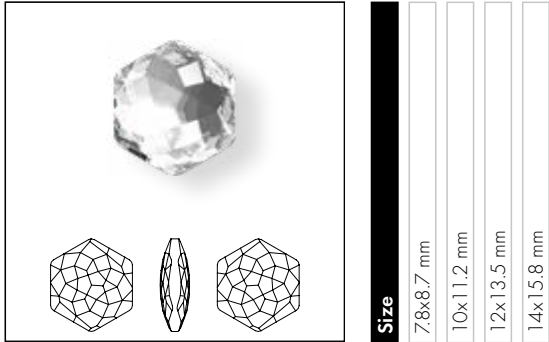

Size	7.8x8.7 mm	10x11.2 mm	12x13.5 mm	14x15.8 mm
-------------	------------	------------	------------	------------

Crystal				
Crystal F (001)	■	■	■	■
Colors				
Plain Colors				
Vintage Rose F (319)	■	■	■	■
Crystal Effects				
Transparent Effects				
Crystal Golden Shadow F (001 GSHA)	■	■	■	■
Crystal Silver Night (001 SINI)	■	■	■	■

4706 Trilliant Fancy Stone

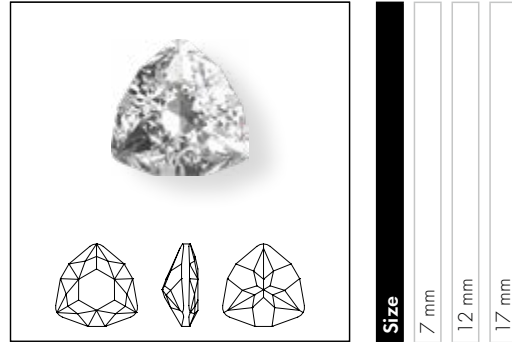

Size	7 mm	12 mm	17 mm
-------------	------	-------	-------

Crystal			
Crystal F (001)	■	■	■
Colors			
Plain Colors			
Amethyst F (204)	■	■	■
Aquamarine F (202)	■	■	■
Light Colorado Topaz F (246)	■	■	■
Rose F (209)	■	■	■
Scarlet F (276)	■	■	■
Tanzanite F (539)	■	■	■
Vintage Rose F (319)	■	■	■
Crystal Effects			
Transparent Effects			
Crystal Aurore Boreale F (001 AB)	■	■	■
Crystal Blue Shade F (001 BLSH)	■	■	■
Crystal Golden Shadow F (001 GSHA)	■	■	■
Crystal Silver Night (001 SINI)	■	■	■
Crystal Silver Shade F (001 SSHA)	■	■	■
Crystal Volcano F (001 VOL)	■	■	■
Metallic Effects			
Crystal Aurum F (001 AUR)	■	■	■

4722 Triangle Fancy Stone

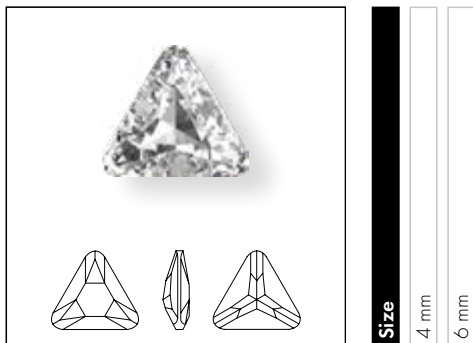

Size
4 mm
6 mm

Crystal

Crystal F (001)

4745 Rivoli Star Fancy Stone



Size
5 mm
10 mm

Crystal

Crystal F (001)

Colors

Plain Colors

Jet (280)

Crystal Effects

Transparent Effects

Crystal Aurore Boreale F (001 AB)

Crystal Bermuda Blue F (001 BB)

Crystal Golden Shadow F (001 GSHA)

Crystal Silver Shade F (001 SSHA)

Crystal Vitrail Light F (001 VL)

Crystal Vitrail Medium F (001 VM)

Metallic Effects

Crystal Aurum F (001 AUR)

4841 Cube Fancy Stone

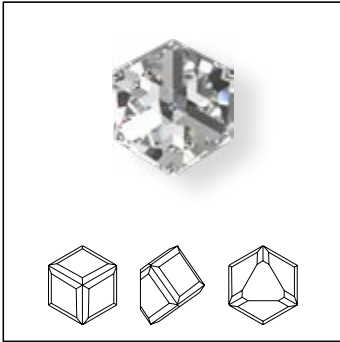

Size	4 mm	6 mm	8 mm
------	------	------	------

Crystal			
Crystal Comet Argent Light V Z (001 CAVZ)	■	■	■
Colors			
Plain Colors			
Aquamarine Comet Argent Light V Z (202 CAVZ)	■	■	■
Light Rose Comet Argent Light V Z (223 CAVZ)	■	■	■
Light Siam Comet Argent Light V Z (227 CAVZ)	■	■	■
Crystal Effects			
Transparent Effects			
Crystal Aurore Boreale CAL V Z (001 ABCVZ)	■	■	■
Crystal Bermuda Blue Z (001 BBZ)	■	■	■
Crystal Golden Shadow CAL V Z (001 GSCVZ)	■	■	■
Crystal Vitrail Light Z (001 VLZ)	■	■	■
Crystal Vitrail Medium Z (001 VMZ)	■	■	■

4869 Disco Fancy Stone

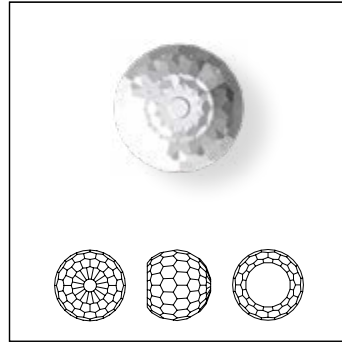

Size	4 mm	6 mm	8 mm
------	------	------	------

Crystal			
Crystal Comet Argent Light V Z (001 CAVZ)	■	■	■
Crystal Effects			
Transparent Effects			
Crystal Aurore Boreale CAL V Z (001 ABCVZ)	■	■	■
Crystal Vitrail Medium Z (001 VMZ)	■	■	■

4744 Rivoli Flower Fancy Stone

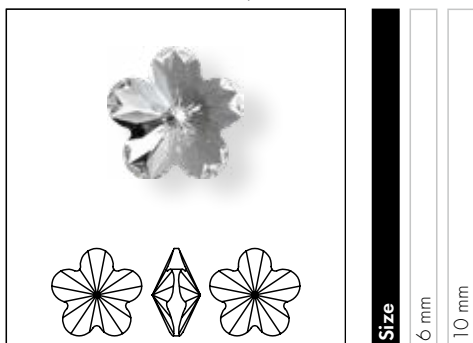

Crystal	
Crystal F (001)	■ ■
Colors	
Plain Colors	
Aquamarine F (202)	■ ■
Fuchsia F (502)	■ ■
Light Rose F (223)	■ ■
Violet F (371)	■ ■
ReCreated™ Colors	
ReCreated™ Dark Jonquil F (1407)	■ ■
Crystal Effects	
Transparent Effects	
Crystal Aurore Boreale F (001 AB)	■ ■

4809 Sweet Heart Fancy Stone

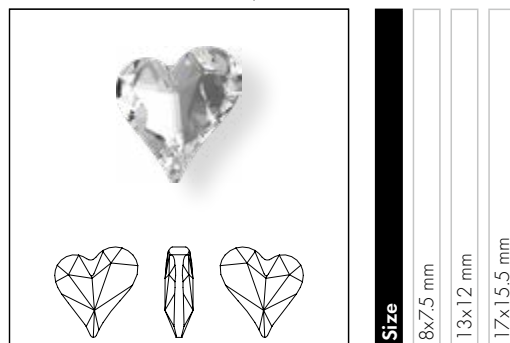

Crystal	
Crystal F (001)	■ ■ ■
Colors	
Plain Colors	
Amethyst F (204)	■ ■ ■
Light Siam F (227)	■ ■ ■
Rosaline F (508)	■ ■ ■
Rose F (209)	■ ■ ■
Rose Peach F (262)	■ ■ ■
Violet F (371)	■ ■ ■
TCF™ Colors	
Dark Rose F (1201 TCF™)	■ ■ ■
Crystal Effects	
Transparent Effects	
Crystal Aurore Boreale F (001 AB)	■ ■ ■
Crystal Blue Shade F (001 BLSH)	■ ■ ■
Crystal Golden Shadow F (001 GSHA)	■ ■ ■
Crystal Silver Night (001 SINI)	■ ■ ■
Crystal Lacquer ^{PRO} Effects	
Crystal Lacquer ^{PRO} Ignite Effects	
Crystal Soft Mint Ignite (001 L168I)	■ ■ ■
Crystal Soft Rose Ignite (001 L167I)	■ ■ ■
Crystal Soft Yellow Ignite (001 L169I)	■ ■ ■

05

4815 Forever Heart Fancy Stone

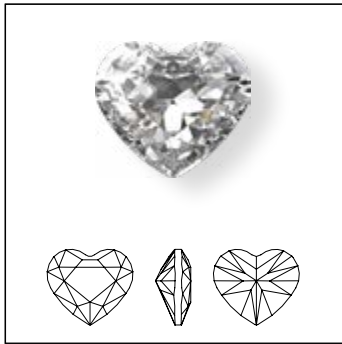

Size	6x5.3 mm	10x8.8 mm
-------------	----------	-----------

Crystal

Crystal F (001)

Colors

Plain Colors

Amethyst F (204)

Aquamarine F (202)

Light Rose F (223)

Light Siam F (227)

Majestic Green F (336)

ReCreated™ Colors

ReCreated™ Dark Jonquil F (1407)

ReCreated™ Dark Sapphire F (1404)

TCF™ Colors

Dark Rose F (1201 TCF™)

Crystal Effects

Transparent Effects

Crystal Aurore Boreale F (001 AB)

Crystal Golden Shadow F (001 GSHA)

Crystal Silver Night (001 SINI)

Crystal Silver Shade F (001 SSHA)

Metallic Effects

Crystal Aurum F (001 AUR)

4884 XILION Heart Fancy Stone

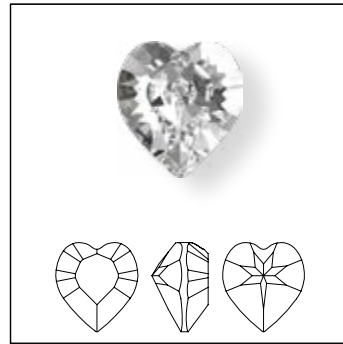

Size	5.5x5 mm	6.6x6 mm	8.8x8 mm	11x10 mm
-------------	----------	----------	----------	----------

Crystal

Crystal F (001)

Colors

Plain Colors

Aquamarine F (202)

Light Amethyst F (212)

Light Rose F (223)

Light Siam F (227)

Rose F (209)

ReCreated™ Colors

ReCreated™ Peridot F (1408)

Product Details

Article Size	Packing Unit = Minimum Order Quantity in Pieces	Average Net Weight in Gram per Packing Unit Crystal (001)	Average Gross Weight in Gram per Packing Unit Crystal (001)
4120			
6x4 mm	360	31.2	42.1
8x6 mm	180	44.7	45.2
14x10 mm	144	170.2	193.8
18x13 mm	48	112.3	132.9
4127			
30x22 mm	24	173.6	218.7
4128			
6x4 mm	360	26.8	37.6
8x6 mm	360	76.5	87.3
4139			
14 mm	72	53.2	82.7
20 mm	24	46.7	78.7
4160			
8x6 mm	90	23.9	43.5
10x8 mm	72	40.1	59.8
14x10 mm	48	65.9	85.6
18x13 mm	24	70.7	90.3
4161			
15x5 mm	72	29.5	51.6
4162			
10x5.5 mm	144	23.8	34.9
14x7.5 mm	72	36.0	56.4
18x9.5 mm	48	49.6	70.5
4200			
11x3 mm	360	28.6	39.4
15x4 mm	144	26.2	37.1
4228			
4x2 mm	720	9.2	18.3
5x2.5 mm	720	18.9	28.0
6x3 mm	720	30.5	39.6
8x4 mm	360	32.9	42.0
10x5 mm	360	60.7	72.1
15x7 mm	144	63.9	88.1
4320			
6x4 mm	360	25.7	34.8
8x6 mm	180	30.7	39.8
10x7 mm	144	48.6	68.9
14x10 mm	144	126.6	150.2
18x13 mm	48	85.2	105.8
4322			
10x5 mm	72	13.95	33.93
4327			
30x20 mm	24	161.8	206.8
4328			
6x3.6 mm	720	40.0	50.5
8x4.8 mm	360	42.1	53.0

Article Size	Packing Unit = Minimum Order Quantity in Pieces	Average Net Weight in Gram per Packing Unit Crystal (001)	Average Gross Weight in Gram per Packing Unit Crystal (001)
4329			
8x7 mm	90	23.9	45.3
10x8.7 mm	72	30.5	48.9
14x12.1 mm	24	26.5	47.2
4390			
10x7 mm	144	45.3	70.4
14x10 mm	144	125.4	150.9
18x13 mm	48	87.4	111.8
4428			
1.5 mm	1,440	4.32	15.1
2 mm	1,440	12.2	23.0
3 mm	1,440	34.8	57.6
4 mm	1,440	108.5	119.5
8 mm	144	84.5	99.6
4447			
6 mm	360	87.5	98.3
8 mm	144	71.5	91.9
10 mm	144	133.9	157.2
12 mm	72	117.6	137.9
4460			
8 mm	72	32.1	49.2
10 mm	48	41.1	58.8
14 mm	24	55.1	70.4
18 mm	15	70.5	88.7
4470			
10 mm	144	91.6	111.9
12 mm	72	74.7	92.9
4471			
8 mm	144	41.3	66.4
10 mm	96	54.3	77.5
12 mm	48	43.3	67.6
4480			
6 mm	288	50.02	73.28
8 mm	144	65.95	87.79
10 mm	96	86.30	110.13
14 mm	48	115.2	136.1
18 mm	15	75.0	92.9
4483			
8 mm	144	63.3	88.4
10 mm	96	77.76	104.6
12 mm	48	66.7	91.1
14 mm	24	53.0	72.8
4487			
27 mm	24	169.0	198.5
4500			
3x2 mm	1,440	20.5	32.0
6x2 mm	720	18.4	27.5

Article Size	Packing Unit = Minimum Order Quantity in Pieces	Average Net Weight in Gram per Packing Unit Crystal (001)	Average Gross Weight in Gram per Packing Unit Crystal (001)
4501			
4x2 mm	720	16.8	25.9
5x2 mm	720	18.1	27.2
5x2.5 mm	720	20.9	30.0
7x3 mm	720	60.2	71.1
4502			
3x1 mm	720	2.2	11.4
4527			
8x6 mm	144	53.7	64.6
14x10 mm	72	122.4	144.9
18x13 mm	72	246.9	270.6
4547			
15x5 mm	72	37.4	58.9
21x7 mm	48	65.3	98.7
4568			
14x10 mm	72	74.9	103.1
18x13 mm	24	46.2	64.7
4600			
6x4 mm	360	40.9	51.8
8x6 mm	144	41.2	52.2
10x8 mm	144	84.0	104.0
4610			
14x10 mm	144	171.3	194.9
18x13 mm	48	124.9	145.5
4627			
27x18.5 mm	24	125.3	170.8
4683			
7.8x8.7 mm	144	57.3	80.5
10x11.2 mm	96	75.8	99.4
12x13.5 mm	48	61.0	84.7
14x15.8 mm	24	46.4	67.0
4706			
7 mm	144	23.7	44.4
12 mm	72	61.5	83.9
17 mm	48	96.4	119.8
4722			
4 mm	480	12.0	21.1
6 mm	180	16.4	25.5
4744			
6 mm	720	62.3	72.8
10 mm	288	126.0	158.1
4745			
5 mm	720	35.6	46.4
10 mm	144	48.5	71.3

Article Size	Packing Unit = Minimum Order Quantity in Pieces	Average Net Weight in Gram per Packing Unit Crystal (001)	Average Gross Weight in Gram per Packing Unit Crystal (001)
4809			
8x7.5 mm	144	236.5	262.1
13x12 mm	72	47.8	68.5
17x15.5 mm	48	69.3	93.7
4815			
6x5.3 mm	288	27.1	50.3
10x8.8 mm	144	56.9	77.5
4841			
4 mm	288	45.3	66.6
6 mm	144	77.2	95.3
8 mm	72	89.2	107.4
4869			
4 mm	480	36.2	45.3
6 mm	180	47.2	56.4
8 mm	144	90.8	109.0
4884			
5.5x5 mm	360	39.0	49.7
6.6x6 mm	360	67.2	78.0
8.8x8 mm	288	111.4	138.1
11x10 mm	144	107.3	127.4



Beads

Shimmering Swarovski Beads set the benchmark for excellence. Meticulously crafted, precision-cut with a clear hole and extraordinary brilliance, the cleverly rounded edge of the hole reduces the wear on threads ensuring design durability.

























Available in a wide range of shapes, cuts, and a large assortment of dazzling hues, from the classically elegant through to the playful and modern, they offer limitless creativity.

Predominantly applied using beading, wiring, stringing, and weaving, the various hole sizes open up new, unlimited applications and design possibilities, infusing every creation with a uniquely radiant shine.







Colors & Effects

Colors

-  Crystal
001
-  White Opal
234
-  Light Silk
261
-  Silk
391
-  Light Peach
362
-  Rosaline
508
-  Rose Water Opal
395
-  Vintage Rose
319
-  Blush Rose
257
-  Light Rose
223
-  Rose Peach
262
-  Padparadscha
542
-  Rose
209
-  Fuchsia
502
-  Light Siam
227
-  Scarlet
276
-  Siam
208
-  Ruby
501
-  Amethyst
204
-  Iris
219
-  Light Amethyst
212
-  Violet
371
-  Tanzanite
539
-  Purple Velvet
277

-  Light Azure
361
-  Aquamarine
202
-  Light Sapphire
211
-  Sapphire
206
-  Capri Blue
243
-  Majestic Blue
296
-  Dark Indigo
288
-  Montana
207
-  Denim Blue
266
-  Light Turquoise
263
-  Blue Zircon
229
-  Erinite
360
-  Citrus Green
337
-  Fern Green
291
-  Majestic Green
336
-  Emerald
205
-  Jonquil
213
-  Light Topaz
226
-  Sunflower
292
-  Light Colorado Topaz
246
-  Topaz
203
-  Greige
284
-  Black Diamond
215
-  Jet
280

Swarovski ReCreated™ Colors

-  ReCreated™ Ice Blue
1405
-  ReCreated™ Dark Sapphire
1404
-  ReCreated™ Peridot
1408
-  ReCreated™ Dark Jonquil
1407
-  ReCreated™ Light Smoked
Topaz
1402
-  ReCreated™ Smoked Topaz
1403



















TCF™ Colors

-  Dark Rose
1201 TCF™
-  Dark Orange
1202 TCF™













Effects

-  Crystal Moonlight
001 MOL
-  Crystal Shimmer
001 SHIM
-  Crystal Aurore Boreale
001 AB
-  Crystal Antique Pink
001 ANTP
-  Crystal Paradise Shine
001 PARSH
-  Crystal Vitrail Medium
001 VM
-  Crystal Blue Shade
001 BLSH
-  Crystal Golden Shadow
001 GSHA
-  Crystal Metallic Sunshine
001 METSH
-  Crystal Aurum
001 AUR2
-  Crystal Rose Gold
001 ROGL
-  Crystal Metallic Light Gold
001 MLGLD
-  Crystal Light Chrome
001 LTCH
-  Crystal Comet Argent Light
001 CAL
-  Crystal Silver Shade
001 SSHA
-  Crystal Silver Night
001 SINI
-  Jet Hematite
280 HEM

Shimmer Effects

-  White Opal Shimmer
234 SHIM
-  Rose Water Opal Shimmer
395 SHIM
-  Light Rose Shimmer
223 SHIM
-  Rose Shimmer
209 SHIM
-  Light Siam Shimmer
227 SHIM
-  Scarlet Shimmer
276 SHIM
-  Siam Shimmer
208 SHIM
-  Amethyst Shimmer
204 SHIM
-  Light Amethyst Shimmer
212 SHIM
-  Aquamarine Shimmer
202 SHIM
-  Light Sapphire Shimmer
211 SHIM
-  Erinite Shimmer
360 SHIM
-  ReCreated™ Peridot Shimmer
1408 SHIM
-  Emerald Shimmer
205 SHIM
-  Light Topaz Shimmer
226 SHIM
-  Light Colorado Topaz Shimmer
246 SHIM
-  Black Diamond Shimmer
215 SHIM
-  Jet Shimmer
280 SHIM

AB Effects

-  Light Rose Aurore Boreale
223 AB
-  Rose Aurore Boreale
209 AB
-  Light Siam Aurore Boreale
227 AB
-  Amethyst Aurore Boreale
204 AB
-  Iris Aurore Boreale
219 AB
-  Violet Aurore Boreale
371 AB
-  Purple Velvet Aurore Boreale
277 AB
-  Aquamarine Aurore Boreale
202 AB
-  Light Sapphire Aurore Boreale
211 AB
-  Sapphire Aurore Boreale
206 AB
-  Capri Blue Aurore Boreale
243 AB
-  Fern Green Aurore Boreale
291 AB
-  Jet Aurore Boreale
280 AB

Numerical Order

001	Crystal	211 AB	Light Sapphire Aurore Boreale	280 HEM	Jet Hematite
001 AB	Crystal Aurore Boreale	211 SHIM	Light Sapphire Shimmer	280 SHIM	Jet Shimmer
001 ANTP	Crystal Antique Pink	212 SHIM	Light Amethyst Shimmer	284	Greige
001 AUR	Crystal Aurum	212	Light Amethyst	288	Dark Indigo
001 BLSH	Crystal Blue Shade	213	Jonquil	291	Fern Green
001 CAL	Crystal Comet Argent Light	215	Black Diamond	291 AB	Fern Green Aurore Boreale
001 GSHA	Crystal Golden Shadow	215 SHIM	Black Diamond Shimmer	292	Sunflower
001 LTCH	Crystal Light Chrome	219	Iris	296	Majestic Blue
001 METSH	Crystal Metallic Sunshine	219 AB	Iris Aurore Boreale	319	Vintage Rose
001 MLGLD	Crystal Metallic Light Gold	223	Light Rose	336	Majestic Green
001 MOL	Crystal Moonlight	223 AB	Light Rose Aurore Boreale	337	Citrus Green
001 PARSH	Crystal Paradise Shine	223 SHIM	Light Rose Shimmer	360	Erinite
001 ROGL	Crystal Rose Gold	226	Light Topaz	360 SHIM	Erinite Shimmer
001 SHIM	Crystal Shimmer	226 SHIM	Light Topaz Shimmer	361	Light Azure
001 SINI	Crystal Silver Night	227	Light Siam	362	Light Peach
001 SSHA	Crystal Silver Shade	227 AB	Light Siam Aurore Boreale	371	Violet
001 VM	Crystal Vitrail Medium	227 SHIM	Light Siam Shimmer	371 AB	Violet Aurore Boreale
202	Aquamarine	229	Blue Zircon	391	Silk
202 AB	Aquamarine Aurore Boreale	234	White Opal	395	Rose Water Opal
202 SHIM	Aquamarine Shimmer	234 SHIM	White Opal Shimmer	395 SHIM	Rose Water Opal Shimmer
203	Topaz	243	Capri Blue	501	Ruby
204	Amethyst	243 AB	Capri Blue Aurore Boreale	502	Fuchsia
204 AB	Amethyst Aurore Boreale	246	Light Colorado Topaz	508	Rosaline
204 SHIM	Amethyst Shimmer	246 SHIM	Light Colorado Topaz Shimmer	539	Tanzanite
205 SHIM	Emerald Shimmer	257	Blush Rose	542	Padparadscha
205	Emerald	261	Light Silk	1201 TCF™	Dark Rose
206	Sapphire	262	Rose Peach	1202 TCF™	Dark Orange
206 AB	Sapphire Aurore Boreale	263	Light Turquoise	1402	ReCreated™ Light Smoked Topaz
207	Montana	266	Denim Blue	1403	ReCreated™ Smoked Topaz
208	Siam	276	Scarlet	1404	ReCreated™ Dark Sapphire
208 SHIM	Siam Shimmer	276 SHIM	Scarlet Shimmer	1405	ReCreated™ Ice Blue
209	Rose	277	Purple Velvet	1407	ReCreated™ Dark Jonquil
209 AB	Rose Aurore Boreale	277 AB	Purple Velvet Aurore Boreale	1408	ReCreated™ Peridot
209 SHIM	Rose Shimmer	280	Jet	1408 SHIM	ReCreated™ Peridot Shimmer
211	Light Sapphire	280 AB	Jet Aurore Boreale		

Alphabetical Order

Amethyst (204)	Emerald Shimmer (205 SHIM)	Montana (207)
Amethyst Aurore Boreale (204 AB)	Erinite (360)	Padparadscha (542)
Amethyst Shimmer (204 SHIM)	Erinite Shimmer (360 SHIM)	Purple Velvet (277)
Aquamarine (202)	Fern Green (291)	Purple Velvet Aurore Boreale (277 AB)
Aquamarine Aurore Boreale (202 AB)	Fern Green Aurore Boreale (291 AB)	ReCreated™ Dark Jonquil (1407)
Aquamarine Shimmer (202 SHIM)	Fuchsia (502)	ReCreated™ Dark Sapphire (1404)
Black Diamond (215)	Greige (284)	ReCreated™ Ice Blue (1405)
Black Diamond Shimmer (215 SHIM)	Iris (219)	ReCreated™ Light Smoked Topaz (1402)
Blue Zircon (229)	Iris Aurore Boreale (219 AB)	ReCreated™ Peridot (1408)
Blush Rose (257)	Jet (280)	ReCreated™ Peridot Shimmer (1408 SHIM)
Capri Blue (243)	Jet Aurore Boreale (280 AB)	ReCreated™ Smoked Topaz (1403)
Capri Blue Aurore Boreale (243 AB)	Jet Hematite (280 HEM)	Rosaline (508)
Citrus Green (337)	Jet Shimmer (280 SHIM)	Rose (209)
Crystal (001)	Jonquil (213)	Rose Aurore Boreale (209 AB)
Crystal Antique Pink (001 ANTP)	Light Amethyst (212)	Rose Peach (262)
Crystal Aurore Boreale (001 AB)	Light Amethyst Shimmer (212 SHIM)	Rose Shimmer (209 SHIM)
Crystal Aurum (001 AUR)	Light Azore (361)	Rose Water Opal (395)
Crystal Blue Shade (001 BLSH)	Light Colorado Topaz (246)	Rose Water Opal Shimmer (395 SHIM)
Crystal Comet Argent Light (001 CAL)	Light Colorado Topaz Shimmer (246 SHIM)	Ruby (501)
Crystal Golden Shadow (001 GSHA)	Light Peach (362)	Sapphire (206)
Crystal Light Chrome (001 LTCH)	Light Rose (223)	Sapphire Aurore Boreale (206 AB)
Crystal Metallic Light Gold (001 MLGLD)	Light Rose Aurore Boreale (223 AB)	Scarlet (276)
Crystal Metallic Sunshine (001 METSH)	Light Rose Shimmer (223 SHIM)	Scarlet Shimmer (276 SHIM)
Crystal Moonlight (001 MOL)	Light Sapphire (211)	Siam (208)
Crystal Paradise Shine (001 PARSH)	Light Sapphire Aurore Boreale (211 AB)	Siam Shimmer (208 SHIM)
Crystal Rose Gold (001 ROGL)	Light Sapphire Shimmer (211 SHIM)	Silk (391)
Crystal Shimmer (001 SHIM)	Light Siam (227)	Sunflower (292)
Crystal Silver Night (001 SINI)	Light Siam Aurore Boreale (227 AB)	Tanzanite (539)
Crystal Silver Shade (001 SHA)	Light Siam Shimmer (227 SHIM)	Topaz (203)
Crystal Vitrail Medium (001 VM)	Light Silk (261)	Vintage Rose (319)
Dark Indigo (288)	Light Topaz (226)	Violet (371)
Dark Orange (1202 TCF™)	Light Topaz Shimmer (226 SHIM)	Violet Aurore Boreale (371 AB)
Dark Rose (1201 TCF™)	Light Turquoise (263)	White Opal (234)
Denim Blue (266)	Majestic Blue (296)	White Opal Shimmer (234 SHIM)
Emerald (205)	Majestic Green (336)	

For details on available colors and effects for each article within the product groups, please see the product matrix of the respective item in the Collection 2026.

The plating resistance of effects is tested according to Swarovski's plating guidelines (SWAROVSKI.COM/S-PROFESSIONALS). Customers are advised to carry out their own tests if their plating parameters diverge from Swarovski plating guidelines.

For more 1x/2x effect options please refer to the specific article overviews.

Colors and effects can appear different when illuminated with different light sources. Swarovski uses standard light source D65

for color decision and comparison. Slight changes in shades are unavoidable. Colors may vary according to cut and foiling. The composition of Advanced Crystal is compliant with regulatory industry norms and laws regarding the restriction or prohibition of certain substances in the most relevant segments of our customers. Please note that the compliance of the colors Light Siam and Siam varies according to certain industry regulations. Those regulations are indicated with * in the compliance overview. Indian Siam, Ruby and Scarlet (option to Lt. Siam) conform to all CLEAR-lists. For further information please visit swarovski.com/s-professionals

© 2026 D. Swarovski Distribution GmbH

Summary

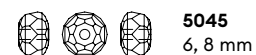
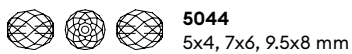
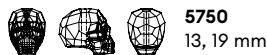
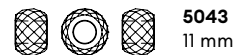
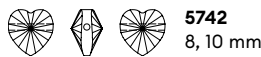
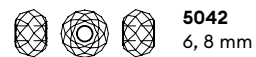
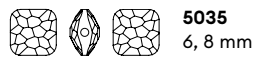
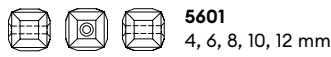
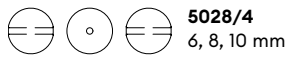
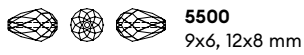
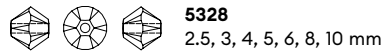
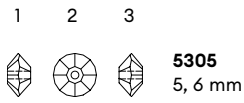
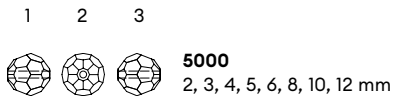

5000 Classic Bead



Size	2 mm	3 mm	4 mm	5 mm	6 mm	8 mm	10 mm	12 mm
------	------	------	------	------	------	------	-------	-------

Crystal

Crystal (001)

Colors

Plain Colors

Amethyst (204)

Aquamarine (202)

Black Diamond (215)

Blue Zircon (229)

Capri Blue (243)

Citrus Green (337)

Denim Blue (266)

Emerald (205)

Erinite (360)

Fuchsia (502)

Jet (280)

Jonquil (213)

Light Amethyst (212)

Light Azore (361)

Light Colorado Topaz (246)

Light Rose (223)

Light Sapphire (211)

Light Siam (227)

Light Topaz (226)

Light Turquoise (263)

Majestic Green (336)

Montana (207)

Rose (209)

Rose Peach (262)

Sapphire (206)

Scarlet (276)

Siam (208)

Silk (391)

Tanzanite (539)

Topaz (203)

Vintage Rose (319)

Violet (371)

Opal Colors

White Opal (234)

Crystal (001)	■	■	■	■	■	■	■	■
Amethyst (204)	■	■	■		■	■	■	
Aquamarine (202)	■	■	■	■	■	■	■	■
Black Diamond (215)	■	■	■	■	■	■	■	
Blue Zircon (229)			■		■	■		
Capri Blue (243)			■		■	■		
Citrus Green (337)			■		■	■		
Denim Blue (266)	■	■	■	■	■	■		
Emerald (205)	■	■	■	■	■	■	■	
Erinite (360)			■		■	■		
Fuchsia (502)		■	■		■	■		
Jet (280)	■	■	■	■	■	■	■	
Jonquil (213)			■		■	■		
Light Amethyst (212)			■		■	■		
Light Azore (361)			■		■	■		
Light Colorado Topaz (246)	■	■	■	■	■	■	■	■
Light Rose (223)	■	■	■	■	■	■	■	
Light Sapphire (211)			■		■	■		
Light Siam (227)	■	■	■		■	■	■	
Light Topaz (226)			■		■	■		
Light Turquoise (263)			■		■	■		
Majestic Green (336)			■		■	■		
Montana (207)	■	■	■	■	■	■		
Rose (209)	■	■	■	■	■	■	■	
Rose Peach (262)			■		■	■		
Sapphire (206)			■		■	■		
Scarlet (276)		■	■		■	■	■	
Siam (208)	■	■	■		■	■	■	
Silk (391)			■		■	■		
Tanzanite (539)	■		■		■	■		
Topaz (203)			■		■	■		
Vintage Rose (319)	■	■	■	■	■	■		
Violet (371)			■		■	■		
White Opal (234)		■	■		■	■		

	Size	2 mm	3 mm	4 mm	5 mm	6 mm	8 mm	10 mm	12 mm
5000									
ReCreated™ Colors									
ReCreated™ Dark Jonquil (1407)				■		■	■		
ReCreated™ Dark Sapphire (1404)				■		■	■		
ReCreated™ Ice Blue (1405)				■		■	■		
ReCreated™ Light Smoked Topaz (1402)				■		■			
ReCreated™ Peridot (1408)				■		■	■		
ReCreated™ Smoked Topaz (1403)				■		■			
TCF™ Colors									
Dark Orange (1202 TCF™)				■		■	■		
Dark Rose (1201 TCF™)				■		■	■		
Crystal Effects									
Transparent Effects									
Crystal Aurore Boreale (001 AB)		■	■	■	■	■	■	■	■
Crystal Blue Shade (001 BLSH)				■		■	■		
Crystal Golden Shadow (001 GSHA)		■	■	■		■	■	■	
Crystal Moonlight (001 MOL)		■		■		■	■		
Crystal Shimmer (001 SHIM)				■		■	■		
Crystal Silver Night (001 SINI)		■	■	■		■	■		
Crystal Silver Shade (001 SSHA)		■	■	■		■	■		
Metallic Effects									
Crystal Aurum 2x (001 AUR2)			■	■		■	■		
Crystal Light Chrome (001 LTCH)		■	■	■		■	■		
Crystal Rose Gold (001 ROGL)			■	■		■			
Color Effects									
Transparent Effects									
Amethyst Shimmer (204 SHIM)				■		■	■		
Aquamarine Shimmer (202 SHIM)				■		■	■		
Jet Aurore Boreale (280 AB)				■		■	■		
Light Amethyst Shimmer (212 SHIM)				■		■	■		
Light Rose Shimmer (223 SHIM)				■		■	■		
Light Siam Aurore Boreale (227 AB)				■		■	■		
ReCreated™ Peridot Shimmer (1408 SHIM)				■		■	■		
Rose Aurore Boreale (209 AB)				■		■	■		
Rose Shimmer (209 SHIM)				■		■	■		
Rose Water Opal Shimmer (395 SHIM)				■		■	■		
Siam Shimmer (208 SHIM)				■		■	■		
White Opal Shimmer (234 SHIM)				■		■	■		

5003 Disco Ball Bead

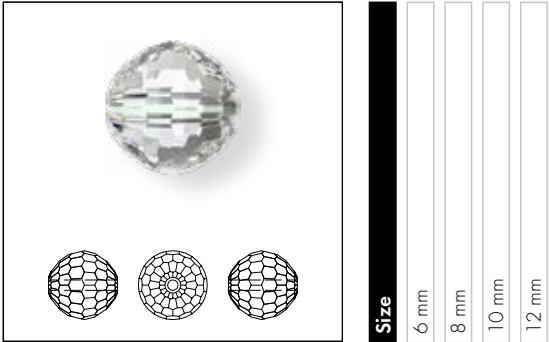

Size
6 mm
8 mm
10 mm
12 mm

Crystal

Crystal (001)

Crystal Effects

Transparent Effects

Crystal Aurore Boreale (001 AB)

5020 Helix Bead

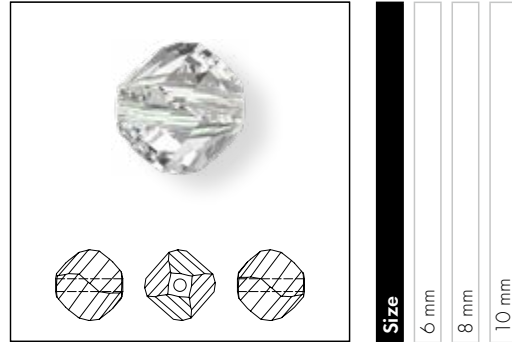

Size
6 mm
8 mm
10 mm

Crystal

Crystal (001)

Crystal Effects

Transparent Effects

Crystal Aurore Boreale (001 AB)

Crystal Golden Shadow (001 GSHA)

5028/4 Crystal Globe Bead

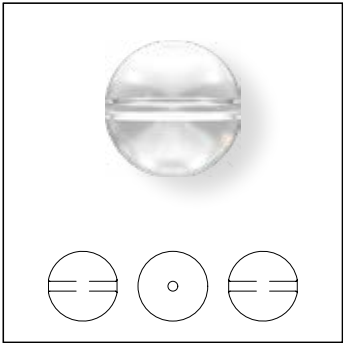

Size
6 mm
8 mm
10 mm

Crystal

Crystal (001)

Crystal Effects

Transparent Effects

Crystal Aurore Boreale (001 AB)

5034 Fantasy Round Bead

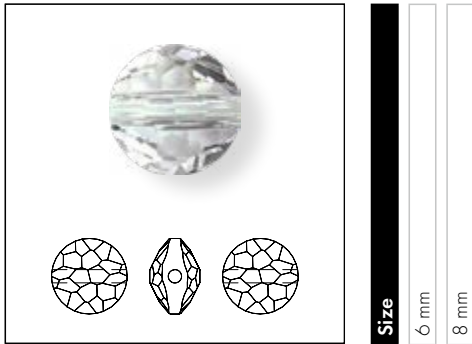

Size
6 mm
8 mm

Crystal		
	Crystal (001)	<input type="checkbox"/>
Colors		
Plain Colors		
	Amethyst (204)	<input type="checkbox"/>
	Aquamarine (202)	<input type="checkbox"/>
	Black Diamond (215)	<input type="checkbox"/>
	Fern Green (291)	<input type="checkbox"/>
	Fuchsia (502)	<input type="checkbox"/>
	Jet (280)	<input type="checkbox"/>
	Light Rose (223)	<input type="checkbox"/>
	Light Siam (227)	<input type="checkbox"/>
	Light Topaz (226)	<input type="checkbox"/>
	Majestic Green (336)	<input type="checkbox"/>
	Montana (207)	<input type="checkbox"/>
ReCreated™ Colors		
	ReCreated™ Dark Sapphire (1404)	<input type="checkbox"/>
	ReCreated™ Peridot (1408)	<input type="checkbox"/>
TCF™ Colors		
	Dark Orange (1202 TCF™)	<input type="checkbox"/>
	Dark Rose (1201 TCF™)	<input type="checkbox"/>
Crystal Effects		
Transparent Effects		
	Crystal Aurore Boreale (001 AB)	<input type="checkbox"/>
	Crystal Golden Shadow (001 GSHA)	<input type="checkbox"/>
	Crystal Silver Night (001 SINI)	<input type="checkbox"/>
Metallic Effects		
	Crystal Aurum 2x (001 AUR2)	<input type="checkbox"/>

5035 Fantasy Square Bead



Size
6 mm
8 mm

Crystal		
	Crystal (001)	<input type="checkbox"/>
Colors		
Plain Colors		
	Amethyst (204)	<input type="checkbox"/>
	Aquamarine (202)	<input type="checkbox"/>
	Fern Green (291)	<input type="checkbox"/>
	Fuchsia (502)	<input type="checkbox"/>
	Jet (280)	<input type="checkbox"/>
	Light Sapphire (211)	<input type="checkbox"/>
	Light Siam (227)	<input type="checkbox"/>
	Light Topaz (226)	<input type="checkbox"/>
	Montana (207)	<input type="checkbox"/>
	Sapphire (206)	<input type="checkbox"/>
TCF™ Colors		
	Dark Orange (1202 TCF™)	<input type="checkbox"/>
	Dark Rose (1201 TCF™)	<input type="checkbox"/>
Crystal Effects		
Transparent Effects		
	Crystal Aurore Boreale (001 AB)	<input type="checkbox"/>
	Crystal Golden Shadow (001 GSHA)	<input type="checkbox"/>
	Crystal Silver Night (001 SINI)	<input type="checkbox"/>
Metallic Effects		
	Crystal Aurum 2x (001 AUR2)	<input type="checkbox"/>

5040 Briolette Bead



Size	4 mm	6 mm	8 mm	12 mm
------	------	------	------	-------

Crystal

Crystal (001)

Colors

Plain Colors

- Amethyst (204)
- Aquamarine (202)
- Blue Zircon (229)
- Emerald (205)
- Erinite (360)
- Iris (219)
- Jet (280)
- Light Amethyst (212)
- Light Colorado Topaz (246)
- Light Rose (223)
- Light Sapphire (211)
- Light Siam (227)
- Light Topaz (226)
- Light Turquoise (263)
- Majestic Green (336)
- Rose (209)
- Sapphire (206)
- Scarlet (276)
- Siam (208)
- Tanzanite (539)
- Topaz (203)
- Violet (371)

ReCreated™ Colors

- ReCreated™ Dark Sapphire (1404)
- ReCreated™ Ice Blue (1405)
- ReCreated™ Peridot (1408)

TCF™ Colors

- Dark Orange (1202 TCF™)
- Dark Rose (1201 TCF™)

Crystal (001)				
Amethyst (204)				
Aquamarine (202)				
Blue Zircon (229)				
Emerald (205)				
Erinite (360)				
Iris (219)				
Jet (280)				
Light Amethyst (212)				
Light Colorado Topaz (246)				
Light Rose (223)				
Light Sapphire (211)				
Light Siam (227)				
Light Topaz (226)				
Light Turquoise (263)				
Majestic Green (336)				
Rose (209)				
Sapphire (206)				
Scarlet (276)				
Siam (208)				
Tanzanite (539)				
Topaz (203)				
Violet (371)				
ReCreated™ Dark Sapphire (1404)				
ReCreated™ Ice Blue (1405)				
ReCreated™ Peridot (1408)				
Dark Orange (1202 TCF™)				
Dark Rose (1201 TCF™)				

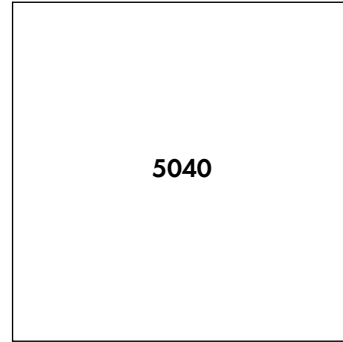

Size	4 mm	6 mm	8 mm	12 mm
------	------	------	------	-------

Crystal Effects

Transparent Effects

- Crystal Aurore Boreale (001 AB)
- Crystal Golden Shadow (001 GSHA)
- Crystal Shimmer 2X (001 SHIM2X)
- Crystal Silver Night (001 SINI)
- Crystal Silver Shade (001 SSHA)

Color Effects

Transparent Effects

- Amethyst Shimmer 2X (204 SHIM2X)
- Aquamarine Shimmer 2x (202 SHIM2)
- Black Diamond Shimmer 2X (215 SHIM2X)
- Erinite Shimmer 2X (360 SHIM2X)
- Light Amethyst Shimmer 2x (212 SHIM2X)
- Light Colorado Topaz Shimmer 2X (246 SHIM2X)
- Light Rose Shimmer 2X (223 SHIM2X)
- Light Sapphire Shimmer 2X (211 SHIM2X)
- Light Siam Shimmer 2X (227 SHIM2X)
- Light Topaz Shimmer 2X (226 SHIM2X)
- Rose Water Opal Shimmer 2X (395 SHIM2X)
- White Opal Shimmer 2X (234 SHIM2X)

Crystal Aurore Boreale (001 AB)				
Crystal Golden Shadow (001 GSHA)				
Crystal Shimmer 2X (001 SHIM2X)				
Crystal Silver Night (001 SINI)				
Crystal Silver Shade (001 SSHA)				
Amethyst Shimmer 2X (204 SHIM2X)				
Aquamarine Shimmer 2x (202 SHIM2)				
Black Diamond Shimmer 2X (215 SHIM2X)				
Erinite Shimmer 2X (360 SHIM2X)				
Light Amethyst Shimmer 2x (212 SHIM2X)				
Light Colorado Topaz Shimmer 2X (246 SHIM2X)				
Light Rose Shimmer 2X (223 SHIM2X)				
Light Sapphire Shimmer 2X (211 SHIM2X)				
Light Siam Shimmer 2X (227 SHIM2X)				
Light Topaz Shimmer 2X (226 SHIM2X)				
Rose Water Opal Shimmer 2X (395 SHIM2X)				
White Opal Shimmer 2X (234 SHIM2X)				

5042 Briolette XL Hole Bead

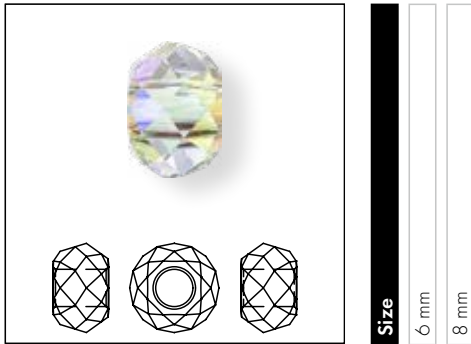

Crystal Effects	
Transparent Effects	
Crystal Shimmer 2X (001 SHIM2X)	■ ■
Color Effects	
Transparent Effects	
Amethyst Shimmer 2X (204 SHIM2X)	■ ■
Aquamarine Shimmer 2x (202 SHIM2)	■ ■
Emerald Shimmer 2X (205 SHIM2X)	■ ■
Jet Shimmer 2X (280 SHIM2X)	■ ■
Light Colorado Topaz Shimmer 2X (246 SHIM2X)	■ ■
Scarlet Shimmer 2X (276 SHIM2X)	■ ■

5043 Briolette XXL Hole Bead

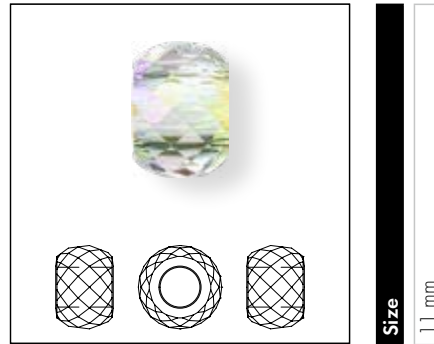

Crystal Effects	
Transparent Effects	
Crystal Shimmer 2X (001 SHIM2X)	■ ■
Color Effects	
Transparent Effects	
Amethyst Shimmer 2X (204 SHIM2X)	■ ■
Aquamarine Shimmer 2x (202 SHIM2)	■ ■
Emerald Shimmer 2X (205 SHIM2X)	■ ■
Jet Shimmer 2X (280 SHIM2X)	■ ■
Light Colorado Topaz Shimmer 2X (246 SHIM2X)	■ ■
Scarlet Shimmer 2X (276 SHIM2X)	■ ■

5044 Olive Briolette Bead

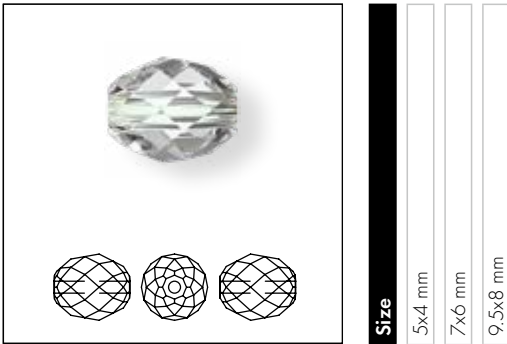

Crystal		
Crystal (001)	■	■
Colors		
Plain Colors		
Amethyst (204)	■	■
Aquamarine (202)	■	■
Blue Zircon (229)	■	■
Emerald (205)	■	■
Jet (280)	■	■
Light Rose (223)	■	■
Light Siam (227)	■	■
Light Turquoise (263)	■	■
Majestic Green (336)	■	■
Rose Peach (262)	■	■
Violet (371)	■	■
ReCreated™ Colors		
ReCreated™ Peridot (1408)	■	■
Crystal Effects		
Transparent Effects		
Crystal Aurore Boreale (001 AB)	■	■
Crystal Golden Shadow (001 GSHA)	■	■

5045 Rondelle Bead

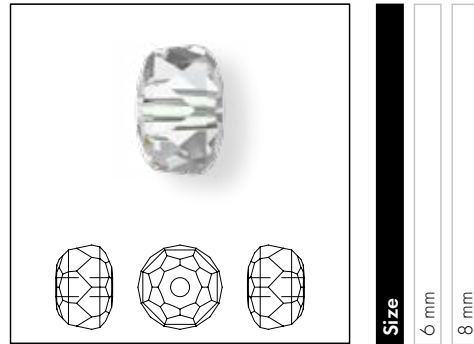

Crystal		
Crystal (001)	■	■
Crystal Effects		
Transparent Effects		
Crystal Aurore Boreale (001 AB)	■	■

06

5305 Slim XILION Bead

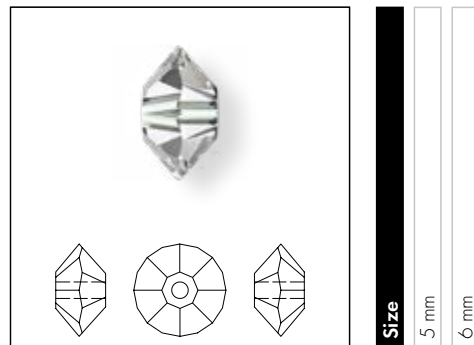

Crystal		
Crystal (001)	■	■
Crystal Effects		
Transparent Effects		
Crystal Aurore Boreale (001 AB)	■	■

5328 XILION Bead



Size	2.5 mm	3 mm	4 mm	5 mm	6 mm	8 mm	10 mm
------	--------	------	------	------	------	------	-------

Crystal

Crystal (001)

Colors

Plain Colors

- Amethyst (204)
- Aquamarine (202)
- Black Diamond (215)
- Blue Zircon (229)
- Blush Rose (257)
- Capri Blue (243)
- Citrus Green (337)
- Dark Indigo (288)
- Denim Blue (266)
- Emerald (205)
- Erinite (360)
- Fern Green (291)
- Fuchsia (502)
- Greige (284)
- Iris (219)
- Jet (280)
- Jonquil (213)
- Light Amethyst (212)
- Light Azore (361)
- Light Colorado Topaz (246)
- Light Peach (362)
- Light Rose (223)
- Light Sapphire (211)
- Light Siam (227)
- Light Silk (261)
- Light Topaz (226)
- Light Turquoise (263)
- Majestic Blue (296)
- Majestic Green (336)
- Montana (207)
- Padparadscha (542)
- Purple Velvet (277)
- Rosaline (508)
- Rose (209)
- Rose Peach (262)

Crystal (001)	■	■	■	■	■	■	■
Amethyst (204)	■	■	■	■	■	■	■
Aquamarine (202)	■	■	■	■	■	■	■
Black Diamond (215)		■	■	■	■	■	■
Blue Zircon (229)		■	■	■	■	■	■
Blush Rose (257)		■	■	■	■	■	■
Capri Blue (243)		■	■	■	■	■	■
Citrus Green (337)		■	■	■	■	■	■
Dark Indigo (288)		■	■	■	■	■	■
Denim Blue (266)		■	■	■	■	■	■
Emerald (205)	■	■	■	■	■	■	■
Erinite (360)		■	■	■	■	■	■
Fern Green (291)		■	■	■	■	■	■
Fuchsia (502)		■	■	■	■	■	■
Greige (284)		■	■	■	■	■	■
Iris (219)		■	■	■	■	■	■
Jet (280)	■	■	■	■	■	■	■
Jonquil (213)		■	■	■	■	■	■
Light Amethyst (212)		■	■	■	■	■	■
Light Azore (361)		■	■	■	■	■	■
Light Colorado Topaz (246)	■	■	■	■	■	■	■
Light Peach (362)		■	■	■	■	■	■
Light Rose (223)	■	■	■	■	■	■	■
Light Sapphire (211)		■	■	■	■	■	■
Light Siam (227)		■	■	■	■	■	■
Light Silk (261)		■	■	■	■	■	■
Light Topaz (226)		■	■	■	■	■	■
Light Turquoise (263)		■	■	■	■	■	■
Majestic Blue (296)		■	■	■	■	■	■
Majestic Green (336)		■	■	■	■	■	■
Montana (207)		■	■	■	■	■	■
Padparadscha (542)		■	■	■	■	■	■
Purple Velvet (277)		■	■	■	■	■	■
Rosaline (508)		■	■	■	■	■	■
Rose (209)		■	■	■	■	■	■
Rose Peach (262)		■	■	■	■	■	■

5328	Size						
	2.5 mm	3 mm	4 mm	5 mm	6 mm	8 mm	10 mm
Ruby (501)		■	■	■	■		
Sapphire (206)		■	■	■	■	■	
Scarlet (276)	■	■	■	■	■		
Siam (208)		■	■	■	■	■	
Silk (391)		■	■	■	■		
Sunflower (292)		■	■				
Tanzanite (539)		■	■	■	■		
Topaz (203)		■	■	■	■		
Vintage Rose (319)		■	■	■	■		
Violet (371)		■	■	■	■		
Opal Colors							
Rose Water Opal (395)		■	■	■	■		
White Opal (234)		■	■	■	■		
ReCreated™ Colors							
ReCreated™ Dark Jonquil (1407)		■	■		■		
ReCreated™ Dark Sapphire (1404)		■	■				
ReCreated™ Ice Blue (1405)		■	■				
ReCreated™ Light Smoked Topaz (1402)		■	■				
ReCreated™ Peridot (1408)		■	■	■	■	■	
ReCreated™ Smoked Topaz (1403)		■	■				
TCF™ Colors							
Dark Orange (1202 TCF™)		■	■	■	■		
Dark Rose (1201 TCF™)		■	■	■	■		
Crystal Effects							
Transparent Effects							
Crystal Antique Pink (001 ANTP)		■	■				
Crystal Aurore Boreale (001 AB)	■	■	■	■	■	■	■
Crystal Aurore Boreale 2x (001 AB2)		■	■	■	■		
Crystal Blue Shade (001 BLSH)		■	■	■	■		
Crystal Golden Shadow (001 GSHA)	■	■	■	■	■	■	
Crystal Moonlight (001 MOL)		■	■	■	■		
Crystal Paradise Shine (001 PARSH)		■	■	■	■		
Crystal Paradise Shine 2x (001 PARS2)			■				
Crystal Shimmer (001 SHIM)		■	■	■	■		
Crystal Shimmer 2X (001 SHIM2X)		■	■				
Crystal Silver Night (001 SINI)		■	■	■			
Crystal Silver Shade (001 SSHA)	■	■	■	■	■	■	
Crystal Vitrail Medium (001 VM)		■	■				

5328	Size						
	2.5 mm	3 mm	4 mm	5 mm	6 mm	8 mm	10 mm
Metallic Effects							
Crystal Aurum 2x (001 AUR2)		■	■	■	■		
Crystal Comet Argent Light (001 CAL)		■	■	■	■		
Crystal Light Chrome (001 LTCH)		■	■				
Crystal Light Chrome 2x (001 LTCH2)			■				
Crystal Metallic Light Gold 2x (001 MLG2)		■	■				
Crystal Metallic Sunshine (001 METSH)		■	■	■	■		
Crystal Metallic Sunshine 2x (001 MTSH2)			■				
Crystal Rose Gold (001 ROGL)		■	■				
Crystal Rose Gold 2x (001 ROGL2)		■	■	■	■		
Color Effects							
Transparent Effects							
Amethyst Aurore Boreale (204 AB)		■	■				
Amethyst Shimmer (204 SHIM)		■	■				
Amethyst Shimmer 2X (204 SHIM2X)		■	■				
Aquamarine Aurore Boreale (202 AB)		■	■				
Aquamarine Shimmer (202 SHIM)		■	■	■	■		
Aquamarine Shimmer 2x (202 SHIM2)		■	■				
Black Diamond Shimmer (215 SHIM)		■	■				
Black Diamond Shimmer 2X (215 SHIM2X)		■	■				
Capri Blue Aurore Boreale (243 AB)		■	■				
Fern Green Aurore Boreale (291 AB)		■	■				
Iris Aurore Boreale 2X (219 AB2)		■	■				
Jet Aurore Boreale (280 AB)		■	■	■	■		
Jet Aurore Boreale 2x (280 AB2)		■	■				
Light Amethyst Shimmer (212 SHIM)		■	■		■		
Light Amethyst Shimmer 2x (212 SHIM2X)		■	■				
Light Rose Aurore Boreale (223 AB)		■	■	■	■		
Light Rose Aurore Boreale 2x (223 AB2)		■	■				
Light Rose Shimmer (223 SHIM)		■	■		■		
Light Rose Shimmer 2X (223 SHIM2X)		■	■				
Light Sapphire Aurore Boreale (211 AB)		■	■				
Light Sapphire Shimmer 2X (211 SHIM2X)		■	■				
Light Siam Aurore Boreale (227 AB)		■	■				
Light Siam Shimmer 2X (227 SHIM2X)		■	■				
Purple Velvet Aurore Boreale (277 AB)		■	■				
ReCreated™ Peridot Aurore Boreale (1408 AB)			■				

	5328							
	Size	2.5 mm	3 mm	4 mm	5 mm	6 mm	8 mm	10 mm
ReCreated™ Peridot Shimmer (1408 SHIM)			■	■		■		
ReCreated™ Peridot Shimmer 2X (1408 SHIM2X)			■	■				
Rose Aurore Boreale (209 AB)			■	■				
Rose Shimmer (209 SHIM)			■	■				
Rose Shimmer 2x (209 SHIM2X)			■	■				
Rose Water Opal Shimmer (395 SHIM)			■	■	■	■		
Rose Water Opal Shimmer 2X (395 SHIM2X)			■	■				
Sapphire Aurore Boreale (206 AB)			■	■				
Siam Shimmer (208 SHIM)			■	■				
Siam Shimmer 2x (208 SHIM2X)			■	■				
Violet Aurore Boreale (371 AB)			■	■				
White Opal Shimmer (234 SHIM)			■	■	■	■		
White Opal Shimmer 2X (234 SHIM2X)			■	■				
Metallic Effects								
Jet Hematite (280 HEM)			■	■				
Jet Hematite 2x (280 HEM2)			■	■				

5500 Drop Bead

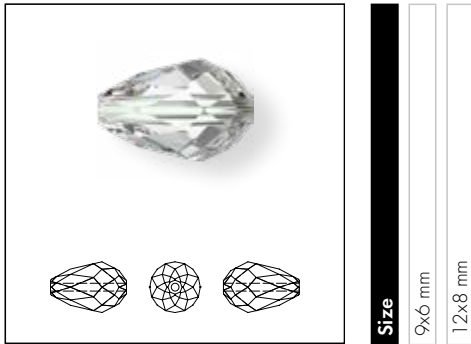

Size

9x6 mm

12x8 mm

Crystal

Crystal (001)

Colors

Plain Colors

- Amethyst (204)
- Aquamarine (202)
- Blue Zircon (229)
- Emerald (205)
- Light Amethyst (212)
- Light Colorado Topaz (246)
- Light Rose (223)
- Light Siam (227)
- Rose (209)
- Sapphire (206)
- Scarlet (276)
- Siam (208)

ReCreated™ Colors

ReCreated™ Peridot (1408)

Crystal Effects

Transparent Effects

- Crystal Aurore Boreale (001 AB)
- Crystal Golden Shadow (001 GSHA)
- Crystal Shimmer 2X (001 SHIM2X)

Color Effects

Transparent Effects

- Amethyst Shimmer 2X (204 SHIM2X)
- Aquamarine Shimmer 2x (202 SHIM2)
- Light Colorado Topaz Shimmer 2X (246 SHIM2X)
- Light Siam Shimmer 2X (227 SHIM2X)

5542 Dome Bead small

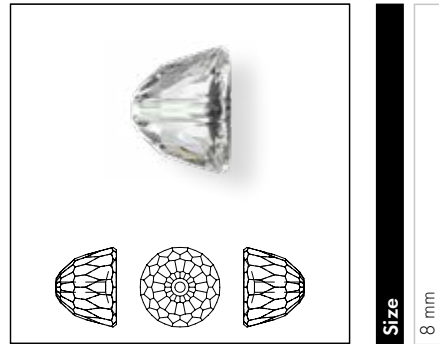

Size

8 mm

Crystal

Crystal (001)

Crystal Effects

Transparent Effects

- Crystal Aurore Boreale (001 AB)
- Crystal Golden Shadow (001 GSHA)

5601 Cube Bead

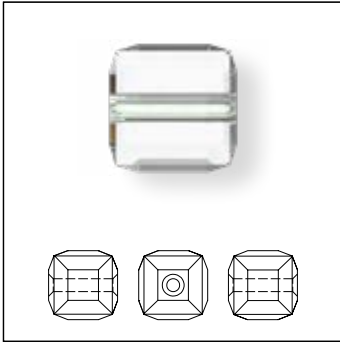

Size	4 mm	6 mm	8 mm	10 mm	12 mm
------	------	------	------	-------	-------

Crystal

Crystal (001)

Colors

Plain Colors

- Amethyst (204)
- Aquamarine (202)
- Black Diamond (215)
- Blue Zircon (229)
- Blush Rose (257)
- Emerald (205)
- Erinite (360)
- Fuchsia (502)
- Iris (219)
- Jet (280)
- Light Colorado Topaz (246)
- Light Sapphire (211)
- Light Siam (227)
- Light Topaz (226)
- Light Turquoise (263)
- Majestic Blue (296)
- Majestic Green (336)
- Rose Peach (262)
- Sapphire (206)
- Siam (208)
- Tanzanite (539)
- Topaz (203)

Opal Colors

- Rose Water Opal (395)
- White Opal (234)

ReCreated™ Colors

- ReCreated™ Dark Jonquil (1407)
- ReCreated™ Dark Sapphire (1404)
- ReCreated™ Ice Blue (1405)
- ReCreated™ Light Smoked Topaz (1402)
- ReCreated™ Peridot (1408)
- ReCreated™ Smoked Topaz (1403)

TCF™ Colors

- Dark Orange (1202 TCF™)
- Dark Rose (1201 TCF™)

Crystal (001)	■	■	■	■	■
Amethyst (204)	■	■	■		
Aquamarine (202)	■	■	■		
Black Diamond (215)	■	■	■		
Blue Zircon (229)	■	■	■		
Blush Rose (257)	■	■	■		
Emerald (205)	■	■	■		
Erinite (360)	■	■	■		
Fuchsia (502)	■	■	■		
Iris (219)	■	■	■		
Jet (280)	■	■	■		
Light Colorado Topaz (246)	■	■	■		
Light Sapphire (211)	■	■	■		
Light Siam (227)	■	■	■		
Light Topaz (226)	■	■	■		
Light Turquoise (263)	■	■	■		
Majestic Blue (296)	■	■			
Majestic Green (336)	■	■	■		
Rose Peach (262)	■	■	■		
Sapphire (206)	■	■	■		
Siam (208)	■	■	■		
Tanzanite (539)	■	■	■		
Topaz (203)	■	■	■		
Rose Water Opal (395)	■	■			
White Opal (234)	■	■			
ReCreated™ Dark Jonquil (1407)	■	■			
ReCreated™ Dark Sapphire (1404)	■	■	■		
ReCreated™ Ice Blue (1405)	■	■	■		
ReCreated™ Light Smoked Topaz (1402)	■	■			
ReCreated™ Peridot (1408)	■	■	■		
ReCreated™ Smoked Topaz (1403)	■	■			
Dark Orange (1202 TCF™)	■	■	■		
Dark Rose (1201 TCF™)	■	■	■		

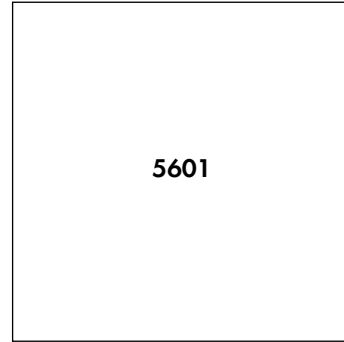

Size	4 mm	6 mm	8 mm	10 mm	12 mm
------	------	------	------	-------	-------

Crystal Effects

Transparent Effects

- Crystal Aurore Boreale B (001 ABB)
- Crystal Blue Shade B (001 BLSB)
- Crystal Golden Shadow B (001 GSHAB)
- Crystal Shimmer B (001 SHIMB)
- Crystal Silver Night B (001 SINIB)
- Crystal Vitrail Medium B (001 VMB)

Metallic Effects

- Crystal Light Chrome B (001 LTCHB)
- Crystal Metallic Sunshine B (001 MTSHB)
- Crystal Rose Gold B 2x (001 ROGB2)

Color Effects

Transparent Effects

- Black Diamond Shimmer B (215 SHIMB)
- Erinite Shimmer B (360 SHIMB)
- Light Colorado Topaz Shimmer B (246 SHIMB)
- Light Sapphire Shimmer B (211 SHIMB)
- Light Siam Shimmer B (227 SHIMB)
- Rose Water Opal Shimmer B (395 SHIMB)
- White Opal Shimmer B (234 SHIMB)

Crystal Aurore Boreale B (001 ABB)	■	■	■	■	
Crystal Blue Shade B (001 BLSB)	■	■	■		
Crystal Golden Shadow B (001 GSHAB)	■	■	■		
Crystal Shimmer B (001 SHIMB)	■	■	■		
Crystal Silver Night B (001 SINIB)	■	■	■		
Crystal Vitrail Medium B (001 VMB)	■	■			
Crystal Light Chrome B (001 LTCHB)	■	■	■		
Crystal Metallic Sunshine B (001 MTSHB)	■	■	■		
Crystal Rose Gold B 2x (001 ROGB2)	■	■			
Black Diamond Shimmer B (215 SHIMB)	■	■	■		
Erinite Shimmer B (360 SHIMB)	■	■	■		
Light Colorado Topaz Shimmer B (246 SHIMB)	■	■	■		
Light Sapphire Shimmer B (211 SHIMB)	■	■	■		
Light Siam Shimmer B (227 SHIMB)	■	■	■		
Rose Water Opal Shimmer B (395 SHIMB)	■	■			
White Opal Shimmer B (234 SHIMB)	■	■			

5714 Star Bead

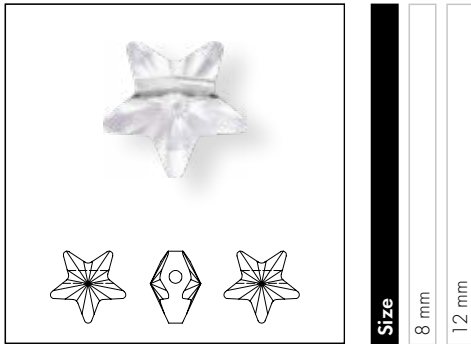

Size
8 mm
12 mm

Crystal

Crystal (001)

Crystal Effects

Transparent Effects

Crystal Aurore Boreale (001 AB)

5741 Love Bead

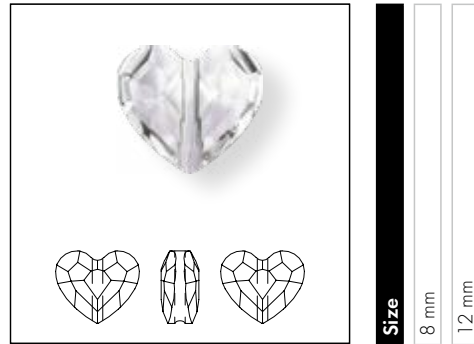

Size
8 mm
12 mm

Crystal

Crystal (001)

Colors

Plain Colors

Blush Rose (257)

Light Siam (227)

Rose (209)

Crystal Effects

Transparent Effects

Crystal Aurore Boreale (001 AB)

Crystal Silver Night 2x (001 SINI2)

5742 Heart Bead

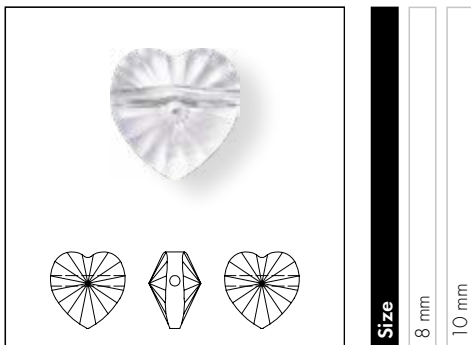

Size
8 mm
10 mm

Crystal

Crystal (001)

Crystal Effects

Transparent Effects

Crystal Aurore Boreale (001 AB)

5750 Skull Bead

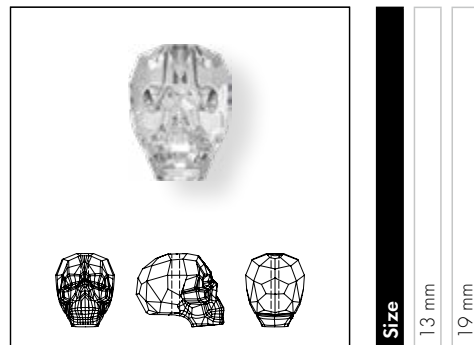

Size
13 mm
19 mm

Crystal

Crystal (001)

Colors

Plain Colors

Jet (280)

Crystal Effects

Transparent Effects

Crystal Paradise Shine (001 PARSH)

Crystal Silver Night (001 SINI)

Crystal Silver Night 2x (001 SINI2)

Metallic Effects

Crystal Metallic Light Gold 2x (001 MLG2)

5752 Clover Bead

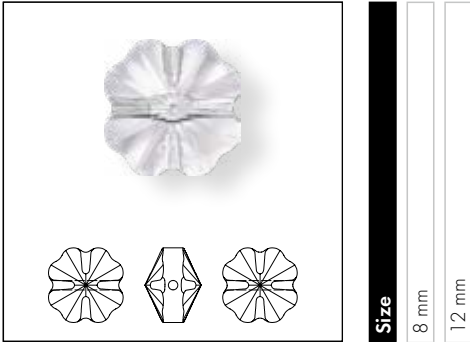

Crystal			
Crystal (001)		■	■
Colors			
Plain Colors			
Fern Green (291)		■	■
Crystal Effects			
Transparent Effects			
Crystal Aurore Boreale (001 AB)		■	■
Crystal Golden Shadow (001 GSHA)		■	■

5754 Butterfly Bead

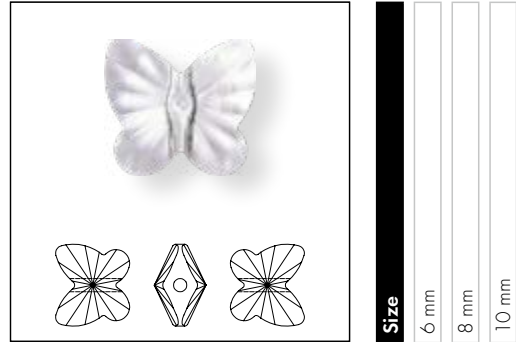

Crystal				
Crystal (001)		■	■	■
Colors				
Plain Colors				
Fuchsia (502)		■	■	
Jet (280)		■	■	■
Light Rose (223)		■	■	■
Light Siam (227)		■	■	■
Violet (371)		■	■	
Crystal Effects				
Transparent Effects				
Crystal Aurore Boreale (001 AB)		■	■	■
Crystal Golden Shadow (001 GSHA)		■	■	■

Product Details

Article Size	Packing Unit = Minimum Order Quantity in Pieces	Average Net Weight in Gram per Packing Unit Crystal (001)	Average Gross Weight in Gram per Packing Unit Crystal (001)
5000			
2 mm	1,440	11.5	20.8
3 mm	720	23.6	33.4
4 mm	720	53.5	62.6
5 mm	720	105.3	116.3
6 mm	360	81.6	92.5
8 mm	288	193.5	200.8
10 mm	144	180.6	199.4
12 mm	72	144.2	166.1
5003			
6 mm	360	109.9	120.8
8 mm	144	100.4	118.6
10 mm	144	195.9	219.2
12 mm	72	158.5	179.2
5020			
6 mm	360	74.5	85.2
8 mm	288	146.6	178.2
10 mm	144	116.4	139.2
5028/4			
6 mm	360	75.791	83.4
8 mm	144	74.714	85.6
10 mm	72	70.763	76.5
5034			
6 mm	288	57.6	67.8
8 mm	144	57.6	75.3
5035			
6 mm	288	76.8	87
8 mm	144	83.9	103
5040			
4 mm	720	41.3	50.4
6 mm	360	71.8	82.9
8 mm	288	135.6	163.7
12 mm	144	214.4	242.4
5042			
6 mm	288	45.7	69.3
8 mm	216	93.4	120.2
5043			
11 mm	12	13.2	31.8
5044			
5x4 mm	360	37.6	47.8
7x6 mm	288	98.1	108.3
9.5x8 mm	72	58.6	77.0

Article Size	Packing Unit = Minimum Order Quantity in Pieces	Average Net Weight in Gram per Packing Unit Crystal (001)	Average Gross Weight in Gram per Packing Unit Crystal (001)
5045			
6 mm	288	60.7	70.9
8 mm	216	117.5	145.9
5305			
5 mm	720	52.7	63.9
6 mm	360	50.5	61.4
5328			
2.5 mm	1,440	23.8	31.4
3 mm	1,440	34.1	45.2
4 mm	1,440	81.8	89.2
5 mm	720	89.3	100.0
6 mm	360	73.7	84.6
8 mm	288	141.8	173.4
10 mm	144	140.4	154.0
5500			
9x6 mm	144	59.0	69.9
12x8 mm	144	144.0	164.1
5542			
8 mm	96	81.4	102.9
5601			
4 mm	288	43.9	65.2
6 mm	144	70.6	88.9
8 mm	96	100.2	118.4
10 mm	72	138.0	156.5
12 mm	36	129.6	147.7
5714			
8 mm	288	73.3	102.1
12 mm	108	72.3	102.2
5741			
8 mm	144	43.3	66.24
12 mm	72	66.2	89.58
5742			
8 mm	288	120.5	154.5
10 mm	288	233.1	266.5
5750			
13 mm	12	24.2	43.8
19 mm	12	73.7	100.0
5752			
8 mm	288	106.1	136.9
12 mm	96	117.7	137.5
5754			
6 mm	360	42.3	53.0
8 mm	288	77.9	109.8
10 mm	288	156.9	188.9



Crystal Pearls

Exquisitely crafted to imitate natural pearls, Swarovski Crystal Pearls captivate with their opalescent luster, inspiring limitless creative expression. Created from a core of light-reflecting crystals enveloped with an outer finish of Swarovski's signature pearl coating, every Crystal Pearl is a testament to innovation, artistry, and timeless style.



















Shimmering with sophistication, their flawless, silky smooth surface offers unparalleled savoir-faire. Whether used alone or in combination with other crystal components, they bring refinement and elegance – with a touch of subtle romance – to any design. A luxurious addition to jewelry, textiles, and even interior décor items, exhibiting luminosity and notable depth, the subtle-hued surface responds to the warmth of the skin.

Available in a dazzling array of hues, from classic tones to contemporary iridescent shades, and a range of shapes and sizes, our stunning assortment offers unmatched perfection and extreme versatility. With multiple hole options, Crystal Pearls allow for a range of application methods, enabling seamless integration into any design.



Colors

Colors

-  Crystal White Pearl
001 650
-  Crystal Light Creamrose Pearl
001 618
-  Crystal Cream Pearl
001 620
-  Crystal Creamrose Pearl
001 621
-  Crystal Light Gold Pearl
001 539
-  Crystal Gold Pearl
001 296
-  Crystal Royal Gold Pearl
001 2034
-  Crystal Vintage Gold Pearl
001 651
-  Crystal Bright Gold Pearl
001 306
-  Crystal Copper Pearl
001 159
-  Crystal Rose Gold Pearl
001 769
-  Crystal Rose Peach Pearl
001 674
-  Crystal Peach Pearl
001 300
-  Crystal Rosaline Pearl
001 294
-  Crystal Powder Rose Pearl
001 352
-  Crystal Dark Coral Pearl
001 196
-  Crystal Elderberry Pearl
001 2019
-  Crystal Light Amethyst Pearl
001 934

-  Crystal Lavender Pearl
001 524
-  Crystal Light Blue Pearl
001 302
-  Crystal Azore Pearl
001 935
-  Crystal Petrol Pearl
001 600
-  Crystal Powder Green Pearl
001 393
-  Crystal Eden Green Pearl
001 2014
-  Crystal Light Green Pearl
001 293
-  Crystal Antique Brass Pearl
001 402
-  Crystal Dark Green Pearl
001 814
-  Crystal Brown Pearl
001 815
-  Crystal Bronze Pearl
001 295
-  Crystal Platinum Pearl
001 459
-  Crystal Moonlight Pearl
001 2033
-  Crystal Light Grey Pearl
001 616
-  Crystal Grey Pearl
001 731
-  Crystal Dark Grey Pearl
001 617
-  Crystal Black Pearl
001 298
-  Crystal Mystic Black Pearl
001 335

Iridescent Colors

-  Crystal Pearlescent White Pearl
001 969
-  Crystal Iridescent Dreamy Rose Pearl
001 2025
-  Crystal Iridescent Dove Grey Pearl
001 954
-  Crystal Iridescent Dreamy Blue Pearl
001 2026
-  Crystal Iridescent Light Blue Pearl
001 948
-  Crystal Iridescent Dark Blue Pearl
001 949
-  Crystal Iridescent Green Pearl
001 930
-  Crystal Iridescent Light Turquoise Pearl
001 2028
-  Crystal Iridescent Dark Turquoise Pearl
001 2029
-  Crystal Iridescent Rouge Pearl
001 2027

Colors

Numerical Order

001 159	Crystal Copper Pearl
001 196	Crystal Dark Coral Pearl
001 293	Crystal Light Green Pearl
001 294	Crystal Rosaline Pearl
001 295	Crystal Bronze Pearl
001 296	Crystal Gold Pearl
001 298	Crystal Black Pearl
001 300	Crystal Peach Pearl
001 302	Crystal Light Blue Pearl
001 306	Crystal Bright Gold Pearl
001 335	Crystal Mystic Black Pearl
001 352	Crystal Powder Rose Pearl
001 393	Crystal Powder Green Pearl
001 402	Crystal Antique Brass Pearl
001 459	Crystal Platinum Pearl
001 524	Crystal Lavender Pearl
001 539	Crystal Light Gold Pearl
001 600	Crystal Petrol Pearl
001 616	Crystal Light Grey Pearl
001 617	Crystal Dark Grey Pearl
001 618	Crystal Light Creamrose Pearl
001 620	Crystal Cream Pearl
001 621	Crystal Creamrose Pearl
001 650	Crystal White Pearl
001 651	Crystal Vintage Gold Pearl
001 674	Crystal Rose Peach Pearl
001 731	Crystal Grey Pearl
001 769	Crystal Rose Gold Pearl
001 814	Crystal Dark Green Pearl
001 815	Crystal Brown Pearl
001 930	Crystal Iridescent Green Pearl
001 934	Crystal Light Amethyst Pearl
001 935	Crystal Azore Pearl
001 948	Crystal Iridescent Light Blue Pearl
001 949	Crystal Iridescent Dark Blue Pearl
001 954	Crystal Iridescent Dove Grey Pearl
001 969	Crystal Pearlescent White Pearl
001 2014	Crystal Eden Green Pearl
001 2019	Crystal Elderberry Pearl
001 2025	Crystal Iridescent Dreamy Rose Pearl
001 2026	Crystal Iridescent Dreamy Blue Pearl
001 2027	Crystal Iridescent Rouge Pearl
001 2028	Crystal Iridescent Light Turquoise Pearl
001 2029	Crystal Iridescent Dark Turquoise Pearl
001 2033	Crystal Moonlight Pearl
001 2034	Crystal Royal Gold Pearl

Alphabetical Order

Crystal Antique Brass Pearl (001 402)
Crystal Azore Pearl (001 935)
Crystal Black Pearl (001 298)
Crystal Bright Gold Pearl (001 306)
Crystal Bronze Pearl (001 295)
Crystal Brown Pearl (001 815)
Crystal Copper Pearl (001 159)
Crystal Cream Pearl (001 620)
Crystal Creamrose Pearl (001 621)
Crystal Dark Coral Pearl (001 196)
Crystal Dark Green Pearl (001 814)
Crystal Dark Grey Pearl (001 617)
Crystal Eden Green Pearl (001 2014)
Crystal Elderberry Pearl (001 2019)
Crystal Gold Pearl (001 296)
Crystal Grey Pearl (001 731)
Crystal Iridescent Dark Blue Pearl (001 949)
Crystal Iridescent Dark Turquoise Pearl (001 2029)
Crystal Iridescent Dove Grey Pearl (001 954)
Crystal Iridescent Dreamy Blue Pearl (001 2026)
Crystal Iridescent Dreamy Rose Pearl (001 2025)
Crystal Iridescent Green Pearl (001 930)
Crystal Iridescent Light Blue Pearl (001 948)
Crystal Iridescent Light Turquoise Pearl (001 2028)
Crystal Iridescent Rouge Pearl (001 2027)
Crystal Lavender Pearl (001 524)
Crystal Light Amethyst Pearl (001 934)
Crystal Light Blue Pearl (001 302)
Crystal Light Creamrose Pearl (001 618)
Crystal Light Gold Pearl (001 539)
Crystal Light Green Pearl (001 293)
Crystal Light Grey Pearl (001 616)
Crystal Moonlight Pearl (001 2033)
Crystal Mystic Black Pearl (001 335)
Crystal Peach Pearl (001 300)
Crystal Pearlescent White Pearl (001 969)
Crystal Petrol Pearl (001 600)
Crystal Platinum Pearl (001 459)
Crystal Powder Green Pearl (001 393)
Crystal Powder Rose Pearl (001 352)
Crystal Rosaline Pearl (001 294)
Crystal Rose Gold Pearl (001 769)
Crystal Rose Peach Pearl (001 674)
Crystal Royal Gold Pearl (001 2034)
Crystal Vintage Gold Pearl (001 651)
Crystal White Pearl (001 650)

Summary

1 2 3

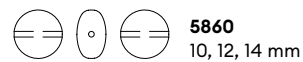
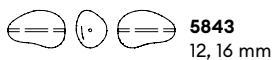
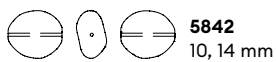
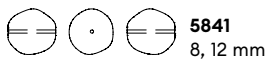
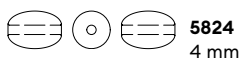
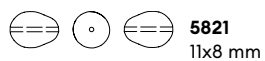
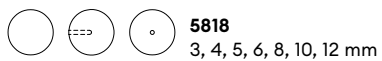
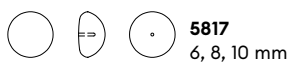
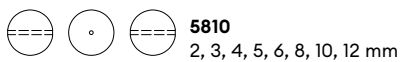

1 Top view 2 Side view 3 Back view

Ordering Example & Product Variety Explanation

5810 Crystal Round Pearl

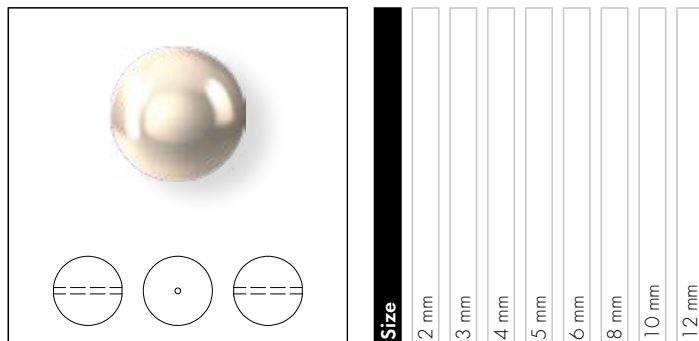

5810	2 mm	001 650
-------------	-------------	----------------

07

Article number

Crystal Pearl size

Color

All sizes are subject to special orders.

Desired Crystal Pearl color code

Please see respective product matrix for all available reference codes.

5809 Crystal No Hole Pearl

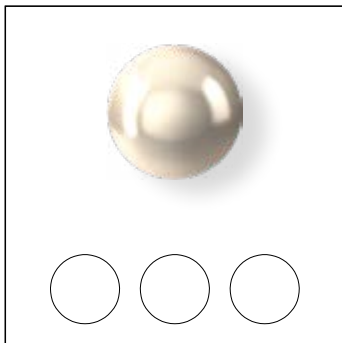

Size
1 mm
1.5 mm
2 mm
2.5 mm
3 mm
3.5 mm

Pearl Colors

 Crystal Cream Pearl (001 CRM)	■	■	■	■	■	■
 Crystal Creamrose Pearl (001 CRMR)	■	■	■	■	■	■
 Crystal White Pearl (001 WHITE)	■	■	■	■	■	■

5810 Crystal Round Pearl

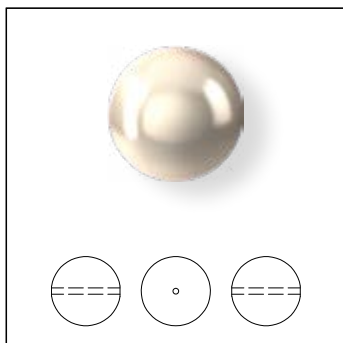

Size	2 mm	3 mm	4 mm	5 mm	6 mm	8 mm	10 mm	12 mm
------	------	------	------	------	------	------	-------	-------

Pearl Colors

Crystal Antique Brass Pearl (001 ABPRL)	■	■	■	■	■	■	■	■
Crystal Azore Pearl (001 AZPRL)	■	■	■	■	■	■	■	■
Crystal Black Pearl (001 BLPRL)	■	■	■	■	■	■	■	■
Crystal Bright Gold Pearl (001 BGPRL)	■	■	■	■	■	■	■	■
Crystal Bronze Pearl (001 BRPRL)	■	■	■	■	■	■	■	■
Crystal Brown Pearl (001 BWPRL)	■	■	■	■	■	■	■	■
Crystal Copper Pearl (001 COPRL)	■	■	■	■	■	■	■	■
Crystal Cream Pearl (001 CRM)	■	■	■	■	■	■	■	■
Crystal Creamrose Light Pearl (001 CRLT)	■	■	■	■	■	■	■	■
Crystal Creamrose Pearl (001 CRMR)	■	■	■	■	■	■	■	■
Crystal Dark Coral Pearl (001 DCPRL)	■	■	■	■	■	■	■	■
Crystal Dark Green Pearl (001 DGPRL)	■	■	■	■	■	■	■	■
Crystal Dark Grey Pearl (001 DGREY)	■	■	■	■	■	■	■	■
Crystal Eden Green Pearl (001 EDGRP)	■	■	■	■	■	■	■	■
Crystal Elderberry Pearl (001 ELBEP)	■	■	■	■	■	■	■	■
Crystal Gold Pearl (001 GOPRL)	■	■	■	■	■	■	■	■
Crystal Grey Pearl (001 GRPRL)	■	■	■	■	■	■	■	■
Crystal Lavender Pearl (001 LAPRL)	■	■	■	■	■	■	■	■
Crystal Light Amethyst Pearl (001 LTAMP)	■	■	■	■	■	■	■	■
Crystal Light Blue Pearl (001 LTBLP)	■	■	■	■	■	■	■	■
Crystal Light Gold Pearl (001 LGPRL)	■	■	■	■	■	■	■	■
Crystal Light Green Pearl (001 LTGRP)	■	■	■	■	■	■	■	■
Crystal Light Grey Pearl (001 LGREY)	■	■	■	■	■	■	■	■
Crystal Moonlight Pearl (001 MOONP)	■	■	■	■	■	■	■	■
Crystal Peach Pearl (001 PEPRL)	■	■	■	■	■	■	■	■
Crystal Petrol Pearl (001 PLPRL)	■	■	■	■	■	■	■	■
Crystal Platinum Pearl (001 PTPRL)	■	■	■	■	■	■	■	■
Crystal Powder Green Pearl (001 PGPRL)	■	■	■	■	■	■	■	■
Crystal Powder Rose Pearl (001 PRPRL)	■	■	■	■	■	■	■	■
Crystal Rosaline Pearl (001 ROPRL)	■	■	■	■	■	■	■	■
Crystal Rose Gold Pearl (001 RGPRL)	■	■	■	■	■	■	■	■
Crystal Rose Peach Pearl (001 ROPEP)	■	■	■	■	■	■	■	■
Crystal Royal Gold Pearl (001 ROYGP)	■	■	■	■	■	■	■	■
Crystal Vintage Gold Pearl (001 VGPRL)	■	■	■	■	■	■	■	■
Crystal White Pearl (001 WHITE)	■	■	■	■	■	■	■	■

Pearl Gemcolors

Crystal Mystic Black Pearl (001 MBPRL)	■	■	■	■	■	■	■	■
--	---	---	---	---	---	---	---	---

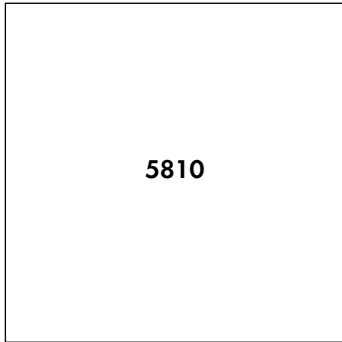

Size	2 mm	3 mm	4 mm	5 mm	6 mm	8 mm	10 mm	12 mm
------	------	------	------	------	------	------	-------	-------

Iridescent Pearl Colors

Crystal Iridescent Dark Blue Pearl (001 IDBLP)	■	■	■	■	■	■	■	■
Crystal Irid. Dark Turquoise Pearl (001 IDTUP)	■	■	■	■	■	■	■	■
Crystal Iridescent Dove Grey Pearl (001 IDGYP)	■	■	■	■	■	■	■	■
Crystal Iridescent Dreamy Blue (001 IDRBP)	■	■	■	■	■	■	■	■
Crystal Iridescent Dreamy Rose (001 IDROP)	■	■	■	■	■	■	■	■
Crystal Iridescent Green Pearl (001 IGPRL)	■	■	■	■	■	■	■	■
Crystal Iridescent Light Blue Pearl (001 ILBLP)	■	■	■	■	■	■	■	■
Crystal Irid. Light Turquoise Pearl (001 ILTUP)	■	■	■	■	■	■	■	■
Crystal Iridescent Rouge Pearl (001 ROUGP)	■	■	■	■	■	■	■	■
Crystal Pearlescent White Pearl (001 PEWHP)	■	■	■	■	■	■	■	■

5817 Crystal Cabochon Pearl

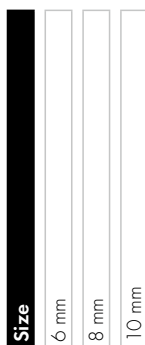
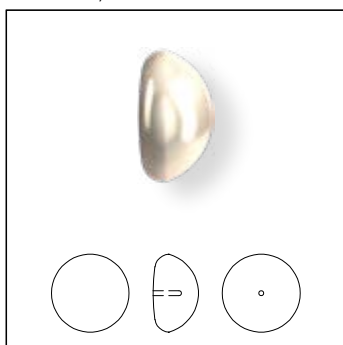

Pearl Colors

- Crystal Bronze Pearl (001 BRPRL)
- Crystal Cream Pearl (001 CRM)
- Crystal Creamrose Light Pearl (001 CRLT)
- Crystal Creamrose Pearl (001 CRMRL)
- Crystal Dark Grey Pearl (001 DGREY)
- Crystal Light Grey Pearl (001 LGREY)
- Crystal Moonlight Pearl (001 MOONP)
- Crystal Peach Pearl (001 PEPRL)
- Crystal Rosaline Pearl (001 ROPRL)
- Crystal Rose Gold Pearl (001 RGPRL)
- Crystal White Pearl (001 WHITE)

Pearl Gemcolors

- Crystal Mystic Black Pearl (001 MBPRL)

Iridescent Pearl Colors

- Crystal Iridescent Dark Blue Pearl (001 IDBLP)
- Crystal Irid. Dark Turquoise Pearl (001 IDTUP)
- Crystal Iridescent Dove Grey Pearl (001 IDGYP)
- Crystal Iridescent Dreamy Blue (001 IDRBP)
- Crystal Iridescent Dreamy Rose (001 IDROP)
- Crystal Iridescent Green Pearl (001 IGPRL)
- Crystal Iridescent Light Blue Pearl (001 ILBLP)
- Crystal Irid. Light Turquoise Pearl (001 ILTUP)
- Crystal Iridescent Rouge Pearl (001 ROUGP)
- Crystal Pearlescent White Pearl (001 PEWHP)

5818 Crystal Half Hole Pearl



Size	3 mm	4 mm	5 mm	6 mm	8 mm	10 mm	12 mm
------	------	------	------	------	------	-------	-------

Pearl Colors	
Crystal Black Pearl (001 BLPRL)	■
Crystal Bright Gold Pearl (001 BGPRL)	■
Crystal Cream Pearl (001 CRM)	■
Crystal Creamrose Light Pearl (001 CRLT)	■
Crystal Creamrose Pearl (001 CRMR)	■
Crystal Dark Grey Pearl (001 DGREY)	■
Crystal Gold Pearl (001 GOPRL)	■
Crystal Grey Pearl (001 GRPRL)	■
Crystal Lavender Pearl (001 LAPRL)	■
Crystal Light Gold Pearl (001 LGPRL)	■
Crystal Light Grey Pearl (001 LGREY)	■
Crystal Moonlight Pearl (001 MOONP)	■
Crystal Peach Pearl (001 PEPRL)	■
Crystal Rosaline Pearl (001 ROPRL)	■
Crystal Rose Gold Pearl (001 RGPRL)	■
Crystal Royal Gold Pearl (001 ROYGP)	■
Crystal White Pearl (001 WHITE)	■
Pearl Gemcolors	
Crystal Mystic Black Pearl (001 MBPRL)	■
Iridescent Pearl Colors	
Crystal Iridescent Dark Blue Pearl (001 IDBLP)	■
Crystal Irid. Dark Turquoise Pearl (001 IDTUP)	■
Crystal Irid. Dove Grey Pearl (001 IDGYP)	■
Crystal Iridescent Light Blue Pearl (001 ILBLP)	■
Crystal Irid. Light Turquoise Pearl (001 ILTUP)	■
Crystal Iridescent Rouge Pearl (001 ROUGP)	■
Crystal Pearlescent White Pearl (001 PEWHP)	■

5821 Crystal Pear-shaped Pearl

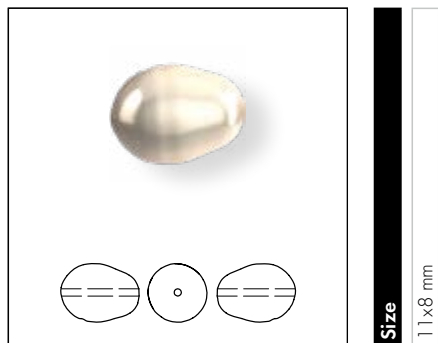

- Pearl Colors**
- Crystal Cream Pearl (001 CRM)
 - Crystal Creamrose Light Pearl (001 CRLT)
 - Crystal Creamrose Pearl (001 CRMR)
 - Crystal Light Grey Pearl (001 LGREY)
 - Crystal Moonlight Pearl (001 MOONP)
 - Crystal Rosaline Pearl (001 ROPRL)
 - Crystal White Pearl (001 WHITE)

5824 Crystal Rice Shape Pearl

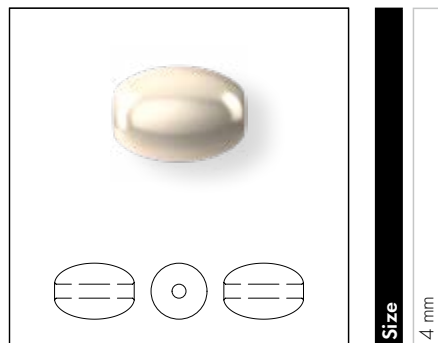

- Pearl Colors**
- Crystal Cream Pearl (001 CRM)
 - Crystal Creamrose Light Pearl (001 CRLT)
 - Crystal Creamrose Pearl (001 CRMR)
 - Crystal Gold Pearl (001 GOPRL)
 - Crystal Light Gold Pearl (001 LGPRL)
 - Crystal Rosaline Pearl (001 ROPRL)
 - Crystal Royal Gold Pearl (001 ROYGP)
 - Crystal White Pearl (001 WHITE)
- Iridescent Pearl Colors**
- Crystal Irid. Dark Turquoise Pearl (001 IDTUP)
 - Crystal Irid. Light Turquoise Pearl (001 ILTUP)

5841 Crystal Baroque Round Pearl

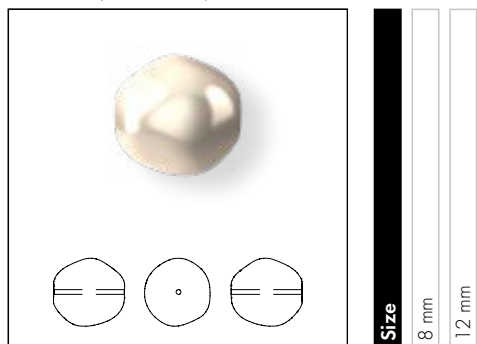

- Pearl Colors**
- Crystal Cream Pearl (001 CRM)
 - Crystal Creamrose Light Pearl (001 CRLT)
 - Crystal Creamrose Pearl (001 CRMR)
 - Crystal Dark Grey Pearl (001 DGREY)
 - Crystal Rosaline Pearl (001 ROPRL)
 - Crystal White Pearl (001 WHITE)

5842 Crystal Baroque Coin Pearl

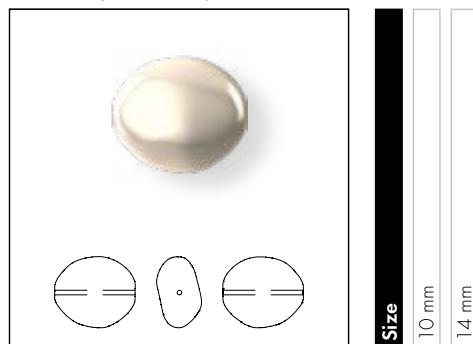

- Pearl Colors**
- Crystal Cream Pearl (001 CRM)
 - Crystal Creamrose Light Pearl (001 CRLT)
 - Crystal Creamrose Pearl (001 CRMR)
 - Crystal Dark Grey Pearl (001 DGREY)
 - Crystal Rosaline Pearl (001 ROPRL)
 - Crystal White Pearl (001 WHITE)

5843 Crystal Baroque Drop Pearl

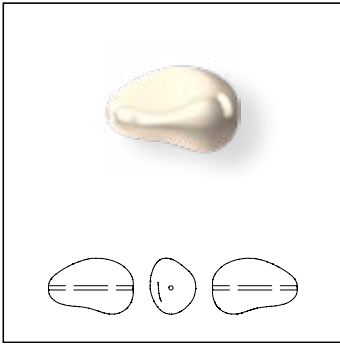

Pearl Colors

- Crystal Cream Pearl (001 CRM)
- Crystal Creamrose Light Pearl (001 CRLT)
- Crystal Creamrose Pearl (001 CRMR)
- Crystal Dark Grey Pearl (001 DGREY)
- Crystal Rosaline Pearl (001 ROPRL)
- Crystal White Pearl (001 WHITE)

5844 Crystal Baroque Elongated Pearl

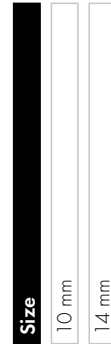
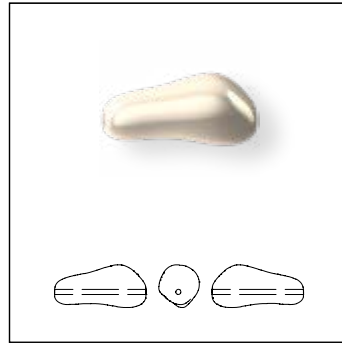

Pearl Colors

- Crystal Cream Pearl (001 CRM)
- Crystal Creamrose Light Pearl (001 CRLT)
- Crystal Creamrose Pearl (001 CRMR)
- Crystal Dark Grey Pearl (001 DGREY)
- Crystal Rosaline Pearl (001 ROPRL)
- Crystal White Pearl (001 WHITE)

5860 Crystal Coin Pearl

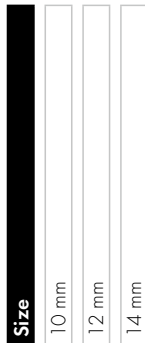
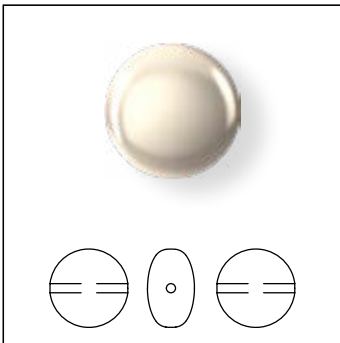

Pearl Colors

- Crystal Cream Pearl (001 CRM)
- Crystal White Pearl (001 WHITE)

Product Details

Article Size	Packing Unit = Minimum Order Quantity in Pieces	Average Net Weight in Gram per Packing Unit Crystal (001)	Average Gross Weight in Gram per Packing Unit Crystal (001)
5809			
1 mm	3,000	4.3	14.8
1.5 mm	2,000	8.5	18.8
2 mm	1,500	20.4	30.4
2.5 mm	1,000	23.9	34.4
3 mm	1,000	36.6	46.4
3.5 mm	1,000	60.3	70.9
5810			
2 mm	1,000	10.2	23.3
3 mm	1,000	38.5	53.5
4 mm	500	38.1	53.6
5 mm	500	83.7	99.2
6 mm	500	142.3	157.8
8 mm	250	173.7	188.9
10 mm	100	110.5	123.9
12 mm	100	191.7	205.1
5817			
6 mm	250	35.8	49.3
8 mm	250	97.9	111.2
10 mm	250	195.6	203.9
5818			
3 mm	1,000	42.0	52.0
4 mm	500	41.9	55.4
5 mm	500	87.9	101.4
6 mm	500	146.5	160.0
8 mm	250	177.9	191.1
10 mm	100	112.2	125.6
12 mm	100	187.5	200.9
5821			
11x8 mm	250	242.5	253.0
5824			
4 mm	500	28.0	42.0
5841			
8 mm	250	164.5	178.5
12 mm	100	210.8	224.8
5842			
10 mm	250	164.5	178.5
14 mm	100	182.9	196.9
5843			
12 mm	250	195.8	209.8
16 mm	100	179.7	193.6
5844			
10 mm	250	87.3	101.3
14 mm	100	80.8	94.8
5860			
10 mm	100	91.5	103.5
12 mm	100	155.6	167.6
14 mm	50	123.0	135.0



















Pendants

















The epitome of elegance and artistry, our Pendants captivate with their exquisite craftsmanship and radiant appeal. Available in a stunning array of classic and contemporary cuts, every Pendant miraculously transforms any design. Meticulously crafted in a spectrum of mesmerizing colors and effects, they invite limitless imagination.

Elevating any design, their flawless surfaces and precision-cut facets reflect light with dazzling brilliance, ensuring a luminous sparkle from every angle. With their ease of application, whether suspended from a delicate chain, woven into intricate jewelry designs, or paired with other Crystal Components, they exude luxury, refinement, and enduring beauty – making each Pendant not just an accessory, but a work of art.







Colors & Effects

Colors



-  Crystal
001
-  Light Rose
223
-  Rose Peach
262
-  Padparadscha
542
-  Rose
209
-  Fuchsia
502
-  Light Siam
227
-  Scarlet
276
-  Siam
208
-  Ruby
501
-  Amethyst
204
-  Iris
219
-  Light Amethyst
212
-  Violet
371
-  Tanzanite
539
-  Aquamarine
202
-  Light Sapphire
211

-  Sapphire
206
-  Capri Blue
243
-  Majestic Blue
296
-  Montana
207
-  Denim Blue
266
-  Light Turquoise
263
-  Blue Zircon
229
-  Erinite
360
-  Citrus Green
337
-  Fern Green
291
-  Majestic Green
336
-  Emerald
205
-  Jonquil
213
-  Light Topaz
226
-  Light Colorado Topaz
246
-  Topaz
203
-  Jet
280

Swarovski ReCreated™ Colors

-  ReCreated™ Ice Blue
1405
-  ReCreated™ Dark Sapphire*
1404
-  ReCreated™ Peridot
1408
-  ReCreated™ Dark Jonquil*
1407
-  ReCreated™ Light Smoked Topaz*
1402
-  ReCreated™ Smoked Topaz*
1403

TCF™ Colors

-  Dark Rose*
1201 TCF™
-  Dark Orange*
1202 TCF™

Colors & Effects

*this color does not exist for 6228, but for other Pendants. For more details, please see the product matrix on the respective items.









Effects

-  Crystal Moonlight
001 MOL
-  Crystal Shimmer
001 SHIM
-  Crystal Aurore Boreale
001 AB
-  Crystal Antique Pink
001 ANTP
-  Crystal Vitrail Light
001 VL
-  Crystal Paradise Shine
001 PARSH
-  Crystal Vitrail Medium
001 VM
-  Crystal Heliotrope
001 HEL
-  Crystal Bermuda Blue
001 BBL
-  Crystal Blue Shade
001 BLSH
-  Crystal Golden Shadow
001 GSHA
-  Crystal Aurum
001 AUR2
-  Crystal Light Chrome
001 LTCH
-  Crystal Silver Shade
001 SSHA
-  Crystal Silver Night
001 SINI

AB Effects

-  Light Rose Aurore Boreale
223 AB
-  Rose Aurore Boreale
209 AB
-  Fuchsia Aurore Boreale
502 AB
-  Light Siam Aurore Boreale
227 AB
-  Siam Aurore Boreale
208 AB
-  Violet Aurore Boreale
371 AB
-  Aquamarine Aurore Boreale
202 AB
-  Sapphire Aurore Boreale
206 AB
-  Blue Zircon Aurore Boreale
229 AB
-  Light Topaz Aurore Boreale
226 AB

Shimmer Effects

-  Light Rose Shimmer
223 SHIM
-  Light Siam Shimmer
227 SHIM
-  Amethyst Shimmer
204 SHIM
-  Light Amethyst Shimmer
212 SHIM
-  Aquamarine Shimmer
202 SHIM
-  Light Sapphire Shimmer
211 SHIM
-  Emerald Shimmer
205 SHIM
-  Light Topaz Shimmer
226 SHIM

Numerical Order

001	Crystal	206	Sapphire	262	Rose Peach
001 AB	Crystal Aurore Boreale	207	Montana	263	Light Turquoise
001 ANTP	Crystal Antique Pink	208 AB	Siam Aurore Boreale	266	Denim Blue
001 AUR	Crystal Aurum	208	Siam	276	Scarlet
001 BBL	Crystal Bermuda Blue	209 AB	Rose Aurore Boreale	280	Jet
001 BLSH	Crystal Blue Shade	209	Rose	291	Fern Green
001 GSHA	Crystal Golden Shadow	211 SHIM	Light Sapphire Shimmer	296	Majestic Blue
001 HEL	Crystal Heliotrope	211	Light Sapphire	336	Majestic Green
001 LTCH	Crystal Light Chrome	212 SHIM	Light Amethyst Shimmer	337	Citrus Green
001 MOL	Crystal Moonlight	212	Light Amethyst	360	Erinite
001 PARSH	Crystal Paradise Shine	213	Jonquil	371 AB	Violet Aurore Boreale
001 SHIM	Crystal Shimmer	219	Iris	371	Violet
001 SINI	Crystal Silver Night	223 AB	Light Rose Aurore Boreale	501	Ruby
001 SSHA	Crystal Silver Shade	223 SHIM	Light Rose Shimmer	502 AB	Fuchsia Aurore Boreale
001 VL	Crystal Vitrail Light	223	Light Rose	502	Fuchsia
001 VM	Crystal Vitrail Medium	226 AB	Light Topaz Aurore Boreale	539	Tanzanite
202 AB	Aquamarine Aurore Boreale	226 SHIM	Light Topaz Shimmer	542	Padparadscha
202 SHIM	Aquamarine Shimmer	226	Light Topaz	1201 TCF™	Dark Rose
202	Aquamarine	227 AB	Light Siam Aurore Boreale	1202 TCF™	Dark Orange
203	Topaz	227 SHIM	Light Siam Shimmer	1402	ReCreated™ Light Smoked Topaz
204	Amethyst	227	Light Siam	1403	ReCreated™ Smoked Topaz
204 SHIM	Amethyst Shimmer	229 AB	Blue Zircon Aurore Boreale	1404	ReCreated™ Dark Sapphire
205 SHIM	Emerald Shimmer	229	Blue Zircon	1405	ReCreated™ Ice Blue
205	Emerald	243	Capri Blue	1407	ReCreated™ Dark Jonquil
206 AB	Sapphire Aurore Boreale	246	Light Colorado Topaz	1408	ReCreated™ Peridot

Alphabetical Order

Amethyst (204)	Dark Orange (1202 TCF™)	Light Topaz Shimmer (226 SHIM)
Amethyst Shimmer (204 SHIM)	Dark Rose (1201 TCF™)	Light Turquoise (263)
Aquamarine (202)	Denim Blue (266)	Majestic Blue (296)
Aquamarine Aurore Boreale (202 AB)	Emerald (205)	Majestic Green (336)
Aquamarine Shimmer (202 SHIM)	Emerald Shimmer (205 SHIM)	Montana (207)
Blue Zircon (229)	Erinite (360)	Padparadscha (542)
Blue Zircon Aurore Boreale (229 AB)	Fern Green (291)	ReCreated™ Dark Jonquil (1407)
Capri Blue (243)	Fuchsia (502)	ReCreated™ Dark Sapphire (1404)
Citrus Green (337)	Fuchsia Aurore Boreale (502 AB)	ReCreated™ Ice Blue (1405)
Crystal (001)	Iris (219)	ReCreated™ Light Smoked Topaz (1402)
Crystal Antique Pink (001 ANTP)	Jet (280)	ReCreated™ Peridot (1408)
Crystal Aurore Boreale (001 AB)	Jonquil (213)	ReCreated™ Smoked Topaz (1403)
Crystal Aurum (001 AUR)	Light Amethyst (212)	Rose (209)
Crystal Bermuda Blue (001 BBL)	Light Amethyst Shimmer (212 SHIM)	Rose Aurore Boreale (209 AB)
Crystal Blue Shade (001 BLSH)	Light Colorado Topaz (246)	Rose Peach (262)
Crystal Golden Shadow (001 GSHA)	Light Rose (223)	Ruby (501)
Crystal Heliotrope (001 HEL)	Light Rose Aurore Boreale (223 AB)	Sapphire (206)
Crystal Light Chrome (001 LTCH)	Light Rose Shimmer (223 SHIM)	Sapphire Aurore Boreale (206 AB)
Crystal Moonlight (001 MOL)	Light Sapphire (211)	Scarlet (276)
Crystal Paradise Shine (001 PARSH)	Light Sapphire Shimmer (211 SHIM)	Siam (208)
Crystal Shimmer (001 SHIM)	Light Siam (227)	Siam Aurore Boreale (208 AB)
Crystal Silver Night (001 SINI)	Light Siam Aurore Boreale (227 AB)	Tanzanite (539)
Crystal Silver Shade (001 SSHA)	Light Siam Shimmer (227 SHIM)	Topaz (203)
Crystal Vitrail Light (001 VL)	Light Topaz (226)	Violet (371)
Crystal Vitrail Medium (001 VM)	Light Topaz Aurore Boreale (226 AB)	Violet Aurore Boreale (371 AB)

For details on available colors and effects for each article within the product groups, please see the product matrix of the respective item in the Collection 2026.

































The plating resistance of effects is tested according to Swarovski's plating guidelines (SWAROVSKI.COM/S-PROFESSIONALS). Customers are advised to carry out their own tests if their plating parameters diverge from Swarovski plating guidelines.

Colors and effects can appear different when illuminated with different light sources. Swarovski uses standard light source D65 for color decision and comparison. Slight changes in shades are unavoidable. Colors may vary according to cut and foiling.

The composition of Advanced Crystal is compliant with regulatory industry norms and laws regarding the restriction or prohibition of certain substances in the most relevant segments of our customers. Please note that the compliance of the colors Light Siam and Siam varies according to certain industry regulations. Those regulations are indicated with * in the compliance overview. Indian Siam, Ruby and Scarlet (option to Lt. Siam) conform to all CLEAR-lists. For further information please visit swarovski.com/s-professionals

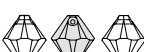
© 2026 D. Swarovski Distribution GmbH

Summary

1 2 3  6000 11x5.5, 13x6.5, 15x7.5, 22x11 mm	1 2 3  6100 24x12 mm	1 2 3  6430 8, 10, 14 mm
 6002 10x7, 15x11.5 mm	 6106 16, 22, 28, 38 mm	 6431 9, 11.5, 16 mm
 6007 7x4, 9x5 mm	 6210 12, 17 mm	 6432 8, 10.5, 14.5 mm
 6010 11x5.5, 13x6.5, 17x8.5, 21x10.5 mm	 6215 18 mm	 6433 9, 11.5, 16 mm
 6015 17, 21 mm	 6225 10, 18, 28 mm	 6434 8, 10.5, 14.5 mm
 6017/G 30, 56 mm	 6228 10.3x10, 14.4x14, 18x17.5, 28, 40 mm	 6435 9, 11.5, 16 mm
 6020 18, 30, 37 mm	 6240 12, 17, 27 mm	 6436 9, 11.5, 16 mm
 6022 14, 24 mm	 6261 17, 27 mm	 6438 9, 11.5, 16 mm
 6040 20, 30, 40 mm	 6264 18, 28 mm	 6480 18, 28, 39 mm
 6049 20, 30 mm	 6328 6, 8 mm	 6565 18, 22 mm
 6090 16x11, 22x15 mm	 6428 6, 8, 12 mm	 6656 19, 27, 39 mm

1 Front view 2 Side view 3 Back view

"1 Front view" or "3 Back view" shaded in gray: surface effect is applied to this side.

"2 Side view" shaded in gray: side of surface effect not defined (for all symmetrical and some asymmetrical articles).

Where all views are shaded in gray, the effect is applied over the entire marked surface.

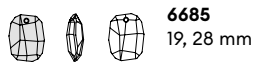
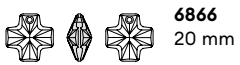
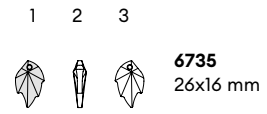
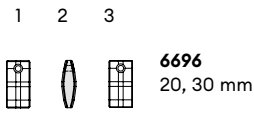
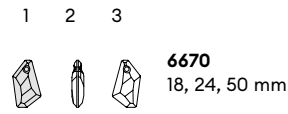

Summary

1 Front view 2 Side view 3 Back view

"1 Front view" or "3 Back view" shaded in gray: the surface effect is applied to this side.

"2 Side view" shaded in gray: side of surface effect not defined (for all symmetrical and some asymmetrical articles).

6721: 16, 20 mm: no defined side for surface effect; 28, 40 mm surface effect on "3 Back view."

6000 Classic Drop Pendant

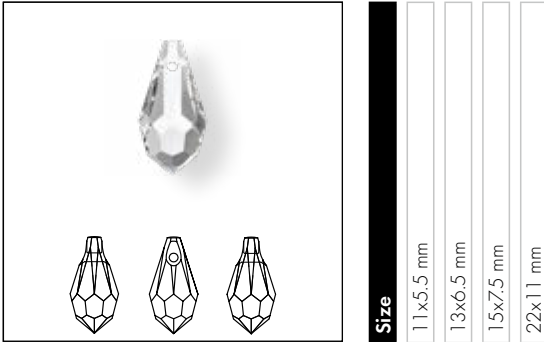

Size
 11x5.5 mm
 13x6.5 mm
 15x7.5 mm
 22x11 mm

Crystal			
Crystal (001)	■	■	■
Colors			
Plain Colors			
Amethyst (204)	■		
Aquamarine (202)	■		
Blue Zircon (229)	■		
Emerald (205)	■		
Jet (280)	■	■	■
Light Amethyst (212)	■		
Light Siam (227)	■		
Majestic Blue (296)	■		
Majestic Green (336)	■		
Rose (209)	■		
Sapphire (206)	■		
Siam (208)	■	■	■
Tanzanite (539)	■		
Topaz (203)	■		
ReCreated™ Colors			
ReCreated™ Ice Blue (1405)	■		
ReCreated™ Peridot (1408)	■		
Crystal Effects			
Transparent Effects			
Crystal Aurore Boreale (001 AB)	■	■	■
Crystal Paradise Shine (001 PARSH)	■		

6002 Oval Disco Pendant

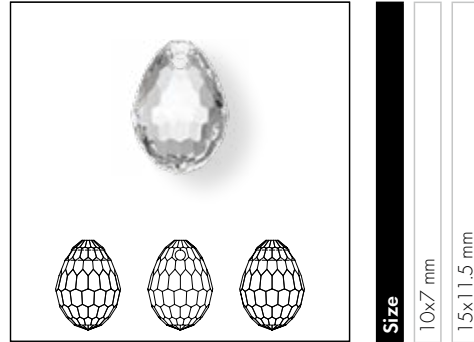

Size
 10x7 mm
 15x11.5 mm

Crystal	
Crystal (001)	■
Crystal Effects	
Transparent Effects	
Crystal Aurore Boreale (001 AB)	■

08

6007 Small Briolette Pendant

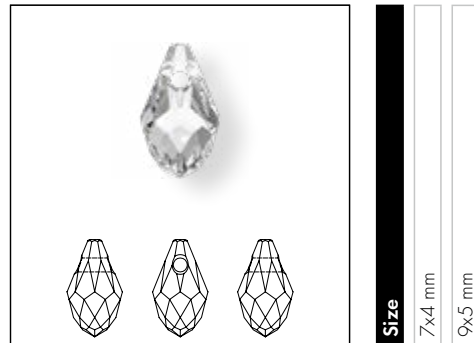

Size
 7x4 mm
 9x5 mm

Crystal	
Crystal (001)	■
Crystal Effects	
Transparent Effects	
Crystal Aurore Boreale (001 AB)	■
Crystal Golden Shadow (001 GSHA)	■

6010 Briolette Pendant



Size 11x5.5, 13x6.5, 17x8.5, 21x10.5 mm

6106 Pear-shaped Pendant



Size 16, 22, 28, 38

6228 XILION Heart Pendant

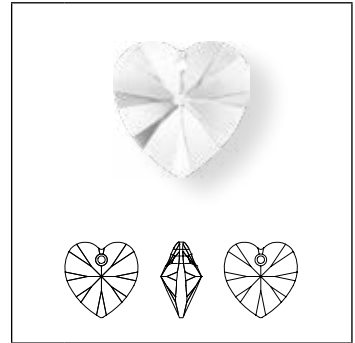

Size 10.3x10, 14.4x14, 18x17.5, 28, 40 mm

6428 XILION Pendant

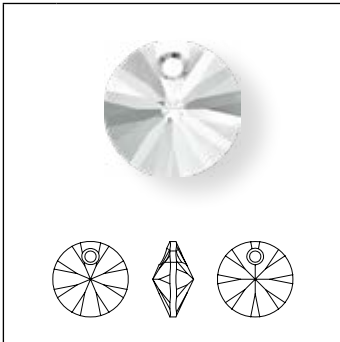

Size 6 mm

6428 XILION Pendant

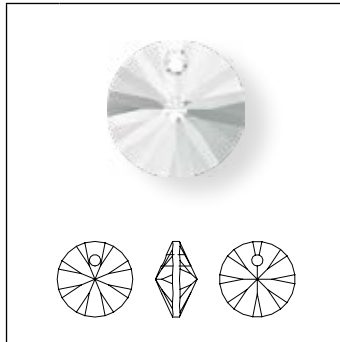

Size 8, 12 mm

6010
6106
6228
6428

Crystal

Crystal (001)

Colors

Plain Colors

Amethyst (204)

Aquamarine (202)

Blue Zircon (229)

Denim Blue (266)

Citrus Green (337)

Size	6010 Briolette Pendant	6106 Pear-shaped Pendant	6228 XILION Heart Pendant	6428 XILION Pendant
11x5.5 mm	■			
13x6.5 mm	■			
17x8.5 mm	■			
21x10.5 mm	■			
16 mm		■		
22 mm		■		
28 mm		■		
38 mm		■		
10.3x10 mm			■	
14.4x14 mm			■	
18x17.5 mm			■	
28 mm			■	
40 mm			■	
6 mm				■
8 mm				■
12 mm				■

<p>6010 6106 6228 6428</p>		Size	6010 Briollette Pendant				6106 Pear-shaped Pendant				6228 XILLION Heart Pendant				6428 XILLION Pendant		
			11x5.5 mm	13x6.5 mm	17x8.5 mm	21x10.5 mm	16 mm	22 mm	28 mm	38 mm	10.3x10 mm	14.4x14 mm	18x17.5 mm	28 mm	40 mm	6 mm	8 mm
Emerald (205)			■	■	■		■	■	■		■	■	■		■	■	■
Erinite (360)			■	■													
Fern Green (291)																	
Fuchsia (502)			■	■							■	■					
Iris (219)			■	■											■	■	■
Jet (280)			■	■			■	■	■						■	■	■
Light Amethyst (212)			■	■			■	■			■	■	■				
Light Colorado Topaz (246)			■	■													
Light Rose (223)			■	■	■		■	■	■		■	■	■		■	■	■
Light Sapphire (211)							■	■									
Light Siam (227)							■				■	■	■		■	■	
Light Topaz (226)			■	■							■	■					
Light Turquoise (263)			■	■											■	■	
Majestic Green (336)			■	■							■	■					
Padparadscha (542)			■	■													
Rose (209)			■	■				■			■	■	■		■	■	
Rose Peach (262)			■	■			■										
Ruby (501)							■	■									
Sapphire (206)							■	■			■	■			■	■	
Scarlet (276)			■	■	■		■	■	■		■	■	■		■	■	■
Siam (208)			■	■							■	■	■		■	■	
Tanzanite (539)			■	■	■		■	■									
Violet (371)											■	■			■	■	
Swarovski ReCreated™ Colors																	
ReCreated™ Dark Jonquil (1407)			■	■													
ReCreated™ Dark Sapphire (1404)			■	■											■	■	
ReCreated™ Ice Blue (1405)			■	■			■	■			■	■			■	■	
ReCreated™ light Smoked Topaz (1402)			■	■			■	■									
ReCreated™ Peridot (1408)			■	■			■	■			■	■			■	■	
ReCreated™ Smoked Topaz (1403)			■	■			■	■									
TCF™ Colors																	
Dark Orange (1202 TCF™)			■	■											■	■	
Dark Rose (1201 TCF™)			■	■											■	■	

<p>6010 6106 6228 6428</p>		Size	6010 Briollette Pendant	6106 Pear-shaped Pendant	6228 XILLION Heart Pendant	6428 XILLION Pendant												
			11x5.5 mm	13x6.5 mm	17x8.5 mm	21x10.5 mm	16 mm	22 mm	28 mm	38 mm	10.3x10 mm	14.4x14 mm	18x17.5 mm	28 mm	40 mm	6 mm	8 mm	12 mm
Crystal Effects																		
Transparent Effects																		
Crystal AB (001 AB)			■	■	■	■	■	■	■		■	■	■		■	■	■	■
Crystal Antique Pink (001 ANTP)								■	■							■	■	
Crystal Bermuda Blue (001 BB)											■	■	■					
Crystal Bermuda Blue P (001 BB) ¹														■				
Crystal Blue Shade (001 BLSH)			■	■				■	■							■	■	
Crystal Golden Shadow (001 GSHA)			■	■	■	■		■	■	■		■	■	■		■	■	
Crystal Heliotrope (001 HEL)											■	■	■					
Crystal Paradise Shine (001 PARSH)			■	■				■	■		■	■	■			■	■	
Crystal Shimmer (001 SHIM)								■	■	■		■	■	■		■	■	
Crystal Silver Night (001 SINI)			■	■				■	■	■		■	■	■		■	■	
Crystal Silver Shade (001 SSHA)			■	■				■	■							■	■	
Crystal Vitrail Light (001 VL)											■	■	■					
Crystal Vitrail Medium (001 VM)											■	■	■					
Metallic Effects																		
Crystal Aurum 2x (001 AUR2)								■	■		■					■	■	
Color Effects																		
Transparent Effects																		
Amethyst Shimmer (204 SHIM)								■	■		■	■	■			■	■	
Aquamarine AB (202 AB)											■	■						
Aquamarine Shimmer (202 SHIM)								■	■		■	■	■			■	■	
Blue Zircon AB (229 AB)											■							
Emerald Shimmer (205 SHIM)								■	■									
Fuchsia AB (502 AB)											■							
Light Amethyst Shimmer (212 SHIM)								■	■		■	■	■					
Light Rose AB (223 AB)											■	■						
Light Rose Shimmer (223 SHIM)								■			■	■	■			■	■	
Light Sapphire Shimmer (211 SHIM)								■	■									
Light Siam AB (227 AB)											■							
Light Siam Shimmer (227 SHIM)											■	■				■	■	
Light Topaz AB (226 AB)											■							
Light Topaz Shimmer (226 SHIM)											■							
Rose AB (209 AB)											■	■						
Sapphire AB (206 AB)											■							
Siam AB (208 AB)											■	■	■					
Violet AB (371 AB)											■							

6015 Polygon Drop

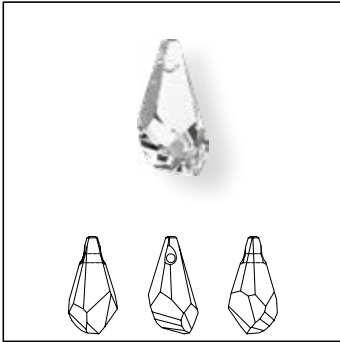

Size	17 mm	21 mm
-------------	-------	-------

Crystal

 Crystal (001)

Crystal Effects

Transparent Effects

 Crystal Aurore Boreale (001 AB)

 Crystal Golden Shadow (001 GSHA)

Maison Margiela for Swarovski

CRYSTALACTITE PENDANTS

Since 1988, Paris-based Maison Margiela has become famous for its collaborative team-led approach and its avant-garde transformation of classic designs. In July 2013, it presented the Maison Margiela Crystalactite for Swarovski at its Paris Haute Couture show. These were groundbreaking Crystal Fusion components inspired by natural stalactite forms and developed in creative partnership with Swarovski. Swarovski presents its interpretation of this innovative cut in pure crystalline form – the Crystalactite Pendant. Featuring a progressive

aesthetic combining partly frosted facets with primeval, irregular icicle shapes, the vision that originated in our wildest landscapes has been perfected by one of the most sophisticated design houses. With an easy-to-use hole at the top, the Pendant offers myriad design possibilities for strong, contemporary designs, and for recreating haute-couture looks.

“Naturally and spontaneously, an imposing crystal emerges from its raw, stony origin, patiently growing into its iconic stalactite shape.”

6017/G Crystalactite Pendant grand partly frosted

	30 mm	56 mm
Crystal		
Crystal (001)	■	■
Crystal Effects		
Transparent Effects		
Crystal Aurore Boreale V (001 ABV)	■	■
Crystal Bermuda Blue P (001 BB)	■	■
Crystal Golden Shadow V (001 GSHAV)	■	■
Crystal Vitrail Medium P (001 VM)	■	■

6020 Helix Pendant

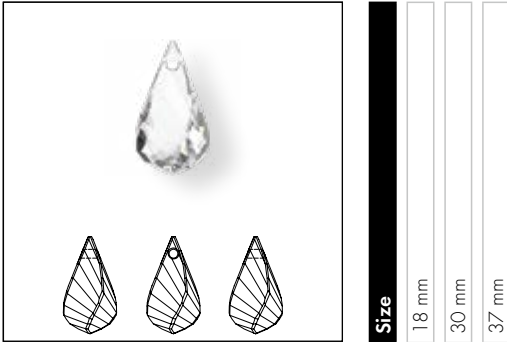

Size
18 mm
30 mm
37 mm

Crystal

Crystal (001)

Crystal Effects

Transparent Effects

Crystal Aurore Boreale (001 AB)

Crystal Golden Shadow (001 GSHA)

6022 XIRIUS Raindrop Pendant

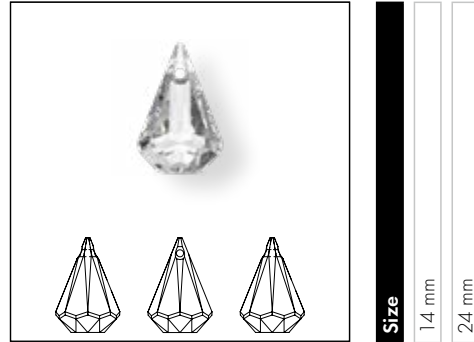

Size
14 mm
24 mm

Crystal

Crystal (001)

Crystal Effects

Transparent Effects

Crystal Aurore Boreale (001 AB)

6040 Helios Pendant

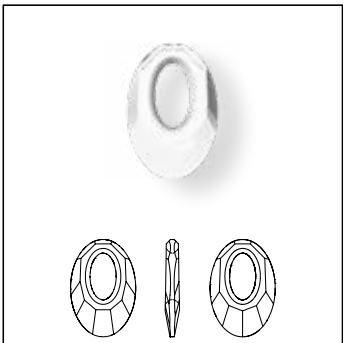

Size
20 mm
30 mm
40 mm

Crystal

Crystal (001)

Crystal Effects

Transparent Effects

Crystal Aurore Boreale (001 AB)

Crystal Silver Night (001 SINI)

6049 Flat Disc Pendant

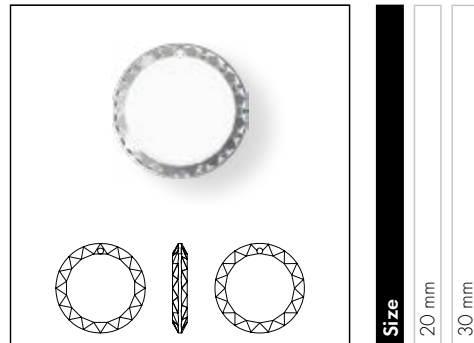

Size
20 mm
30 mm

Crystal

Crystal (001)

6090 Baroque Pendant

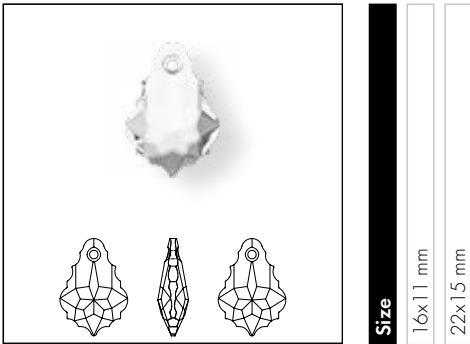

Size

16x11 mm

22x15 mm

Crystal

Crystal (001)

Colors

Plain Colors

Jet (280)

Ruby (501)

Crystal Effects

Transparent Effects

Crystal Aurore Boreale (001 AB)

Crystal Bermuda Blue (001 BB)

Crystal Golden Shadow (001 GSHA)

Crystal Vitrail Light (001 VL)

6100 Elegant Pendant

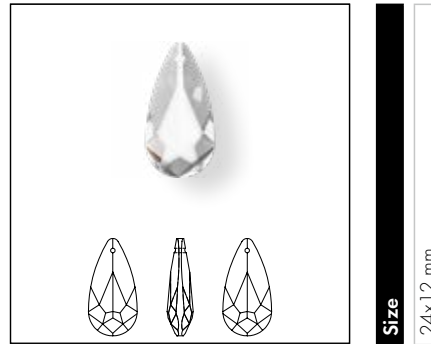

Size

24x12 mm

Crystal

Crystal (001)

Crystal Effects

Transparent Effects

Crystal Aurore Boreale (001 AB)

Crystal Bermuda Blue (001 BB)

Crystal Vitrail Light (001 VL)

Crystal Vitrail Medium (001 VM)

6210 Lunar Pendant

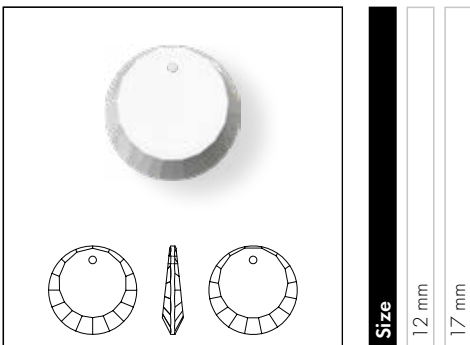

Size

12 mm

17 mm

Crystal

Crystal (001)

Crystal Effects

Transparent Effects

Crystal Aurore Boreale (001 AB)

6215 Classic Heart Pendant

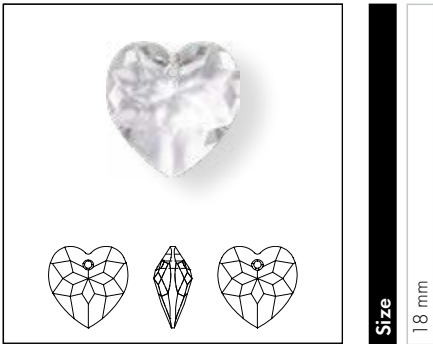

Size
18 mm

Crystal

Crystal (001)

Crystal Effects

Transparent Effects

Crystal Aurore Boreale (001 AB)

Crystal Bermuda Blue P (001 BB)

Crystal Vitrail Light (001 VL)

6225 Flat Heart Pendant

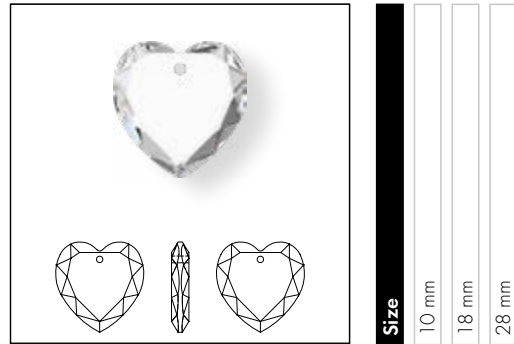

Size
10 mm
18 mm
28 mm

Crystal

Crystal (001)

6240 Wild Heart Pendant

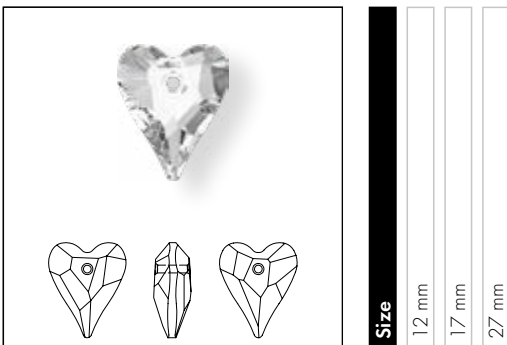

Size
12 mm
17 mm
27 mm

Crystal

Crystal (001)

Crystal Effects

Transparent Effects

Crystal Aurore Boreale (001 AB)

”Love Story of the Heart“ by Manish Arora

Since the beginning of his international career, the award-winning, Delhi-based designer Manish Arora has worked creatively with Swarovski. In 2009, he created a memorable collection of crystalline Transfers. One year later, India's best-loved and most prolific design talent renewed his partnership with Swarovski and created a special collection of heart-shaped Pendants, which were launched in February 2011. Each individual piece is an expression of love's different emotional states and is named accordingly.

The partnership with Manish Arora is symbolic of how Swarovski engages in mutually rewarding creative partnerships with the world's best and brightest design spirits.

“The heart shape is very close to me because it is the universal symbol of love. I wanted to bring this symbol to life by creating a collection of crystal pendants and I hope people will wear them as a personal expression of the beauty and purity of this emotion.” Manish Arora

6261 Devoted 2 U Heart

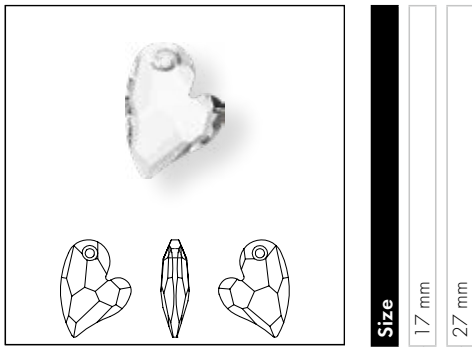

Crystal	
Crystal (001)	
Crystal Effects	
Transparent Effects	
Crystal Aurore Boreale (001 AB)	

6264 Truly in Love Heart

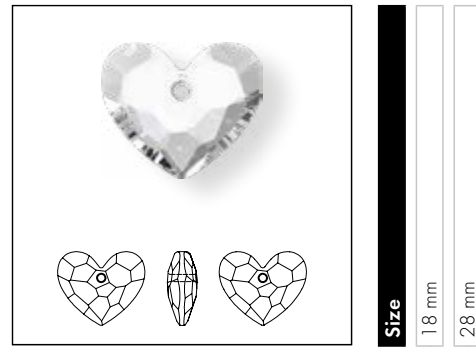

Crystal	
Crystal (001)	
Crystal Effects	
Transparent Effects	
Crystal Aurore Boreale (001 AB)	
Crystal Bermuda Blue P (001 BB)	

6328 XILION Bi-Cone Pendant



Crystal	
Crystal (001)	<input type="checkbox"/>
Colors	
Plain Colors	
Aquamarine (202)	<input type="checkbox"/>
Light Rose (223)	<input type="checkbox"/>
Violet (371)	<input type="checkbox"/>
Crystal Effects	
Transparent Effects	
Crystal Aurore Boreale (001 AB)	<input type="checkbox"/>
Crystal Golden Shadow (001 GSHA)	<input type="checkbox"/>

6430 Classic Cut Pendant

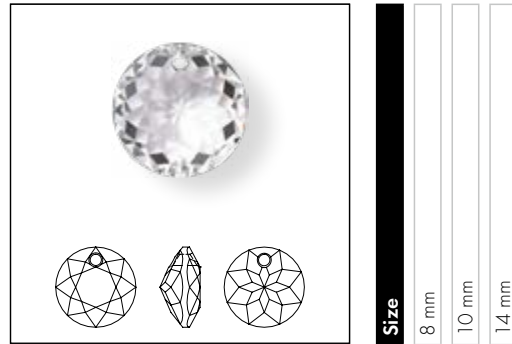

Crystal	
Crystal (001)	<input type="checkbox"/>
Colors	
Plain Colors	
Aquamarine (202)	<input type="checkbox"/>
Emerald (205)	<input type="checkbox"/>
Light Amethyst (212)	<input type="checkbox"/>
Majestic Green (336)	<input type="checkbox"/>
Montana (207)	<input type="checkbox"/>
Rose (209)	<input type="checkbox"/>
Sapphire (206)	<input type="checkbox"/>
Scarlet (276)	<input type="checkbox"/>
Siam (208)	<input type="checkbox"/>
ReCreated™ Colors	
ReCreated™ Peridot (1408)	<input type="checkbox"/>
Crystal Effects	
Transparent Effects	
Crystal Aurore Boreale (001 AB)	<input type="checkbox"/>
Crystal Bermuda Blue P (001 BB)	<input type="checkbox"/>
Crystal Golden Shadow (001 GSHA)	<input type="checkbox"/>
Crystal Shimmer (001 SHIM)	<input type="checkbox"/>
Crystal Silver Night (001 SINI)	<input type="checkbox"/>
Crystal Vitrail Light P (001 VL)	<input type="checkbox"/>
Crystal Vitrail Medium P (001 VM)	<input type="checkbox"/>
Color Effects	
Transparent Effects	
Aquamarine Shimmer (202 SHIM)	<input type="checkbox"/>
Light Rose Shimmer (223 SHIM)	<input type="checkbox"/>

6431 Princess Cut Pendant

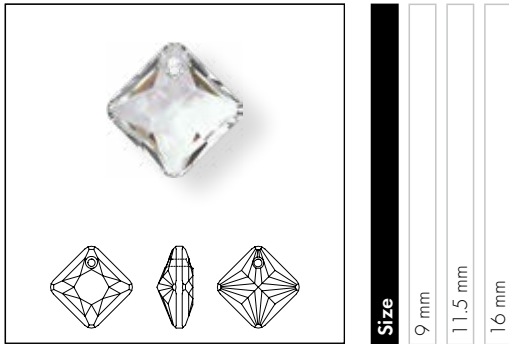

Size
9 mm
11.5 mm
16 mm

Crystal		9 mm	11.5 mm	16 mm
Crystal (001)	<input type="checkbox"/>	<input type="checkbox"/>	<input type="checkbox"/>	<input type="checkbox"/>
Crystal Effects				
Transparent Effects				
Crystal Aurore Boreale (001 AB)	<input type="checkbox"/>	<input type="checkbox"/>	<input type="checkbox"/>	<input type="checkbox"/>
Crystal Bermuda Blue P (001 BB)	<input type="checkbox"/>	<input type="checkbox"/>	<input type="checkbox"/>	<input type="checkbox"/>
Crystal Golden Shadow (001 GSHA)	<input type="checkbox"/>	<input type="checkbox"/>	<input type="checkbox"/>	<input type="checkbox"/>
Crystal Shimmer (001 SHIM)	<input type="checkbox"/>	<input type="checkbox"/>	<input type="checkbox"/>	<input type="checkbox"/>
Crystal Silver Night (001 SINI)	<input type="checkbox"/>	<input type="checkbox"/>	<input type="checkbox"/>	<input type="checkbox"/>
Crystal Vitrail Light P (001 VL)	<input type="checkbox"/>	<input type="checkbox"/>	<input type="checkbox"/>	<input type="checkbox"/>
Crystal Vitrail Medium P (001 VM)	<input type="checkbox"/>	<input type="checkbox"/>	<input type="checkbox"/>	<input type="checkbox"/>

6432 Heart Cut Pendant

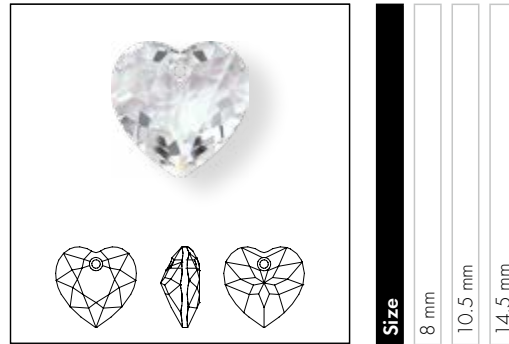

Size
8 mm
10.5 mm
14.5 mm

Crystal		8 mm	10.5 mm	14.5 mm
Crystal (001)	<input type="checkbox"/>	<input type="checkbox"/>	<input type="checkbox"/>	<input type="checkbox"/>
Colors				
Plain Colors				
Amethyst (204)	<input type="checkbox"/>	<input type="checkbox"/>	<input type="checkbox"/>	<input type="checkbox"/>
Aquamarine (202)	<input type="checkbox"/>	<input type="checkbox"/>	<input type="checkbox"/>	<input type="checkbox"/>
Light Rose (223)	<input type="checkbox"/>	<input type="checkbox"/>	<input type="checkbox"/>	<input type="checkbox"/>
Light Siam (227)	<input type="checkbox"/>	<input type="checkbox"/>	<input type="checkbox"/>	<input type="checkbox"/>
Rose (209)	<input type="checkbox"/>	<input type="checkbox"/>	<input type="checkbox"/>	<input type="checkbox"/>
Scarlet (276)	<input type="checkbox"/>	<input type="checkbox"/>	<input type="checkbox"/>	<input type="checkbox"/>
Crystal Effects				
Transparent Effects				
Crystal Aurore Boreale (001 AB)	<input type="checkbox"/>	<input type="checkbox"/>	<input type="checkbox"/>	<input type="checkbox"/>
Crystal Bermuda Blue P (001 BB)	<input type="checkbox"/>	<input type="checkbox"/>	<input type="checkbox"/>	<input type="checkbox"/>
Crystal Golden Shadow (001 GSHA)	<input type="checkbox"/>	<input type="checkbox"/>	<input type="checkbox"/>	<input type="checkbox"/>
Crystal Shimmer (001 SHIM)	<input type="checkbox"/>	<input type="checkbox"/>	<input type="checkbox"/>	<input type="checkbox"/>
Crystal Silver Night (001 SINI)	<input type="checkbox"/>	<input type="checkbox"/>	<input type="checkbox"/>	<input type="checkbox"/>
Crystal Vitrail Light P (001 VL)	<input type="checkbox"/>	<input type="checkbox"/>	<input type="checkbox"/>	<input type="checkbox"/>
Crystal Vitrail Medium P (001 VM)	<input type="checkbox"/>	<input type="checkbox"/>	<input type="checkbox"/>	<input type="checkbox"/>
Color Effects				
Transparent Effects				
Aquamarine Shimmer (202 SHIM)	<input type="checkbox"/>	<input type="checkbox"/>	<input type="checkbox"/>	<input type="checkbox"/>
Light Rose Shimmer (223 SHIM)	<input type="checkbox"/>	<input type="checkbox"/>	<input type="checkbox"/>	<input type="checkbox"/>

6433 Pear Cut Pendant

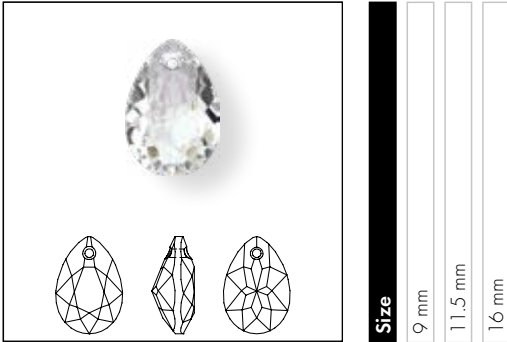

Size
9 mm
11.5 mm
16 mm

- Crystal**
- Crystal (001)
- Crystal Effects**
- Transparent Effects**
- Crystal Aurore Boreale (001 AB)
- Crystal Bermuda Blue P (001 BB)
- Crystal Golden Shadow (001 GSHA)
- Crystal Shimmer (001 SHIM)
- Crystal Silver Night (001 SINI)
- Crystal Vitrail Light P (001 VL)
- Crystal Vitrail Medium P (001 VM)
- Color Effects**
- Transparent Effects**
- Aquamarine Shimmer (202 SHIM)

6434 Trilliant Cut Pendant



Size
8 mm
10.5 mm
14.5 mm

- Crystal**
- Crystal (001)
- Colors**
- Plain Colors**
- Aquamarine (202)
- Blue Zircon (229)
- Citrus Green (337)
- Sapphire (206)
- Scarlet (276)
- ReCreated™ Colors**
- ReCreated™ Peridot (1408)
- Crystal Effects**
- Transparent Effects**
- Crystal Aurore Boreale (001 AB)
- Crystal Bermuda Blue P (001 BB)
- Crystal Golden Shadow (001 GSHA)
- Crystal Shimmer (001 SHIM)
- Crystal Silver Night (001 SINI)
- Crystal Vitrail Light P (001 VL)
- Crystal Vitrail Medium P (001 VM)

6435 Emerald Cut Pendant

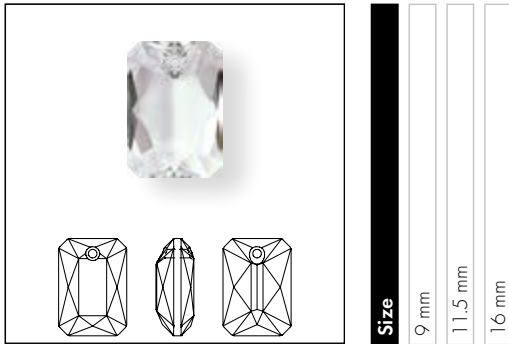

Crystal		9 mm	11.5 mm	16 mm
Crystal (001)		■	■	■
Crystal Effects				
Transparent Effects				
Crystal Aurore Boreale (001 AB)		■	■	■
Crystal Bermuda Blue P (001 BB)		■	■	■
Crystal Golden Shadow (001 GSHA)		■	■	■
Crystal Shimmer (001 SHIM)		■	■	■
Crystal Silver Night (001 SINI)		■	■	■
Crystal Vitrail Light P (001 VL)		■	■	■
Crystal Vitrail Medium P (001 VM)		■	■	■

6436 Majestic Pendant

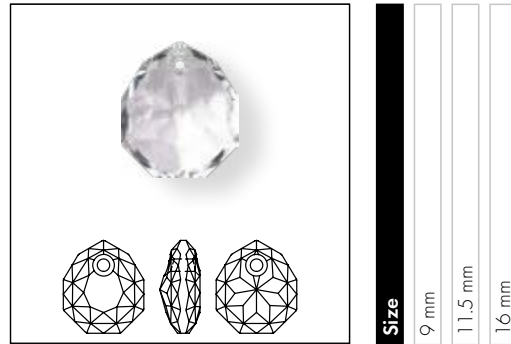

Crystal		9 mm	11.5 mm	16 mm
Crystal (001)		■	■	■
Colors				
Plain Colors				
Aquamarine (202)		■	■	■
Blue Zircon (229)		■	■	■
Citrus Green (337)		■	■	■
Emerald (205)		■	■	■
Light Amethyst (212)		■	■	■
Light Rose (223)		■	■	■
Majestic Green (336)		■	■	■
Rose (209)		■	■	■
Sapphire (206)		■	■	■
Scarlet (276)		■	■	■
ReCreated™ Colors				
ReCreated™ Ice Blue (1405)		■	■	■
ReCreated™ Peridot (1408)		■	■	■
Crystal Effects				
Transparent Effects				
Crystal Aurore Boreale (001 AB)			■	■
Crystal Bermuda Blue P (001 BB)		■	■	■
Crystal Golden Shadow (001 GSHA)			■	■
Crystal Shimmer (001 SHIM)			■	■
Crystal Silver Night (001 SINI)			■	■
Crystal Vitrail Light P (001 VL)		■	■	■
Crystal Vitrail Medium P (001 VM)		■	■	■

6438 Elliptic Cut Pendant

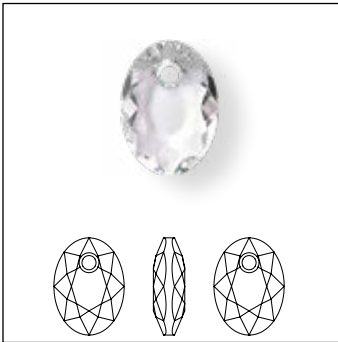

Size 9 mm

6438 Elliptic Cut Pendant

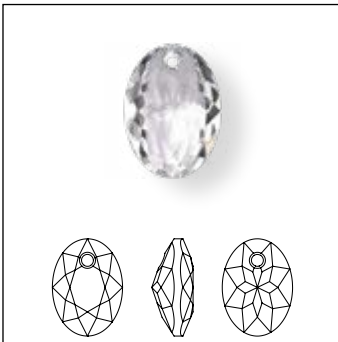

Size 11.5, 16 mm

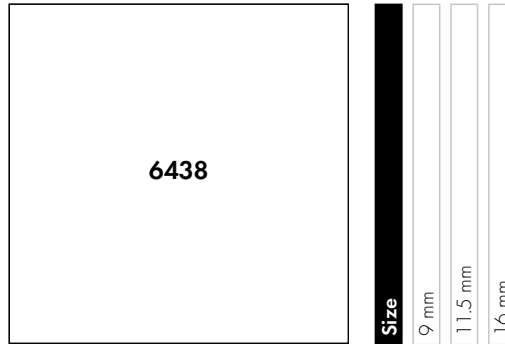

Size
9 mm
11.5 mm
16 mm

Crystal	9 mm	11.5 mm	16 mm
Crystal (001)	■	■	■
Colors			
Plain Colors			
Amethyst (204)	■	■	■
Aquamarine (202)	■	■	■
Blue Zircon (229)	■	■	■
Emerald (205)	■	■	■
Light Amethyst (212)	■	■	■
Light Rose (223)	■	■	■
Rose (209)	■	■	■
Sapphire (206)	■	■	■
Scarlet (276)	■	■	■
ReCreated™ Colors			
ReCreated™ Ice Blue (1405)	■	■	■
ReCreated™ Peridot (1408)	■	■	■
Crystal Effects			
Transparent Effects			
Crystal Aurore Boreale (001 AB)	■	■	■
Crystal Bermuda Blue P (001 BB)	■	■	■
Crystal Golden Shadow (001 GSHA)	■	■	■
Crystal Shimmer (001 SHIM)	■	■	■
Crystal Silver Night (001 SINI)	■	■	■
Crystal Vitrail Light P (001 VL)	■	■	■
Crystal Vitrail Medium P (001 VM)	■	■	■

6480 Spike Pendant

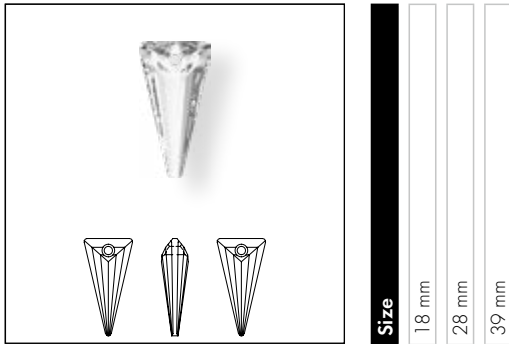

	18 mm	28 mm	39 mm
Crystal			
Crystal (001)	■	■	■
Colors			
Plain Colors			
Jet (280)	■	■	
Crystal Effects			
Transparent Effects			
Crystal Aurore Boreale (001 AB)	■	■	■
Crystal Bermuda Blue P (001 BB)	■	■	■
Crystal Blue Shade (001 BLSH)	■		
Crystal Golden Shadow (001 GSHA)	■	■	
Crystal Silver Night (001 SINI)	■	■	■
Crystal Vitrail Medium P (001 VM)	■	■	■

6565 Metallic Cap Pear-shaped Pendant

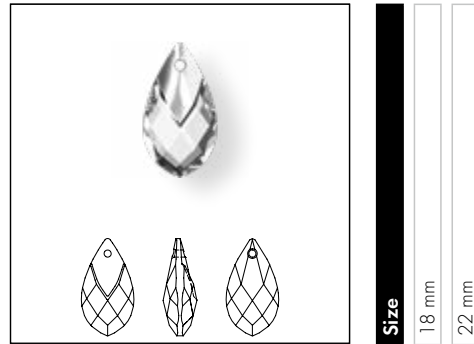

	18 mm	22 mm
Crystal Effects		
Metallic Effects		
Crystal & Light Chrome Z MCI (001 ITCHZ)	■	■
Color Effects		
Metallic Effects		
Aquamarine & Light Chrome Z MCI (202 ITCHZ)	■	■

6656 Galactic Vertical Pendant

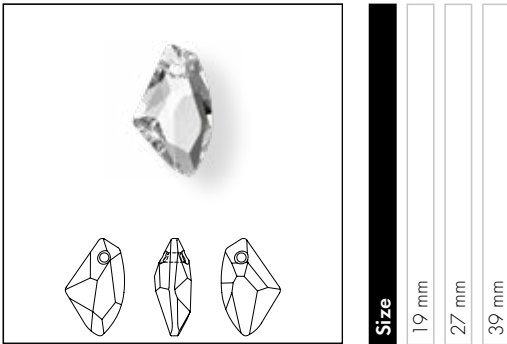

Size
19 mm
27 mm
39 mm

Crystal			
Crystal (001)	■	■	■
Colors			
Plain Colors			
Aquamarine (202)	■	■	
Light Rose (223)	■	■	
Tanzanite (539)	■	■	
ReCreated™ Colors			
ReCreated™ Peridot (1408)	■	■	
Crystal Effects			
Transparent Effects			
Crystal Bermuda Blue P (001 BB)	■	■	■
Crystal Golden Shadow (001 GSHA)	■	■	■
Crystal Moonlight (001 MOL)	■	■	■
Crystal Silver Shade (001 SSHA)	■	■	■

6670 De-Art Pendant

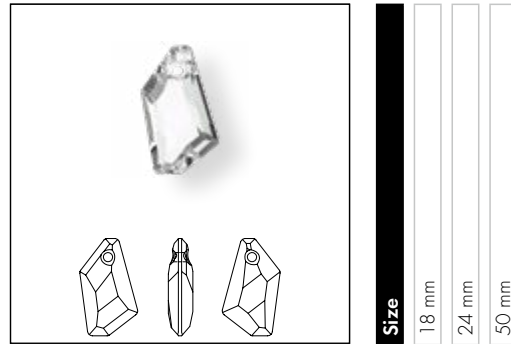

Size
18 mm
24 mm
50 mm

Crystal			
Crystal (001)	■	■	■
Colors			
Plain Colors			
Aquamarine (202)	■	■	
Crystal Effects			
Transparent Effects			
Crystal Aurore Boreale (001 AB)	■	■	■
Crystal Bermuda Blue P (001 BB)	■	■	■
Crystal Golden Shadow (001 GSHA)	■	■	■
Crystal Silver Night (001 SINI)	■	■	■

6673 Meteor Pendant

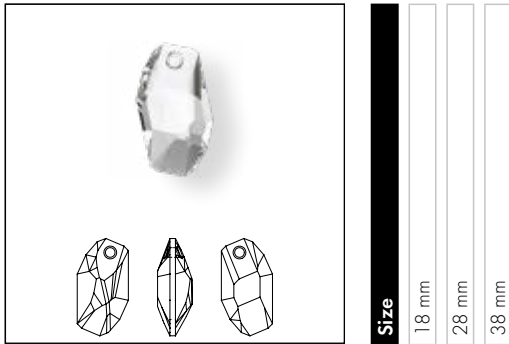

Size
18 mm
28 mm
38 mm

Crystal	Crystal (001)		
Colors			
Plain Colors			
Crystal Effects			
Transparent Effects			
	Crystal Aurore Boreale (001 AB)		
	Crystal Golden Shadow (001 GSHA)		

6680 Cosmic Pendant

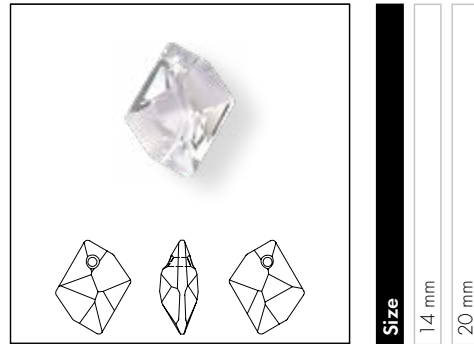

Size
14 mm
20 mm

Crystal	Crystal (001)		
Crystal Effects			
Transparent Effects			
	Crystal Aurore Boreale (001 AB)		
	Crystal Golden Shadow (001 GSHA)		

6685 Graphic Pendant

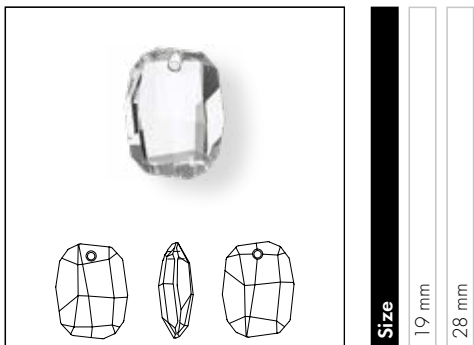

Size
19 mm
28 mm

Crystal	Crystal (001)		
Colors			
Plain Colors			
	Emerald (205)		
Crystal Effects			
Transparent Effects			
	Crystal Aurore Boreale (001 AB)		
	Crystal Golden Shadow (001 GSHA)		

6690 Wing Pendant

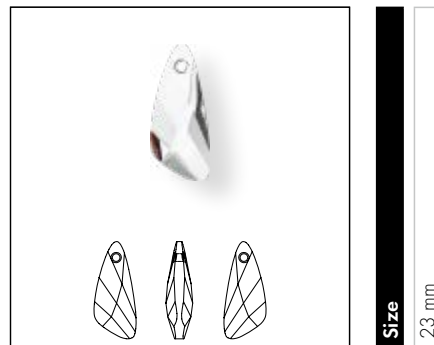

Size
23 mm

Crystal	Crystal (001)		
Colors			
Plain Colors			
	Capri Blue (243)		
Crystal Effects			
Transparent Effects			
	Crystal Aurore Boreale (001 AB)		
	Crystal Silver Night (001 SINI)		

6696 Urban Pendant

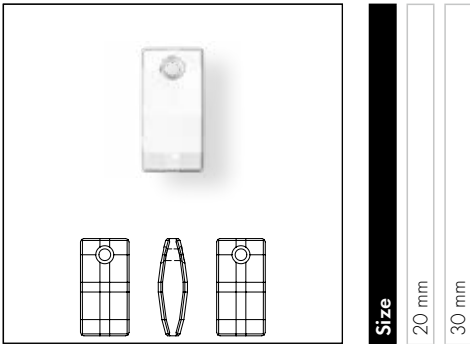

Size
20 mm
30 mm

- Crystal**
- Crystal (001)
- Crystal Effects**
- Transparent Effects**
- Crystal Aurore Boreale (001 AB)
- Crystal Bermuda Blue P (001 BB)
- Crystal Silver Night (001 SINI)

6704 Snowflake Pendant

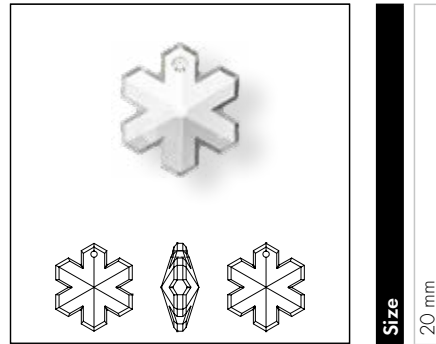

Size
20 mm

- Crystal**
- Crystal (001)
- Crystal Effects**
- Transparent Effects**
- Crystal Aurore Boreale (001 AB)

6714 Star Pendant

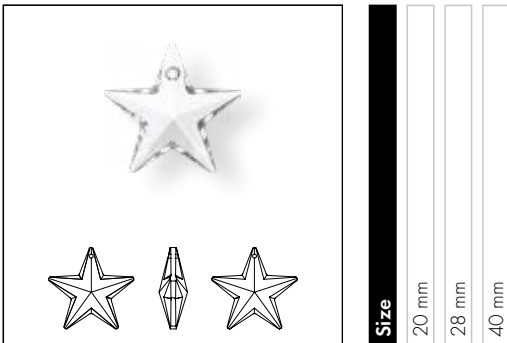

Size
20 mm
28 mm
40 mm

- Crystal**
- Crystal (001)
- Crystal Effects**
- Transparent Effects**
- Crystal Aurore Boreale (001 AB)

6721 Starfish Pendant

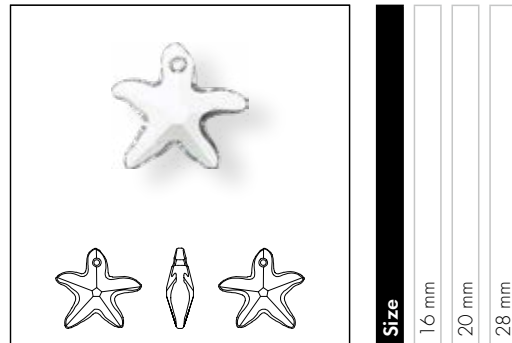

Size
16 mm
20 mm
28 mm

- Crystal**
- Crystal (001)
- Crystal Effects**
- Transparent Effects**
- Crystal Aurore Boreale (001 AB)
- Crystal Bermuda Blue P (001 BB)

Ocean Mysteries designed by Céline Cousteau

Design Story: A love for the sea runs through her veins: Céline Cousteau is a celebrated filmmaker, humanitarian, and environmentalist, as well as the granddaughter of legendary ocean explorer Jacques-Yves Cousteau. She presents her first ever designs made of crystals for Swarovski, inspired by one of her favorite places, the depths of the ocean. Taking inspiration from nature itself

and leaving its beauty unaltered, her stunningly life-like creatures are not only captivating and spellbinding, they also draw attention toward the mysterious, mostly unseen, and unexplored world beneath the ocean's surface on which all ocean life depends. These mysteries need to be protected for future generations, both above and below the water.

6731 Sea Snail Pendant partly frosted



Size 14 mm

6731 Sea Snail Pendant partly frosted



Size 28 mm

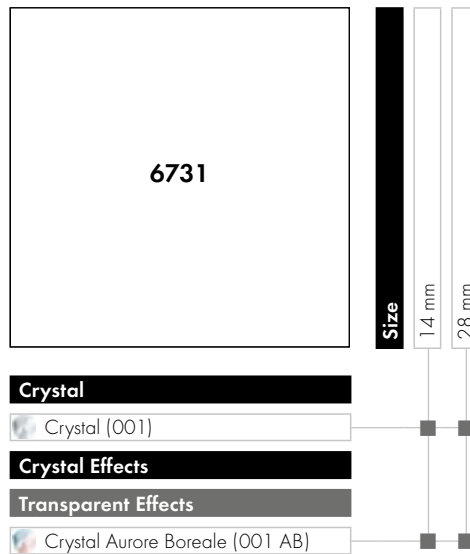

6735 Leaf Pendant

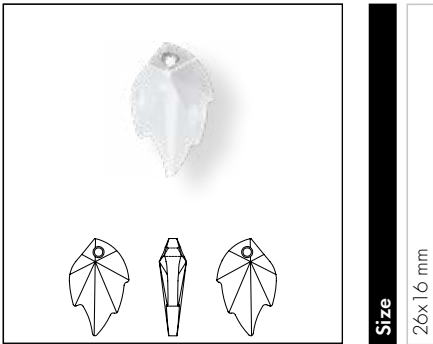

Size

26x16 mm

Crystal

Crystal (001)

Colors

Plain Colors

Emerald (205)

Crystal Effects

Transparent Effects

Crystal Aurore Boreale (001 AB)

Crystal Golden Shadow (001 GSHA)

6748 Edelweiss Pendant

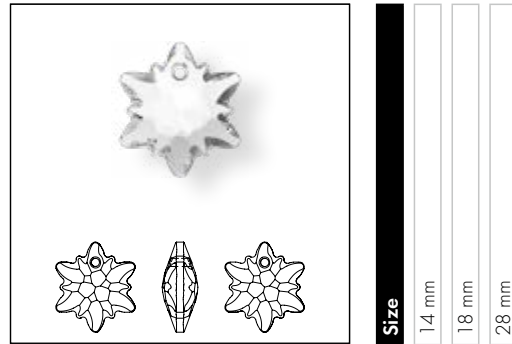

Size

14 mm

18 mm

28 mm

Crystal

Crystal (001)

Crystal Effects

Transparent Effects

Crystal Aurore Boreale (001 AB)

6866 Square Cross Pendant

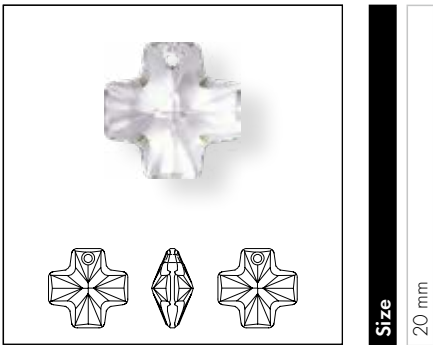

Size

20 mm

Crystal

Crystal (001)

Crystal Effects

Transparent Effects

Crystal Aurore Boreale (001 AB)

Product Details

Article Size	Packing Unit = Minimum Order Quantity in Pieces	Average Net Weight in Gram per Packing Unit Crystal (001)	Average Gross Weight in Gram per Packing Unit Crystal (001)
6000			
11x5.5 mm	288	99.8	123.1
13x6.5 mm	288	156.9	197.5
15x7.5 mm	144	129.8	153.4
22x11 mm	48	129.4	151.3
6002			
10x7 mm	144	91.4	109.3
15x11.5 mm	72	175.4	197.3
6007			
7x4 mm	360	46.7	55.8
9x5 mm	288	77.1	104.2
6010			
11x5.5 mm	144	57.4	75.9
13x6.5 mm	144	91.1	109.0
17x8.5 mm	36	57.3	77.2
21x10.5 mm	24	66.3	83.4
6015			
17 mm	72	93.2	111.5
21 mm	48	105.9	129.3
6017/G			
30 mm	12	25.0	45.6
56 mm	6	67.5	91.4
6020			
18 mm	36	49.7	72.1
30 mm	12	74.3	95.5
37 mm	6	76.4	82.5
6022			
14 mm	72	77.2	97.0
24 mm	24	133.9	155.5
6040			
20 mm	72	66.3	92.8
30 mm	30	85.4	116.4
40 mm	6	41.7	61.4
6049			
20 mm	72	170.5	200.4
30 mm	24	166.7	209.2
6090			
16x11 mm	72	55.8	75.8
22x15 mm	48	102.2	136.7
6100			
24x12 mm	36	54.5	83.9
6106			
16 mm	144	129.9	158.3
22 mm	96	208.1	248.5
28 mm	36	171.8	201.1
38 mm	9	91.1	121.6

Article Size	Packing Unit = Minimum Order Quantity in Pieces	Average Net Weight in Gram per Packing Unit Crystal (001)	Average Gross Weight in Gram per Packing Unit Crystal (001)
6210			
12 mm	144	67.8	90.9
17 mm	72	98.8	122.0
6215			
18 mm	72	183.2	210.5
6225			
10 mm	144	48.3	68.4
18 mm	24	41.6	59.0
28 mm	24	160.7	206.2
6228			
10.3x10 mm	288	124.6	152.6
14.4x14 mm	144	181.4	210.5
18x17.5 mm	72	188.0	211.7
28 mm	16	124.0	158.7
40 mm	6	155.2	182.9
6240			
12 mm	108	63.3	83.5
17 mm	72	116.4	137.0
27 mm	24	142.6	147.8
6261			
17 mm	48	48.2	76.6
27 mm	20	77.0	102.6
6264			
18 mm	48	93.4	109.1
28 mm	16	93.7	118.2
6328			
6 mm	360	78.5	89.5
8 mm	288	153.2	173.2
6428			
6 mm	720	80.1	89.5
8 mm	144	37.4	46.7
12 mm	144	121.8	141.6
6430			
8 mm	72	23.7	42.1
10 mm	48	31.7	51.9
14 mm	24	40.9	61.6
6431			
9 mm	72	22.1	40.5
11.5 mm	48	30.1	51.1
16 mm	24	41.9	62.6
6432			
8 mm	72	21.9	40.3
10.5 mm	48	31.6	51.8
14.5 mm	24	40.0	60.7

Article Size	Packing Unit = Minimum Order Quantity in Pieces	Average Net Weight in Gram per Packing Unit Crystal (001)	Average Gross Weight in Gram per Packing Unit Crystal (001)
6433			
9 mm	72	18.1	33.2
11.5 mm	48	28.8	46.1
16 mm	36	54.0	71.9
6434			
8 mm	72	20.1	40.3
10.5 mm	48	30.5	51.1
14.5 mm	24	38.5	59.2
6435			
9 mm	72	24.2	42.8
11.5 mm	48	35.1	53.7
16 mm	24	46.1	64.7
6436			
9 mm	72	26.9	45.3
11.5 mm	48	30.9	51.1
16 mm	24	47.4	65.8
6438			
9 mm	72	18.7	38.9
11.5 mm	48	28.3	48.5
16 mm	36	53.3	73.5
6480			
18 mm	48	42.7	64.1
28 mm	36	101.6	130.5
39 mm	16	105.6	133.7
6565			
18 mm	36	43.6	64.2
22 mm	24	54.9	75.0
6656			
19 mm	48	72.3	94.2
27 mm	30	126.1	159.6
39 mm	6	61.8	82.0
6670			
18 mm	72	68.4	104.6
24 mm	48	105.5	161.9
50 mm	6	104.7	126.8
6673			
18 mm	48	59.7	80.7
28 mm	20	89.0	112.2
38 mm	6	69.5	87.1
6680			
14 mm	144	118.7	145.1
20 mm	72	167.5	191.1
6685			
19 mm	48	104.5	127.4
28 mm	24	168.7	175.4

Article Size	Packing Unit = Minimum Order Quantity in Pieces	Average Net Weight in Gram per Packing Unit Crystal (001)	Average Gross Weight in Gram per Packing Unit Crystal (001)
6690			
23 mm	36	54.5	88.6
6696			
20 mm	24	53.5	70.6
30 mm	10	59.6	83.3
6704			
20 mm	48	131.4	155.0
6714			
20 mm	48	48.2	73.1
28 mm	24	112.5	156.1
40 mm	6	56.1	87.4
6721			
16 mm	72	105.1	131.7
20 mm	30	76.8	113.6
28 mm	12	66.3	93.7
6731			
14 mm	36	35.1	64.0
28 mm	8	76.4	98.2
6735			
26x16 mm	30	73.3	110.0
6748			
14 mm	72	65.3	90.0
18 mm	48	88.3	110.2
28 mm	18	115.7	145.4
6866			
20 mm	72	249.5	272.8



Crystal Transfers

































Crystal Transfers are enchanting motifs made from Swarovski Flat Backs Hotfix, utilizing XIRIUS and XILION Roses, Creation Stones, as well as Cabochons or Metallics in varying designs.

Able to incorporate up to 18 different elements or colors in a single motif, Crystal Transfers make sparkling creativity absolutely effortless. Easy to apply to a wide range of textiles they are ideal for Hotfix application on apparel and accessories. Furthermore, the self-adhesive Crystal IT Transfers can be applied to hard, non-washable surfaces, offering versatile design possibilities beyond fabric.

Our range of Inspirational Motifs has been engineered to offer a glimpse into the vast array of Transfer possibilities and may be ordered as they appear, or customized to your desire. As an additional service, our Design Experts are on hand to help bring your unique vision to life. Offering a carefully curated balance of large and small motifs across all price ranges, while showcasing a comprehensive selection of the elements available for use in Crystal Transfer designs, our Crystal Transfers are that versatile of all products, where the only limit is your imagination.

Overview of Flat Backs Hotfix for Crystal Transfers

Detailed information per Flat Back Hotfix may be found in chapter "Flat Backs Hotfix" pages 94 to 129.

1 2 3		1098 A HF PP 24 (SS 12), PP 31 (SS 16) SS 20, 24, 29, 34, 39	1 2		2300 M HF 8x4.8 mm	1 2		2715 M HF 3, 4, 6 mm
		2000 A HF SS 3			2303 M HF 8x5, 14x9 mm			2738 M HF 10x5, 12x6 mm
		2038 A HF SS 5, 6, 8, 10			2304 M HF 10x2.8, 14x3.9 mm			2739 M HF 5.8x5.3, 7x6.5 mm
		2038/1 A HF SS 10			2400 M HF 2.2, 3, 4, 6 mm			2740 M HF 8.3x8.3, 10x10 mm
		2078 A HF SS 12, 16, 20, 30, 34, 40, 48			2471 M HF 5, 7, 10 mm			2754 M HF 4, 6 mm
		2078/1 A HF SS 16, 20			2472 M HF 5, 7, 10 mm			2770 M HF 6x3.5 mm
		2080/4 HF SS 6, 10, 16, 20, 34			2510 M HF 3.7x1.9, 5x2.5 mm			2771 M HF 6.4x4.2, 8.6x5.6, 12.9x8.3 mm
		2100 SS 12, 16, 20, 30, 34, 40, 48			2555 M HF 8x2.6, 12x4 mm			2772 M HF 6.5x2.1, 8.6x2.8, 12.9x4.2 mm
		2200 M HF 4x2, 8x4 mm			2602 M HF 3.7x2.5, 8x5.5, 14x10 mm			2773 M HF 5x3, 6.6x3.9, 9.9x5.9 mm
		2201 M HF 4x1.8, 8x3.5, 14x6 mm			2603 M HF 4x3, 8x6, 14x10 mm			2774 M HF 6.3x4.2, 8.3x5.6, 12.5x8.4 mm
		2205 M HF 7.5, 10, 14 mm			2711 M HF 3.3, 6 mm			2775 M HF 5x4.2, 6.7x5.6, 10x8.4 mm

1 Top view 2 Side view 3 Back view

1 2



2776 M HF
8.2x4.2, 11x5.6,
16.5x8.4 mm



2777 M HF
5x4.2, 6.7x5.6,
10x8.4 mm



2788 M HF
8 mm



2808 M HF
3.6, 6, 10 mm



2813 M HF
8x5.5 mm

Metallics

To add a metallic look to your Transfer, you may choose from our Metallics assortment and simply include them into your Desing.



3490
3490/006
(M2)



3490
3490/400
(M4)



3490
3490/007
(M10)



3490
3490/012
(M2.5)



3490
3490/600
(M6)



3490
3490/300
(M3)



3490
3490/008
(M8)

Metallics & Inspirational Motifs



Gold¹ brushed
(081)



Silver brushed
(082)



Gun metal
brushed
(086)



Gold¹ polished
(091)



Silver polished
(092)



Gun metal
polished
(096)



Bronze brushed
(084)



Copper brushed
(080)



Black polished
(070)



Bronze polished
(094)



Copper polished
(090)



Signal White
(R 9003²)



Jet Black
(R 9005²)

¹ Golden colored

² Color tones according to RAL colors.

Crystal Transfers and Inspirational Motifs

ARTICLE EXPLANATION

944 269



C	280/001LTCH/001SINI/001/ 280HEM/215/215/001/253/ 280/253
E	CS5x2.5/CS3x3/CS4x4/ 2555MM12x4/2400MM6/ 2772MM6.5x2.1/2772MM8.6x2.8/ 2777MM10x8.4/2472MM5/ 2472MM7/2472MM10
S	~95x122
M	4 PCS 35%

944 269	C	E	S	M	35%
Article number	Color assortment	Elements	Motif size in mm	Minimum order quantity in pieces (PCS)	% of actual size
	Color code 1 (280) corresponds to element 1 (CS5x2.5); color code 2 (001LTCH) corresponds to element 2 (CS3x3) etc.	For details of stone sizes and element codes, please refer to the product charts at the beginning of this chapter.			
	For details please refer to the product charts at the beginning of this chapter and the chapter Flat Backs Hotfix pages 84–113.				

ORDERING EXAMPLE & PRODUCT VARIETY EXPLANATION

944 269	C280	001LTCH
Article number	Color of crystals corresponding to element 1; color of the most frequently used element in the motif	Color of crystals corresponding to element 2; color of the second most frequently used element in the motif

INSPIRATIONAL MOTIFS

13 468

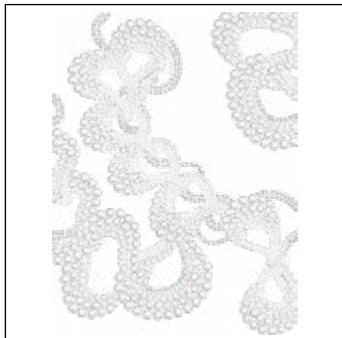

C 001650/001650/001650/
001650/001/001MOL

E P3/P4/P2/P5/S3/S6

S ~130x170

M 3 PCS **25%**

13 477

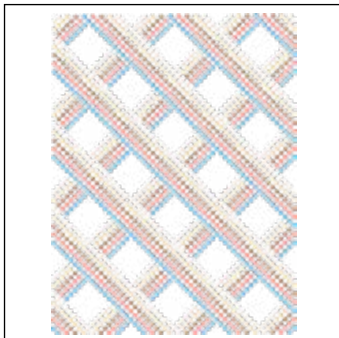

C R1019/R9003-001L164I/
001L162I/001L163I

E M2.5/M2.5-S10/S10/S10

S ~129x170

M 3 PCS **25%**

13 486

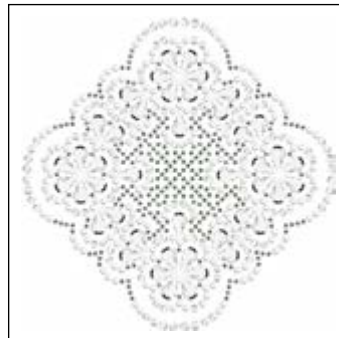

C 001650/001/215/001/001

E P2/CS8x5/S3/S8/S10

S ~92x92

M 10 PCS **45%**

13 493

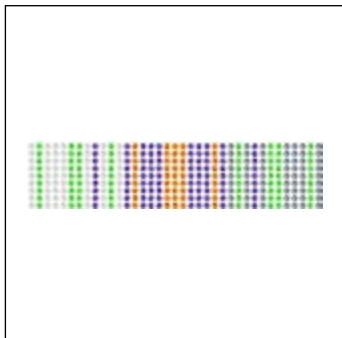

C 539/214/001L1111I/001L139I/
203

E S10/S10/S10/S10/S10

S ~129x29

M 15 PCS **30%**

949 861

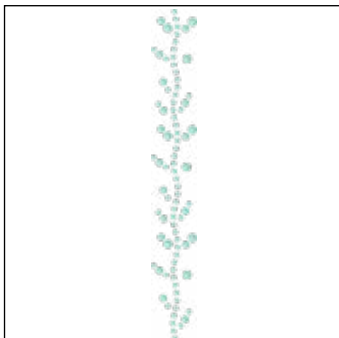

C 001L168I/001L168I/001L168I

E S10/S16/S20

S ~23x175

M 30 PCS **25%**

952 241

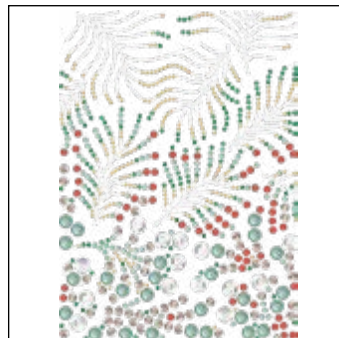

C 001/1407/360/001L165I/
001L160I/284/001L165I/001

E S3/S6/S8/S10/S16/S20/
S34/S40

S ~126x173

M 3 PCS **25%**

954 692

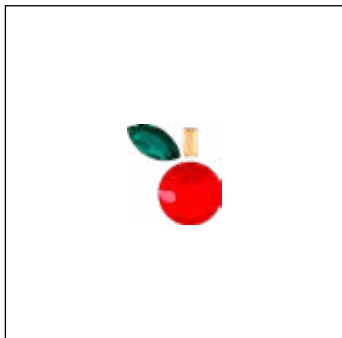

C 205/227/246

E CS8X4/S40/2510MM3.7X1.9

S ~12x13

M 60 PCS **100%**

954 694

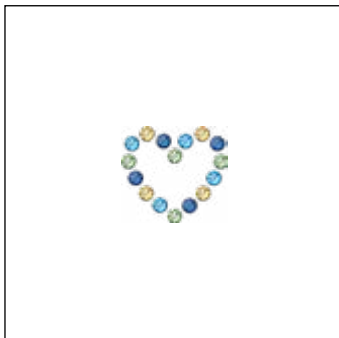

C 1408/1405/1404/1407

E S6/S6/S6/S6

S ~14x13

M 200 PCS **100%**

954 695

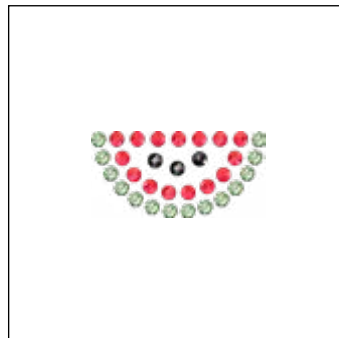

C 542/1408/280HEM

E S6/S6/S6

S ~23x11

M 150 PCS **100%**

Inspirational Motifs

954 700

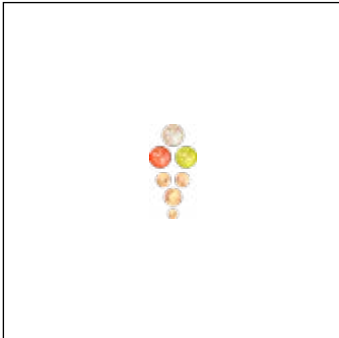

C 001L164I/001L136I/001L138I/
001GSHA/001GSHA/001GSHA

E P3/P3/P3/S3/S6/S8

S ~6x13

M 242 PCS **100%**

954 720



C 001650/001L164I/001650/
234/001L164I/001L164I

E P3/P4/P2/S20/S34/2100SS12

S ~130x115

M 3 PCS **30%**

954 697



C 001GSHA/001GSHA/001GSHA

E CS5X2.5/2715MM30/2472MM7

S ~17x8

M 176 PCS **100%**

957 249



C 001AUR/001AUR

E S3/S6

S ~70x59

M 20 PCS **60%**

957 426



C 001AUR/001AUR/001SHIM/
001AUR/001AUR/001SHIM/
001AUR/001AUR/001SHIM

E CS3X3/S6/S6/S8/S10/S10/
2200MM4X2/2510MM3.7X1.9/
2510MM3.7X1.9

S ~116x172

M 3 PCS **25%**

957 444



C 001650/001650/001

E P3/P2/S3

S ~130x172

M 3 PCS **25%**

957 501



C 213/001AUR/1407

E S8/S8/S8

S ~113x171

M 8 PCS **25%**

957 557

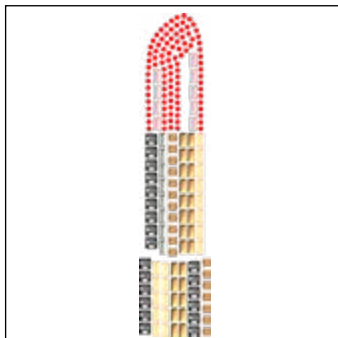

C 280HEM/227/227/001GSHA/
001AUR/001GSHA/001AB/215

E CS3X3/S3/S3/2400MM2.2/
2510MM3.7X1.9/
2510MM3.7X1.9/2510MM3.7X1.9/
2510MM3.7X1.9

S ~19x85

M 35 PCS **50%**

957 558

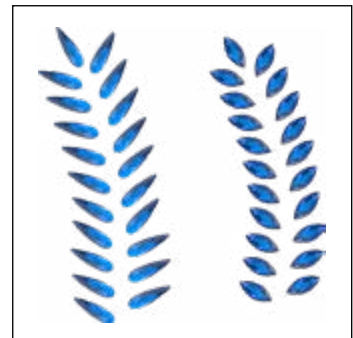

C 001HEL/001HEL

E 2304MM10X2.8/2201MM8X3.5

S ~63x65

M 15 PCS **60%**

SPECIAL MOTIF SERVICE

A special motif is any individual design created by the customer that differs to the Crystal Transfers Inspirational Collection. This service opens up an abundance of customization possibilities. You also no longer need to set your motif by hand. You can rely on Swarovski's long-standing experience and design expertise and can order a convenient, ready-to-apply design. A range of customization options for existing motifs is

Customization Possibilities

- Change of elements in an existing motif
- Change of size of an existing motif
- Logos or brand names
- Your desired design
- Up to 18 elements or colors possible per Transfer motif

Ordering Process

Send your request with the drawing you wish to order to your nearest Swarovski sales office. Make sure you include all measurements for the desired motif. Please also indicate which product group your special motif applies to (Crystal Transfers, Crystal-it, Crystal Mesh, etc.). You will then receive a quotation including your article number,

Please Note

Please always submit the drawing of your desired motif to represent it in the actual size you require. A small sketch, when enlarged to the desired size, will have blurred lines that will make it difficult to correctly reproduce. Pictures or drawings representing 100% size of the design or very good quality scans in JPG, BMP, or DXF format will ensure that we have clear data to work with. These can also be sent via email. When the sketch is submitted as a copy by email, please include a scale legend (e.g. copy/scan

available (see "Customization Possibilities" below). You can also submit design sketches that meet your special requirements – such as a brand image or an image for a particular sales campaign or garment. This will then be made up according to your specifications using Computer Aided Design, which means that adjustments can be made easily according to your needs.

minimum order quantity, price, and the line drawing of your special motif in PDF format. Please contact your Swarovski sales office again if any changes are required. Your special motif will be produced and delivered following your confirmation.

with a ruler next to the drawing). This will ensure that the desired size of the motif can be identified.

Special productions are generally offered to all our customers if these are deemed to be feasible and comply with our General Terms and Conditions. Please note that ordering a design does not grant exclusive production of this design to the customer.

Crystal-it Infinity

Crystal-it Infinity is made up of Flat Backs in different shapes, sizes, and colors. You may use up to 9 different elements per motif.

It is an easy-to-apply product thanks to the specially developed self-adhesive glue on the back of the stones. You can create your own individual and exclusive Crystal-it Infinity designs with Swarovski's special motif service.

ARTICLE EXPLANATION

75 516

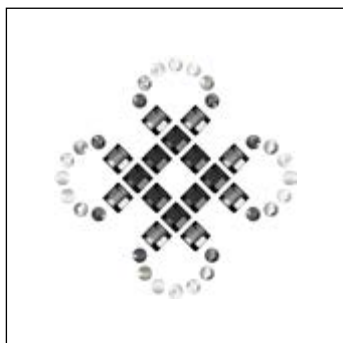

C	001/001SSHA/001SINI/280/280HEM
E	S6/S6/S6/CS3x3/CS3x3
S	~32x32 (TAPE : 75x53)
M	200 PCS 100%

09

75 516	C	E	S	M	100%
Article number	Color assortment	Elements	Motif size in mm	Minimum order quantity in pieces (PCS)	% of actual size
	For further details, please refer to the color and product charts at the beginning of this chapter. Color code 1 (001) corresponds to element 1 (S6); color code 2 (001SSHA) corresponds to element 2 (S6) etc.	For details of stone sizes and element codes, please refer to the color and product charts at the beginning of this chapter.	Size of the tape the motif is attached to in mm (TAPE)		

Please note: Due to their physical properties, Swarovski's self adhesive products are unsuitable for other uses such as gluing onto teeth, using on or near mucous membranes, and other unsafe uses.

ORDERING EXAMPLE & PRODUCT VARIETY EXPLANATION

75 516	022	001	001SSHA	001SINI	280
Article number	Carrier film color 022 White	Crystal color corresponding to element 1, color of most frequently used element in the motif. Please see the respective color chart for all available reference codes.	Crystal color corresponding to element 2, color of second most frequently used element in the motif.	Crystal color corresponding to element 3, color of third most frequently used element in the motif.	Crystal color corresponding to element 4, color of fourth most frequently used element in the motif.

FLAT BACKS FOR CRYSTAL-IT INFINITY

2038 XILION Rose

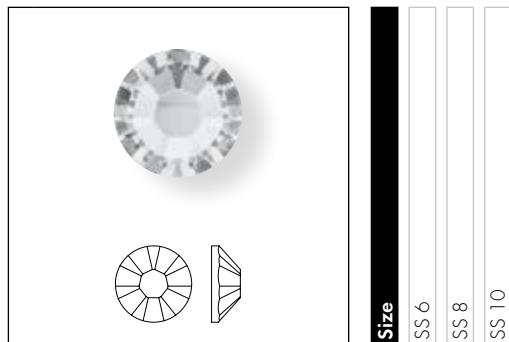

Size	SS 6	SS 8	SS 10
------	------	------	-------

Crystal			
Crystal (001)	■	■	■
Colors			
Plain Colors			
Amethyst (204)	■	■	■
Aquamarine (202)	■	■	■
Fuchsia (502)	■	■	■
Greige (284)	■	■	■
Indian Siam (327)	■	■	■
Jet (280)	■	■	■
Light Peach (362)	■	■	■
Light Rose (223)	■	■	■
Montana (207)	■	■	■
Peridot (214)	■	■	■
Sapphire (206)	■	■	■
Siam (208)	■	■	■
Tanzanite (539)	■	■	■
Topaz (203)	■	■	■
Crystal Effects			
Transparent Effects			
Crystal Aurore Boreale (001 AB)	■	■	■
Crystal Golden Shadow (001 GSHA)	■	■	■
Crystal Silver Night (001 SINI)	■	■	■
Crystal Silver Shade (001 SSHA)	■	■	■
Metallic Effects			
Crystal Light Chrome (001 LTCH)	■	■	■
Color Effects			
Metallic Effects			
Jet Hematite (280 HEM)	■	■	■

2078 XIRIUS Rose



Size	SS 12	SS 16
------	-------	-------

Crystal		
Crystal (001)	■	■
Colors		
Plain Colors		
Amethyst (204)	■	■
Aquamarine (202)	■	■
Fuchsia (502)	■	■
Greige (284)	■	■
Indian Siam (327)	■	■
Jet (280)	■	■
Light Peach (362)	■	■
Light Rose (223)	■	■
Montana (207)	■	■
Peridot (214)	■	■
Sapphire (206)	■	■
Siam (208)	■	■
Tanzanite (539)	■	■
Topaz (203)	■	■
Crystal Effects		
Transparent Effects		
Crystal Aurore Boreale (001 AB)	■	■
Crystal Golden Shadow (001 GSHA)	■	■
Crystal Silver Night (001 SINI)	■	■
Crystal Silver Shade (001 SSHA)	■	■
Metallic Effects		
Crystal Light Chrome (001 LTCH)	■	■
Color Effects		
Metallic Effects		
Jet Hematite (280 HEM)	■	■

2300 Drop Flat Back

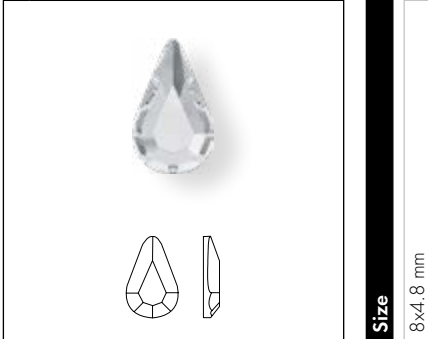

Size
8x4.8 mm

- Crystal**
- Crystal (001)
- Colors**
- Plain Colors**
- Jet (280)
- Crystal Effects**
- Transparent Effects**
- Crystal Aurore Boreale (001 AB)
- Crystal Golden Shadow (001 GSHA)

2400 Square Flat Back

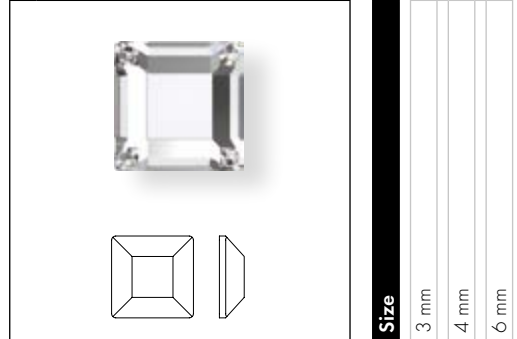

Size
3 mm
4 mm
6 mm

- Crystal**
- Crystal (001)
- Colors**
- Plain Colors**
- Jet (280)
- Crystal Effects**
- Transparent Effects**
- Crystal Aurore Boreale (001 AB)
- Crystal Golden Shadow (001 GSHA)
- Color Effects**
- Metallic Effects**
- Jet Hematite (280 HEM)

Crystal-it Infinity

2510 Baguette Flat Back

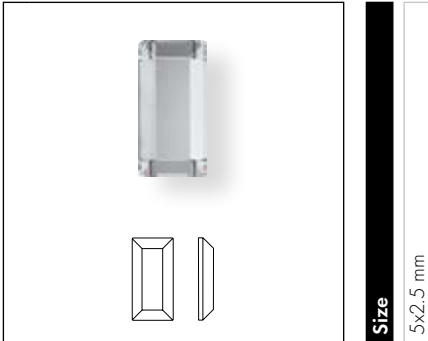

Crystal

Crystal (001)

Colors

Plain Colors

Jet (280)

Crystal Effects

Transparent Effects

Crystal Aurore Boreale (001 AB)

INSPIRATIONAL MOTIFS

75 517



C 207/206/202/001
E S10/S10/S10/S10
S ~32x36 (TAPE : 75x53)
M 200 PCS **100%**

75 519

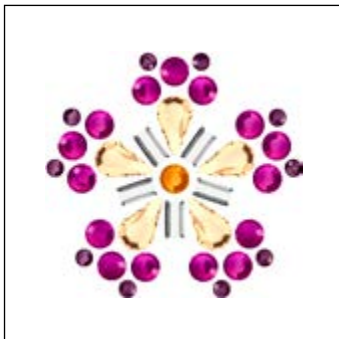

C 204/502/203/001GSHA/001
E S8/S16T/S16T/CS8x5/CS5x2.5
S ~34x32 (TAPE : 75x53)
M 200 PCS **100%**

75 520



C 001GSHA/001GSHA/001GSHA/
001GSHA
E S6/S8/S10/CS8x5
S ~56x42 (TAPE : 75x105)
M 100 PCS **75%**

75 522

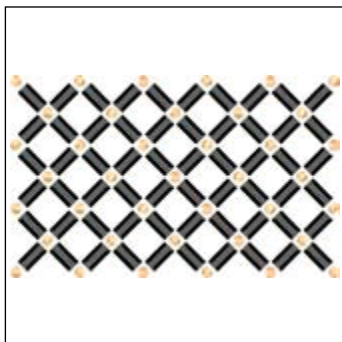

C 001GSHA/280
E S6/CS5x2.5
S ~58x35 (TAPE : 75x53)
M 200 PCS **75%**

75 523



C 203/207/502/001
E S6/S6/S6/S6
S ~41x41 (TAPE : 75x105)
M 100 PCS **100%**

Crystal-it Infinity

SPECIAL MOTIF SERVICE

A special motif is any individual design created by the customer that differs to the Self-adhesive Elements Standard or Crystal Inspirations Collections. This service opens up an abundance of customization possibilities and enables you to profit from Swarovski's long-standing experience and design expertise. A range of customization options for existing motifs is also available (see

"Customization Possibilities" below). You can also submit design sketches that meet your special requirements, such as a brand image or an image for a particular sales campaign. This will then be made up according to your specifications using Computer Aided Design, which means that adjustments can be made easily according to your needs.

Customization Possibilities for Crystal-It Infinity

- Change of elements and colors of elements of an existing motif
- Change of size of an existing motif
- Logos or brand names
- Up to 9 different elements per motif are possible

Ordering Process

Send your request with the drawing you wish to order to your nearest Swarovski sales office. Make sure you include all measurements for the desired motif. Please also indicate which product group your special motif applies to (Crystal-it, Crystal Fabric-it, Crystaltex-it, Crystaltex-it Chaton, Crystal Fine Rocks-it). You will then receive

a quotation including your article number, minimum order quantity, price, and the line drawing of your special motif in PDF format. Please contact your Swarovski sales office again if any changes are required. Your special motif will be produced and delivered following your confirmation.

Please Note

Please always submit the drawing of your desired motif to represent it in the actual size you require. A small sketch, when enlarged to the desired size, will have blurred lines that will make it difficult to correctly reproduce. Pictures or drawings representing 100% size of the design or very good quality scans in JPG, BMP, or DXF format will ensure that we have clear data to work with. These can also be sent via email. If you are sending a sewing pattern, please include the whole pattern and not just sections. When the sketch is submitted as a copy by email, please include a scale legend (e.g. copy/scan with a ruler next to the drawing). This will ensure that the desired size of the motif can be identified.

Special productions are generally offered to all our customers if these are deemed to be feasible and comply with our General Terms and Conditions. Please note that ordering a design does not grant exclusive production of this design to the customer.

If detailed information on potential tolerances is needed (e.g. cavity production for metal parts), please contact Swarovski who will enter an application request into our application database.



Crystal Textures

Crystal Textures offer a uniquely differentiated look to unlock unlimited design potential.

By merging the sparkle and brilliance of crystals into cohesive, harmonious designs, they provide customization flexibility and highly personalized solutions that are perfectly aligned with our clients' needs for design freedom, distinctive applications, and cutting-edge technological innovation.

These versatile products combine Swarovski's elegant crystals with specialized gluing systems, each tailored to specific carrier materials and application arenas. Swarovski Crystal Textures solutions are ideal for use in textiles, interior design, jewelry, packaging, and accessories, inspiring boundless artistic possibilities.

Crystal Texture Product Overview

CRYSTAL FABRIC FAMILY

Crystal Fabric Bandings

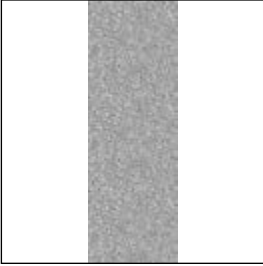

Crystal Fabric Motifs

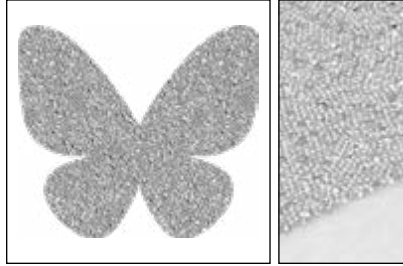

CRYSTAL INTARSIA

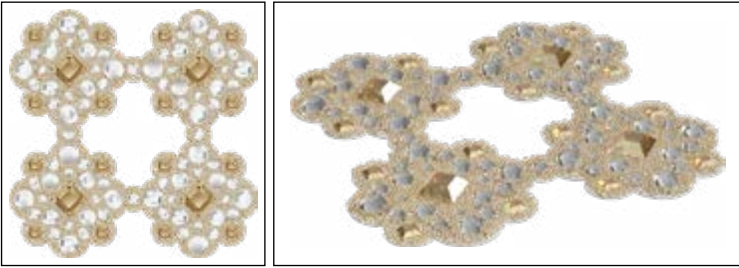

Crystal Texture Product Overview

CRYSTAL ROCKS FAMILY

Crystal Rocks



Fine Rocks

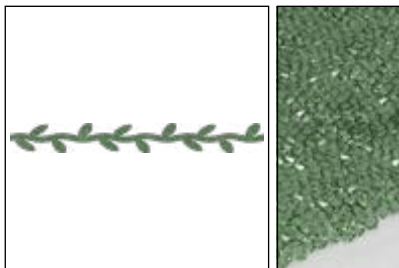

Ultrafine Rocks



CRYSTALTEX CHATON BANDINGS

Straight Line

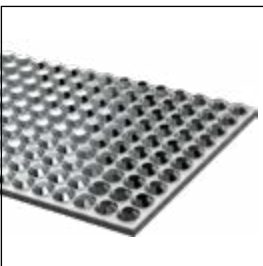

Honeycomb



Crystal Texture Special Features Overview

GRAPHIC PRINT

Foil Print (FP)



Glass Print (GP)



FP + GP



UNLIMITED TECHNOLOGY

Standard

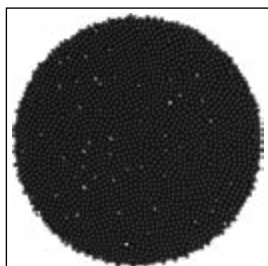

Unlimited (UL)

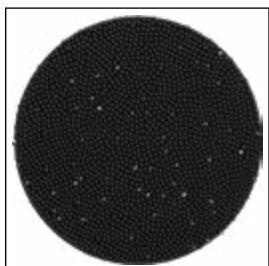

FOIL OVERLAY TECHNOLOGY

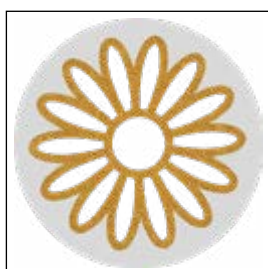

Crystal Textures

AVAILABLE CRYSTAL TEXTURES PRODUCTS AND FIELDS OF APPLICATION

Crystal textures products offer a **unique, differentiated and new look**, which allows **endless design possibilities**.

Bringing together the sparkle and colors of Swarovski crystals, into integrated harmonic designs they provide **maximum customization flexibility**, and highly personalized solutions that perfectly fit with our client needs in terms of **design freedom, application differentiation and technological advancement**.

Different adhesive systems, already applied on the reverse side of the product, allow infinite application possibilities, optimized for each carrier material and field of application.

They are ideal for use in apparel and accessories segment, as well as in interior and tech segments.

Due to its outstanding bonding performance, Crystal textures products in **Hotfix** are perfect for a variety of textile applications with high performance requirements. Crystal textures products in **Coldfix** are developed especially for materials that are not suitable for Hotfix applications, such as real and artificial leather and functional fabrics.

Crystal Textures IT on the other hand, are ready to apply and perfect for solid materials such as paper, metal and glass, allowing easy and fast application.

Finally, **Removable foil** products, allow to apply and remove quickly the product onto solid surfaces such as metal, glass, plastic and artificial leather, for an effortless personalization.

Crystal Textures

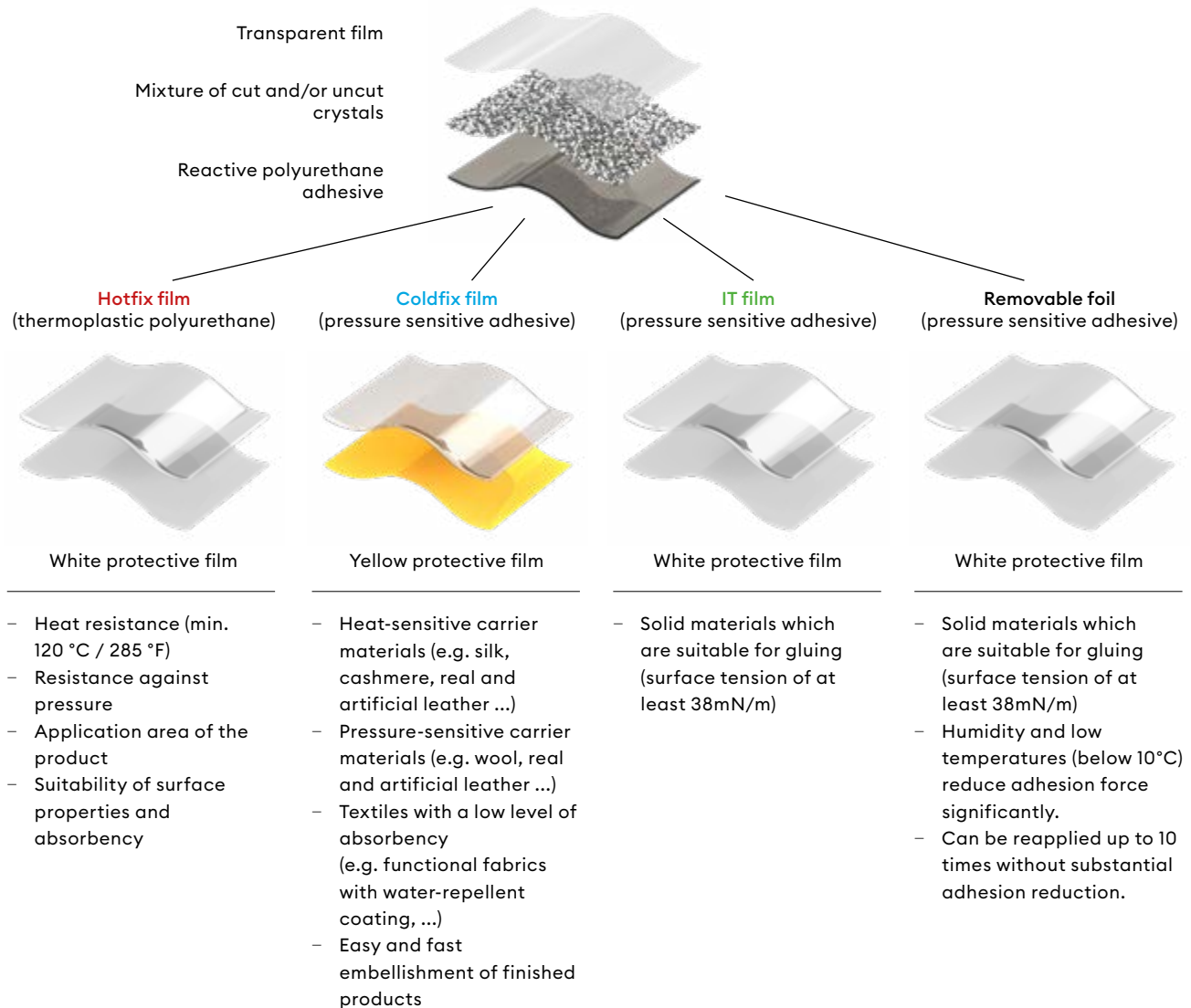

Please keep in mind: Coldfix is not a replacement for our Hotfix products – it is a new alternative for difficult carrier materials that are incompatible with Hotfix products.

If Hotfix is applicable, we recommend using Hotfix technique as the achievable bonding strength is higher than applying a Coldfix product.

Before beginning the application process, you should always check whether the carrier material is suitable for application of Self-adhesive Elements.

There are different material checks necessary, depending if you want to apply a Crystal textures product in **Hotfix** or a Crystal texture product in **IT** or **Removable Foil** on a **solid material** or a **Coldfix** product onto a **textile** or **leather carrier material**.

Nevertheless, please note that there are certain types of plastics used for **solid materials, textile and leather treatments** that are difficult for any gluing connection.

The following table contains a selection of materials that can cause problems for any glue application:

Plastic	Examples	Adhesive Qualities
Polyamide (PA)	Degamid, Nylon, Perlon	very difficult
Polyethylene (PE)	Geberit, Hostalen G, Ferrozell	difficult
Polyethylene Terephthalate (PET)	Cardura, Atlas, Eralyt	difficult
Polyoxymethylene (POM)	Delrin, Kematal, Ertacetal	difficult
Polypropylene (PP)	Moplefan, Proplex, Verelite	difficult
Polytetrafluoroethylene (PTFE)	Teflon®, Gaflon, Ferrotron	very difficult
SILICONE	Silopren, Contiduct, Corotex	very difficult

10

To increase the bonding strength of a **Coldfix** product or **Removable Foil** product onto leather surfaces, experience shows that in some cases it could be helpful to clean the carrier material with isopropyl alcohol before applying

the **Coldfix** product. We strongly recommend carrying out test to check if the carrier material does not get effected/damaged due to the alcohol.

To ensure the best possible result, test applications on the intended carrier material are strongly recommended. For information especially regarding material limitations please refer to our Application Manual.

Crystal Fabric Family

A ground-breaking innovation, Crystal Fabric features a carrier foil lavishly encrusted with thousands of tiny uncut crystal balls and delicate double-pointed Chatons. The thinnest and lightest crystallization option available, it delivers exceptional flexibility with mesmerizing shine – ideal for delicate fabrics and refined designs. Used for textiles, accessories, jewelry, eyewear, watches, packaging, and interior décor, Crystal Fabric infuses every creation with a luxurious, high-end touch at an accessible price point.

Setting a new standard in sparkle, its appearance transforms dramatically with the carrier's color and finish – ranging from a soft, mysterious gleam on black film to a radiant, luminous shimmer on transparent foil. Every motif can be fully customized – whether to express brand identity, create a captivating design for a special campaign, or embellishing a one-of-a-kind creation.

Crystal Fabric Bandings

- Application: Hotfix or IT (Self-Adhesive)
- Foil Colors: Transparent, Black
- Special Features Available: n.a.
- Segments: Accessories, Apparel, Footwear, Jewelry, Interior Design

ARTICLE EXPLANATION

57 000



C	1010-001 GSHA
W	001, 002, 003, 005, 010, 015
M	10 M ¹ 100%

Crystal Fabric Family

57 000	C	W	M	100%
Article number	Color of crystals	Width of banding	Minimum order quantity in meters (M)	% of actual size

ORDERING EXAMPLE & PRODUCT VARIETY EXPLANATION

57 000	002	I	010	001 GSHA
Article number	3-digit code for width	Type of base material	Color of base material	Color of crystals
	001 1 cm	Hotfix	010 Transparent	Please see the respective product matrix for all available reference codes.
	002 2 cm	I IT (Self-Adhesive)	012 Black	
	003 3 cm			
	005 5 cm			
	010 10 cm			
	015 15 cm			

¹ Please note: the 10-meter packing unit can be delivered in batches (max. three parts with a minimum length of 1 meter for each batch).

Crystal Fabric Motifs

- Application: Hotfix, Coldfix, IT (Self-Adhesive), and Removable Foil (only transparent)
- Foil Colors: Transparent, Black
- Special Features Available: Graphics, Foil Overlay, Unlimited
- Segments: Accessories, Apparel, Footwear, Jewelry, Interior Design, Packaging

ARTICLE EXPLANATION

631 370



C	C010001GSHA
S	~45x45
M	102 PCS 100%

10

631 370	C	S	M	100%
Article number	Color of crystals	Motif size in mm	Minimum order quantity in pieces (PCS)	% of actual size

ORDERING EXAMPLE & PRODUCT VARIETY EXPLANATION

631 370	C	010	001 GSHA
Article number	Type of base material	Color of base material	Color of crystals Please see the respective product matrix for all available reference codes.
	Hotfix	010 Transparent	
	C Coldfix	012 Black	
	I IT (Self-Adhesive)		
	R Removable foil		

AVAILABLE BASE MATERIALS AND CRYSTAL COLORS & EFFECTS

Crystal Fabric Family

<p>57 000 Bandings</p> <p>57 392 Customized Motif Number</p>		Crystal Fabric Bandings		Width in cm		Color of Film		Crystal Fabric Motifs		Color of Film		
			001	002	003	005	010	015	010 Transparent (HF; IT)	012 Black (HF; IT)	010 Transparent (HF; CF*; IT; RM*)	012 Black (HF; CF*; IT)
Crystal Effects												
Transparent Effects												
	Crystal Aurore Boreale (001 AB)	■	■	■	■	■	■	■	■	■	■	■
	Crystal Antique Pink (001 ANTP)	■	■	■	■	■	■	■	■	■	■	■
	Crystal Golden Shadow (001 GSHA)	■	■	■	■	■	■	■	■	■	■	■
	Crystal Heliotrope (001 HEL)	■	■	■	■	■	■	■	■	■	■	■
	Crystal Moonlight (001 MOL)	■	■	■	■	■	■	■	■	■	■	■
	Crystal Paradise Shine (001 PARSH)	■	■	■	■	■	■	■	■	■	■	■
Metallic Effects												
	Crystal Chrome (001 CHRM)	■	■	■	■	■	■	■	■	■	■	■
	Crystal Comet Argent Light (001 CAL)	■	■	■	■	■	■	■	■	■	■	■
	Crystal Metallic Light Gold (001 MLGLD)	■	■	■	■	■	■	■	■	■	■	■
	Crystal Metallic Sunshine (001 METSH)**	■	■	■	■	■	■	■	■	■	■	■
Color Effects												
Metallic Effects												
	Jet Hematite (280 HEM)	■	■	■	■	■	■	■	■	■	■	■
Multicolors												
	Crystal & Crystal Moonlight (001 M500)	■	■	■	■	■	■	■	■	■	■	■

* Coldfix and Removable foil only available for motifs

** Crystal Metallic Sunshine (001 METSH) is not suitable for swimwear because effect 001 METSH is highly sensitive to seawater, sweat, and chlorine.

OVERVIEW OF AVAILABLE COLORS & EFFECTS

Crystal Aurore Boreale (001 AB)

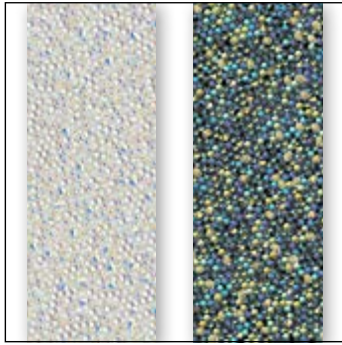

010 Transparent 012 Black

Crystal Antique Pink (001 ANTP)



010 Transparent

Crystal Golden Shadow (001 GSHA)



010 Transparent 012 Black

Crystal Heliotrope (001 HEL)



010 Transparent 012 Black

Crystal Moonlight (001 MOL)



010 Transparent 012 Black

Crystal Paradise Shine (001 PARSH)

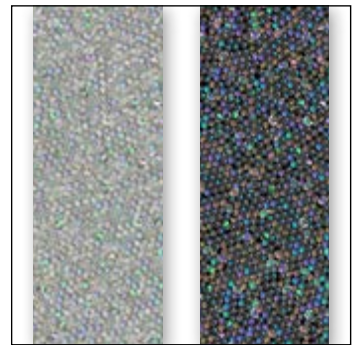

010 Transparent 012 Black

Crystal Chrome (001 CHRM)

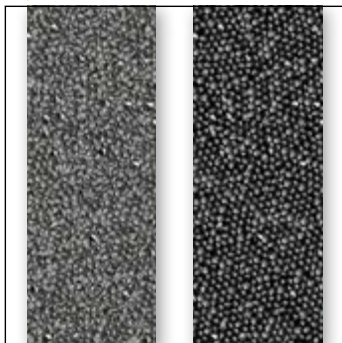

010 Transparent 012 Black

Crystal Comet Argent Light (001 CAL)

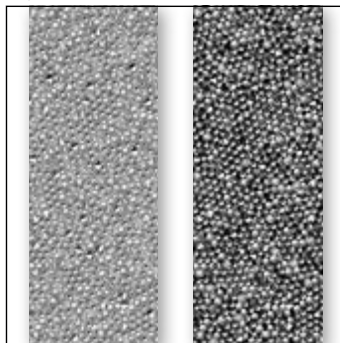

010 Transparent 012 Black

Crystal Metallic Light Gold (001 MGLD)



010 Transparent 012 Black

Crystal Metallic Sunshine (001 METSH)



010 Transparent

012 Black

Jet Hematite (280 HEM)



012 Black

Crystal & Crystal Moonlight (001 M500)



010 Transparent

012 Black

INSPIRATIONAL MOTIFS

57 392



C 012-001MOL
S ~30x30
M 300 PCS 100%

57 412

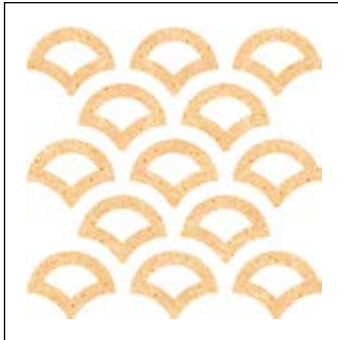

C 010-001METSH
S ~65x64
M 52 PCS 60%

57 440



C 012-001MLGD
S ~37x37
M 140 PCS 100%

57 441



C 010-001ANTP
S ~128x32
M 56 PCS 33%

57 442



C 012-001CAL
S ~124x56
M 35 PCS 33%

57 443

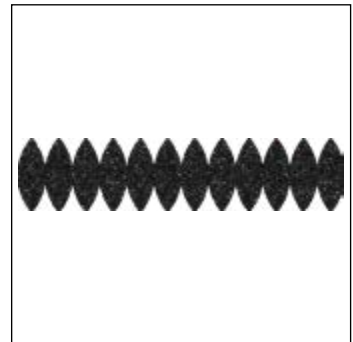

C 012-280HEM
S ~98x22
M 90 PCS 44%

57 444



C 012-001AB
S ~45x40
M 114 PCS 90%

57 445

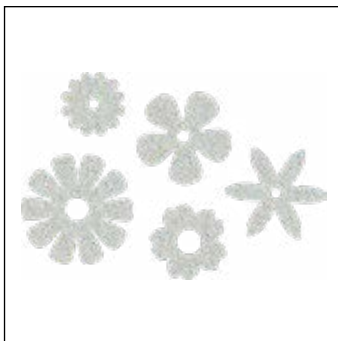

C 010-001AB
S ~90x61
M 50 PCS 45%

57 446



C 010-001GSHA
S ~57x67
M 64 PCS 60%

Please note: all motifs are available in certain color/film variations (see color matrix).

TECHNICAL PRODUCT INFORMATION

Crystal Fabric Family

	Crystal Fabric Motifs	Crystal Fabric Bandings
Min. motif size	(10x10 mm) or 1.0 cm ²	n.a.
Max. motif size	980x330 mm Standard 400x330 mm (Graphics, UL, FO)	n.a.
Min. product width	3 mm	n.a.
Min. width of holes within motif	3 mm	n.a.
Min. distance between 2 motifs	3 mm	n.a.
Rounding Radius (edges & angles less than =/< 90° need to be rounded off)	0.75 mm	n.a.
Max. amount of different colors/sizes of Crystals	1 Crystal Fabric Mixture Color + 1 Carrier Foil Color	1 Crystal Fabric Mixture Color + 1 Carrier Foil Color
Min. motif size for Foil Overlay Feature	(10x10 mm) or 1.0 cm ²	n.a.
Foil Overlay min./max. width outside	min. 3 mm / max. 50 mm	n.a.
Foil Overlay inside (between crystal-covered surfaces)	min. 3 mm / max. 50 mm	n.a.
Foil Overlay min. surface	0.3 cm ² (3x10 mm)	n.a.
Foil Overlay outer contour	without restriction / however: corners ≤ 90° must be rounded with 1 mm	n.a.
Tolerances - outer contour	+ 2.2 mm	+ 2.2 mm
Product Height	1.00 mm +/-0.30 mm	1.00 mm +/-0.30 mm
Packing Unit	1 sheet	10 m
Minimum Order QTY	1 sheet ¹	10 m
Sample QTY	≤ 1sheet ²	n.a.

¹ For Graphics the MOQ is 3 sheets.

² 20% Price Markup on sample orders <1 sheet.

CS needs to implement markup and note "Low MOQ Sample" when placing the order.

For more detailed product insights, please refer to the product information sheets. If detailed specifications regarding product tolerances (e.g. cavity dimensions for metal components or printing tolerances) are required, please contact your local Swarovski sales office. They will initiate an application request within our internal database to ensure your requirements are thoroughly addressed.

Crystal Intarsia

Crystal Intarsia brings a striking new dimension to Swarovski's Crystal Textures by merging the brilliance of Crystal Fabric with the precision of Flat Backs to create sensational 3D effects.

This innovative combination delivers radiant tactility and modern appeal, offering a fresh way to add depth, brilliance, and cultural storytelling to creative designs.

Celebrating craftsmanship, heritage, and creativity, Crystal Intarsia is perfect for fashioning unique motifs and eclectic designs that resonate with a modern, global aesthetic. Every motif can be fully customized – whether to express brand identity, create a captivating design for a special campaign, or embellishing a one-of-a-kind creation.

Crystal Intarsia

- Application: Hotfix, Coldfix, IT (Self-Adhesive), and Removable Foil (only transparent)
- Foil Colors: Transparent, Black
- Special Features Available: Graphics (only Foil Print), Foil Overlay, Unlimited
- Segments: Accessories, Apparel, Footwear, Jewelry, Interior Design, Packaging

ARTICLE EXPLANATION

412 244

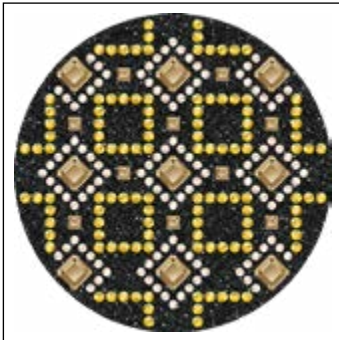

C	012-280HEM/391/001METSH/ 001GSHA/001GSHA
E	S6/S8/2400MM6/2400MM3
S	~70x70
M	20 PCS 60%

Crystal Intarsia

412 244	C	E	S	M	60%
Article number	Color of crystals	Elements For details of stone sizes and element codes, please refer to the color and product charts in the next pages of this chapter.	Motif size in mm	Minimum order quantity in pieces (PCS)	% of actual size

ORDERING EXAMPLE & PRODUCT VARIETY EXPLANATION

412 244		012	280 HEM
Article number	Type of base material	Color of base material	Color of crystals
	Hotfix	010 Transparent	Please see the respective product matrix for all available reference codes.
	C Coldfix	012 Black	
	I IT (Self-Adhesive)		
	R Removable foil		

CRYSTAL FABRIC FOR INTARSIA

412 244
Customized Motif Number

	Color of Film	
	010 Transparent (HF; CF; IT; RM)	012 Black (HF; CF; IT)
Crystal Effects		
Transparent Effects		
<input type="checkbox"/> Crystal Aurore Boreale (001 AB)	<input type="checkbox"/>	<input type="checkbox"/>
<input type="checkbox"/> Crystal Antique Pink (001 ANTP)	<input type="checkbox"/>	<input type="checkbox"/>
<input type="checkbox"/> Crystal Golden Shadow (001 GSHA)	<input type="checkbox"/>	<input type="checkbox"/>
<input type="checkbox"/> Crystal Heliotrope (001 HEL)	<input type="checkbox"/>	<input type="checkbox"/>
<input type="checkbox"/> Crystal Moonlight (001 MOL)	<input type="checkbox"/>	<input type="checkbox"/>
<input type="checkbox"/> Crystal Paradise Shine (001 PARSH)	<input type="checkbox"/>	<input type="checkbox"/>
Metallic Effects		
<input type="checkbox"/> Crystal Chrome (001 CHRM)	<input type="checkbox"/>	<input type="checkbox"/>
<input type="checkbox"/> Crystal Comet Argent Light (001 CAL)	<input type="checkbox"/>	<input type="checkbox"/>
<input type="checkbox"/> Crystal Metallic Light Gold (001 MLGLD)	<input type="checkbox"/>	<input type="checkbox"/>
<input type="checkbox"/> Crystal Metallic Sunshine (001 METSH)	<input type="checkbox"/>	<input type="checkbox"/>
Color Effects		
Metallic Effects		
<input type="checkbox"/> Jet Hematite (280 HEM)	<input type="checkbox"/>	<input type="checkbox"/>
Multicolors		
<input type="checkbox"/> Crystal & Crystal Moonlight (001 M500)	<input type="checkbox"/>	<input type="checkbox"/>

Crystal Intarsia is only available for motifs.

Crystal Intarsia is not suitable for swimwear because it is highly sensitive to seawater, sweat, and chlorine.

CRYSTAL FLAT BACKS FOR INTARSIA

2038 XILLION Rose

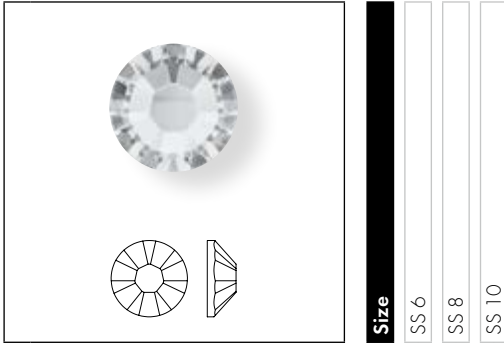

Size
SS 6
SS 8
SS 10

Crystal

Crystal M PRIM (001)

Colors

Plain Colors

- Amethyst M PRIM (204)
- Aquamarine M PRIM (202)
- Black Diamond M PRIM (215)
- Denim Blue M PRIM (266)
- Emerald M PRIM (205)
- Erinite M PRIM (360)
- Fuchsia M PRIM (502)
- Indian Siam M PRIM (327)
- Jet (280)
- Jonquil M PRIM (213)
- Light Amethyst M PRIM (212)
- Light Peach M PRIM (362)
- Light Rose M PRIM (223)
- Light Sapphire M PRIM (211)
- Light Siam M PRIM (227)
- Light Silk M PRIM (261)
- Light Turquoise M PRIM (263)
- Majestic Blue M PRIM (296)

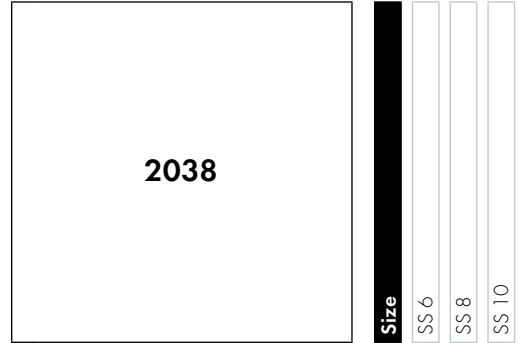

Size
SS 6
SS 8
SS 10

- Montana M PRIM (207)
 - Peridot M PRIM (214)
 - Rose M PRIM (209)
 - Ruby M PRIM (501)
 - Sapphire M PRIM (206)
 - Scarlet M PRIM (276)
 - Siam M PRIM (208)
 - Silk M PRIM (391)
 - Tanzanite M PRIM (539)
 - Vintage Rose M PRIM (319)
- Crystal Effects**
- Transparent Effects**
- Crystal Aurore Boreale M PRIM (001 AB)
 - Crystal Golden Shadow M PRIM (001 GSHA)
 - Crystal Metallic Sunshine M PRIM (001 METSH)
 - Crystal Moonlight M PRIM (001 MOL)
 - Crystal Silver Night M PRIM (001 SINI)
 - Crystal Silver Shade M PRIM (001 SSHA)
- Color Effects**
- Metallic Effects**
- Jet Hematite(280 HEM)

Crystal Intarsia

Crystal Intarsia is not suitable for swimwear because it is highly sensitive to seawater, sweat, and chlorine.

2078 XIRIUS Rose

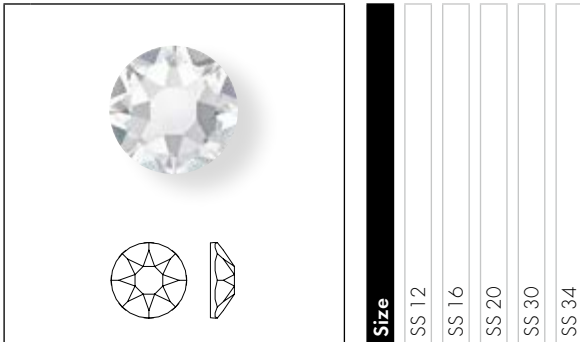

Crystal	SS 12	SS 16	SS 20	SS 30	SS 34
Crystal M PRIM (001)	■	■	■	■	■
Colors					
Plain Colors					
Amethyst M PRIM (204)	■	■	■	■	■
Aquamarine M PRIM (202)	■	■	■	■	■
Black Diamond M PRIM (215)	■	■	■	■	■
Denim Blue M PRIM (266)	■	■	■	■	■
Emerald M PRIM (205)	■	■	■	■	■
Erinte M PRIM (360)	■	■	■	■	■
Fuchsia M PRIM (502)	■	■	■	■	■
Indian Siam M PRIM (327)	■	■	■	■	■
Jet (280)	■	■	■	■	■
Jonquil M PRIM (213)	■	■	■	■	■
Light Amethyst M PRIM (212)	■	■	■	■	■
Light Peach M PRIM (362)	■	■	■	■	■
Light Rose M PRIM (223)	■	■	■	■	■
Light Sapphire M PRIM (211)	■	■	■	■	■
Light Siam M PRIM (227)	■	■	■	■	■
Light Silk M PRIM (261)	■	■	■	■	■
Light Turquoise M PRIM (263)	■	■	■	■	■
Majestic Blue M PRIM (296)	■	■	■	■	■
Montana M PRIM (207)	■	■	■	■	■
Peridot M PRIM (214)	■	■	■	■	■
Rose M PRIM (209)	■	■	■	■	■
Ruby M PRIM (501)	■	■	■	■	■
Sapphire M PRIM (206)	■	■	■	■	■
Scarlet M PRIM (276)	■	■	■	■	■
Siam M PRIM (208)	■	■	■	■	■
Silk M PRIM (391)	■	■	■	■	■
Tanzanite M PRIM (539)	■	■	■	■	■
Vintage Rose M PRIM (319)	■	■	■	■	■



Crystal Effects	SS 12	SS 16	SS 20	SS 30	SS 34
Transparent Effects					
Crystal Aurore Boreale M PRIM (001 AB)	■	■	■	■	■
Crystal Golden Shadow M PRIM (001 GSHA)	■	■	■	■	■
Crystal Metallic Sunshine M PRIM (001 METSH)	■	■	■	■	■
Crystal Moonlight M PRIM (001 MOL)	■	■	■	■	■
Crystal Silver Night M PRIM (001 SINI)	■	■	■	■	■
Crystal Silver Shade M PRIM (001 SSHA)	■	■	■	■	■
Color Effects					
Metallic Effects					
Jet Hematite (280 HEM)	■	■	■	■	■

Crystal Intarsia is not suitable for swimwear because it is highly sensitive to seawater, sweat, and chlorine.

2088 XIRIUS Rose

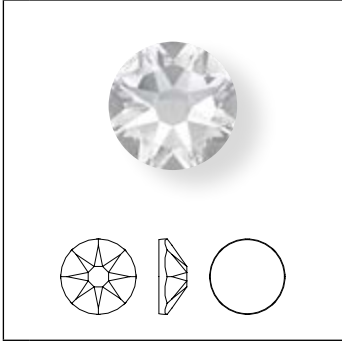

Size	SS 12	SS 16	SS 20
Crystal Effects			
Crystal Lacquer ^{PRO} Effects			
Crystal Electric Lacquer ^{PRO} Ignite Effects			
Crystal Electric Blue Ignite (001 L1341)	■	■	■
Crystal Electric Green Ignite (001 L1351)	■	■	■
Crystal Electric Orange Ignite (001 L1361)	■	■	■
Crystal Electric Pink Ignite (001 L1371)	■	■	■
Crystal Electric Violet Ignite (001 L1481)	■	■	■
Crystal Electric White Ignite (001 L1391)	■	■	■
Crystal Electric Yellow Ignite (001 L1381)	■	■	■

Crystal Effects

Crystal Lacquer^{PRO} Effects

Crystal Electric Lacquer^{PRO} Ignite Effects

- Crystal Electric Blue Ignite (001 L1341)
- Crystal Electric Green Ignite (001 L1351)
- Crystal Electric Orange Ignite (001 L1361)
- Crystal Electric Pink Ignite (001 L1371)
- Crystal Electric Violet Ignite (001 L1481)
- Crystal Electric White Ignite (001 L1391)
- Crystal Electric Yellow Ignite (001 L1381)

2400 Square Flat Back

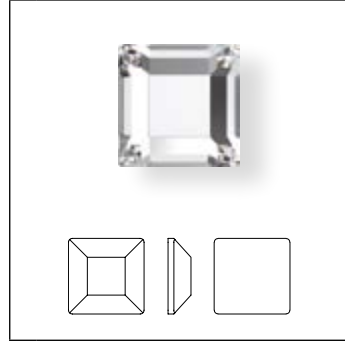

Size	3 mm	4 mm	6 mm
Crystal			
Crystal M PRIM (001)	■	■	■
Colors			
Plain Colors			
Jet (280)	■	■	■
Crystal Effects			
Transparent Effects			
Crystal Golden Shadow M PRIM (001 GSHA)	■	■	■

Crystal

- Crystal M PRIM (001)

Colors

Plain Colors

- Jet (280)

Crystal Effects

Transparent Effects

- Crystal Golden Shadow M PRIM (001 GSHA)

Crystal Intarsia is not suitable for swimwear because it is highly sensitive to seawater, sweat, and chlorine.

INSPIRATIONAL MOTIFS

84 057

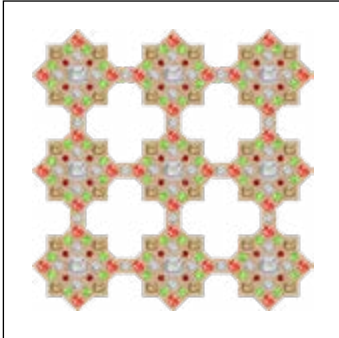

C 010-001METSH/327/214/
001L1361/001/001/001GSHA

E S6/S10/S16/2400MM6/
2400MM3/2400MM4

S ~93x93

M 12 PCS **40%**

84 058

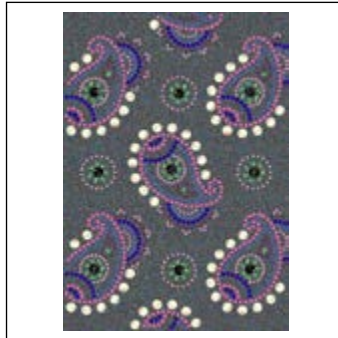

C 012-001PARSH/212/206/204/
209/296/360/001AB/280

E S6/S6/S6/S10/S10/S16/S30/
S30

S ~148x210

M 2 PCS **20%**

84 059

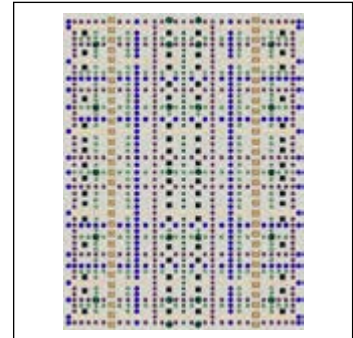

C 010-001MOL/205/204/360/
001GSHA/296/205/280/
001GSHA

E S6/S8/S8/S8/S10/S16/
2400MM3/2400MM4

S ~133x175

M 4 PCS **24%**

411 792

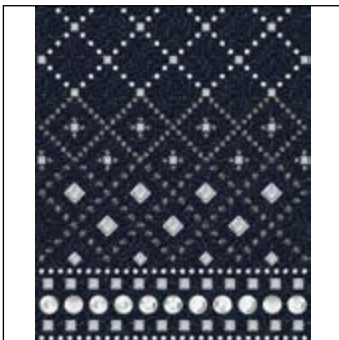

C 012-280HEM/001/215/001SINI/
001/001/001/001

E S6/S6/S10/S34/2400MM6/
2400MM3/2400MM4

S ~104x127

M 9 PCS **35%**

411 793



C 010-001GSHA/001/001/001/
001/001GSHA/001GSHA

E S6/S10/S16/S20/2400MM6/
2400MM3

S ~58x58

M 30 PCS **75%**

411 796



C 012-280HEM/001METSH/202/
502/205/001/001GSHA/280

E S16/S20/S34/S34/2400MM6/
2400MM3/2400MM4

S ~31x37

M 64 PCS **100%**

411 800

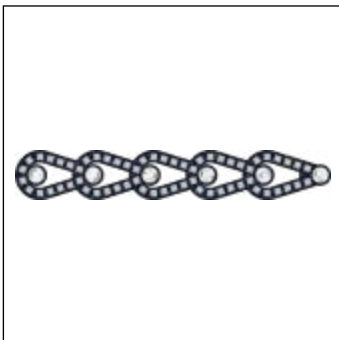

C 012-280HEM/001/001

E S34/2400MM3

S ~139x22

M 24 PCS **30%**

411 952

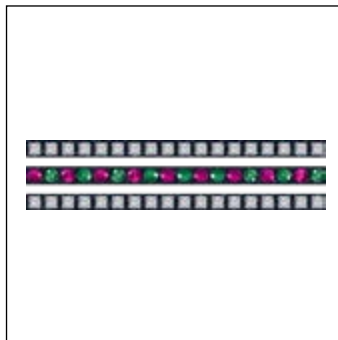

C 012-280HEM/502/360/001

E S20/S20/2400MM4

S ~99x23

M 36 PCS **40%**

412 244

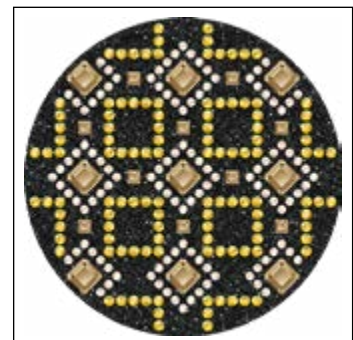

C 012-280HEM/391/001METSH/
001GSHA/001GSHA

E S6/S8/2400MM6/2400MM3

S ~70x70

M 20 PCS **60%**

TECHNICAL PRODUCT INFORMATION

Crystal Intarsia

Crystal Intarsia	
Min. motif size	(10x10 mm) 1.0 cm ²
Max. motif size	400x330 mm
Min. product width	3 mm
Min. width of holes within motif	3 mm
Min. distance between 2 motifs	3 mm
Rounding Radius (edges & angles less than =/< 90° need to be rounded off)	0.75 mm
Max. amount of different colors/sizes of Crystals	9 different Flatback elements + 1 Crystal Fabric Mixture Color + 1 Carrier Foil Color"
Min. motif size for Foil Overlay Feature	(10x10 mm) or 1.0 cm ²
Foil Overlay min./max. width outside	min. 3 mm / max. 50 mm
Foil Overlay inside (between crystal-covered surfaces)	min. 3 mm / max. 50 mm
Foil Overlay min. surface	0.3 cm ² (3x10 mm)
Foil Overlay outer contour	without restriction / however: corners ≤ 90° must be rounded with 1 mm
Tolerances - outer contour	+ 2.2 mm
Product Height	Fabric: 1.00 mm +/-0,30 mm 2038 SS6: 0.65 mm + up to 0.3 mm 2078 SS34: 2.50 mm + up to 0.3 mm
Packing Unit	1 sheet
Minimum Order QTY	1 sheet ¹
Sample QTY	≤ 1sheet ²

¹ For Graphics the MOQ is 3 sheets.

² 20% Price Markup on sample orders <1 sheet.

CS needs to implement markup and note "Low MOQ Sample" when placing the order.

For more detailed product insights, please refer to the product information sheets. If detailed specifications regarding product tolerances (e.g. cavity dimensions for metal components or printing tolerances) are required, please contact your local Swarovski sales office. They will initiate an application request within our internal database to ensure your requirements are thoroughly addressed.

Crystal Rocks Family

Engineered exclusively with full-faceted, double-pointed Chatons to achieve an unparalleled level of brilliance, the Crystal Rocks Family represents one of Swarovski's most opulent embellishment solutions to date.

This richly encrusted crystal surface is offered in three variations (Crystal Rocks, Crystal Fine Rocks and Crystal Ultrafine Rocks), providing flawless versatility for every creative vision – from bold, dramatic statements to delicate details. Its extravagant and exceptional density allows each piece to reflect light with entrancing intensity.

With their smooth surfaces and refined edges, Crystal Rocks ensure seamless application across a wide range of segments, including high-end jewelry, accessories, innovative textiles, packaging, and interior design. Every motif can be fully customized – whether to express brand identity, create a captivating design for a special campaign, or embellishing a one-of-a-kind creation.

Crystal Rocks Family

- Application: Hotfix, Coldfix, IT (Self-Adhesive), and Removable Foil (only transparent)
- Foil Colors: Transparent, Black
- Special Features Available: Graphics, Foil Overlay
- Segments: Accessories, Apparel, Footwear, Jewelry, Interior Design, Packaging

ARTICLE EXPLANATION

Crystal Rocks

351 975

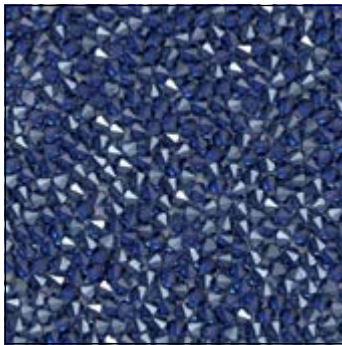

C	010 1404 NIFA
S	~45x45
M	42 PCS 100%

Crystal Fine Rocks

719 619

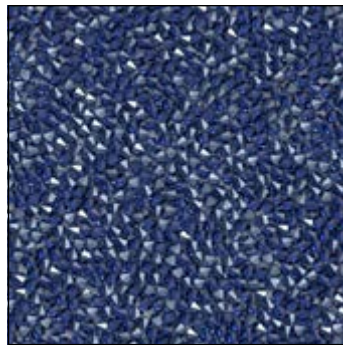

C	010 1404 NIFA
S	~45x45
M	42 PCS 100%

Crystal Ultrafine Rocks

832 691

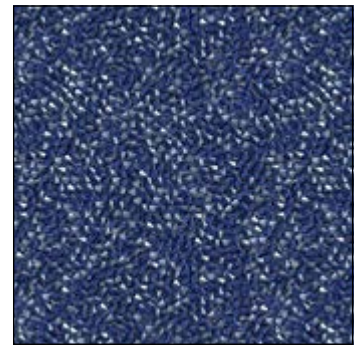

C	010 1404 NIFA
S	~45x45
M	42 PCS 100%

Crystal Rocks Family

351 975				
719 619	C	S	M	100%
832 691				
Article number	Color of crystals	Motif size in mm	Minimum order quantity in pieces (PCS)	% of actual size

ORDERING EXAMPLE & PRODUCT VARIETY EXPLANATION

351 975			
719 619		010	1404 NIFA
832 691			
Article number	Type of base material	Color of base material	Color of crystals
	Hotfix	010 Transparent	Please see the respective product matrix for all available reference codes.
	C Coldfix	012 Black	
	I IT (Self-Adhesive)		
	R Removable foil		

AVAILABLE BASE MATERIALS AND CRYSTAL COLORS & EFFECTS

72 058
74 117
89 970

Customized Motif Number

Color of Film

010 Transparent (HF; CF; IT; RM)

012 Black (HF; CF; IT)

72 058
74 117
89 970

Customized Motif Number

Color of Film

010 Transparent (HF; CF; IT; RM)

012 Black (HF; CF; IT)











- Crystal
- Crystal (001)
- Color
- Plain Color
- Erinite (360)
- Fuchsia (502)
- Jet (280)
- Light Siam (227)
- Sunflower (292)
- Vintage Rose (319)
- Swarovski ReCreated™ Colors
- ReCreated™ Dark Sapphire Nightfall (1404 NIFA)
- ReCreated™ Light Smoked Topaz (1402)
- ReCreated™ Smoked Topaz (1403)
- Crystal Effects
- Transparent Effects
- Crystal Aurore Boreale (001 AB)
- Crystal Bermuda Blue (001 BBL)
- Crystal Golden Shadow (001 GSHA)
- Crystal Heliotrope (001 HEL)
- Crystal Metallic Light Gold (001 MLGLD)
- Crystal Metallic Sunshine (001 METSH)*
- Crystal Moonlight (001 MOL)
- Crystal Paradise Shine (001 PARSH)
- Crystal Shimmer (001 971)
- Crystal Silver Shade (001 SSHA)

- Metallic Effects
- Crystal Chrome (001 CHRM)
- Crystal Comet Argent Light (001 CAL)
- Crystal Metallic Silver (001 METSI)
- Color Effects
- Transparent Effects
- Light Siam Shimmer (227 971)
- Multicolors
- Jet &
- Crystal Metallic Silver (001 M100)
- Jet &
- Crystal Comet Argent light (001M106)
- Crystal &
- Crystal Moonlight (001 M126)

* Crystal Metallic Sunshine (001 METSH) is not suitable for swimwear because effect 001 METSH is highly sensitive to seawater, sweat, and chlorine. Please note: Crystal Comet Argent Light (001 CAL) is not suitable for swimwear because effect 001 CAL is highly sensitive to seawater, sweat, and chlorine.

Crystal Fine Rocks Colorful Mixtures

<p>74 116 Customized Motif Number</p>	<p>Color of Film</p>	<p>010 Transparent (HF; CF; IT; RM)</p>	<p>012 Black (HF; CF; IT)</p>
--	-----------------------------	---	-------------------------------

Multicolors	
 Carribbean Blue (202 M155)	<input type="checkbox"/> <input type="checkbox"/>
 Deep Blue (255 M156)	<input type="checkbox"/> <input type="checkbox"/>
 Mystic Gold (319 M148)	<input type="checkbox"/> <input type="checkbox"/>
 Metallic Glow (319 M158)	<input type="checkbox"/> <input type="checkbox"/>
 Peacock (360 M150)	<input type="checkbox"/> <input type="checkbox"/>
 Disco Fever (227 M146)	<input type="checkbox"/> <input type="checkbox"/>
 Starry Night (280 M164)	<input type="checkbox"/> <input type="checkbox"/>
 Golden Spring (360 M151)	<input type="checkbox"/> <input type="checkbox"/>
 Harlequin (360 M161)	<input type="checkbox"/> <input type="checkbox"/>
 Harlequin Light (360 M162)	<input type="checkbox"/> <input type="checkbox"/>
 Silver Lights (360 M163)	<input type="checkbox"/> <input type="checkbox"/>

Crystal Rocks Family

OVERVIEW OF AVAILABLE COLORS & EFFECTS FOR THE CRYSTAL ROCKS FAMILY*

Crystal (001)



010 Transparent

Erinite (360)

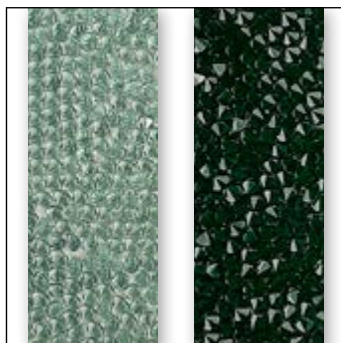

010 Transparent

012 Black

Fuchsia (502)



010 Transparent

012 Black

Jet (280)



012 Black

Light Siam (227)



010 Transparent

012 Black

Sunflower (292)



010 Transparent

012 Black

Vintage Rose (319)



010 Transparent

012 Black

Swarovski ReCreated™ Dark Sapphire
Nightfall (1404 NIFA)

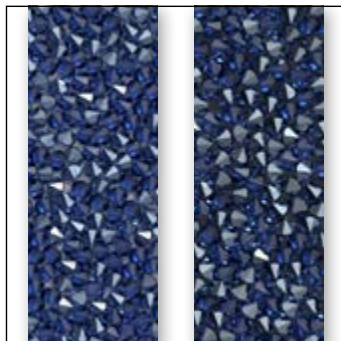

010 Transparent

012 Black

Swarovski ReCreated™ Light Smoked
Topaz (1402)



010 Transparent

012 Black

* Color illustrations in Crystal Rocks representative of all Crystal Rocks variants

Swarovski ReCreated™ Smoked Topaz (1403)

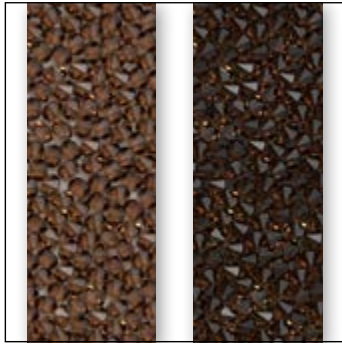

010 Transparent 012 Black

Crystal Aurore Boreale (001 AB)

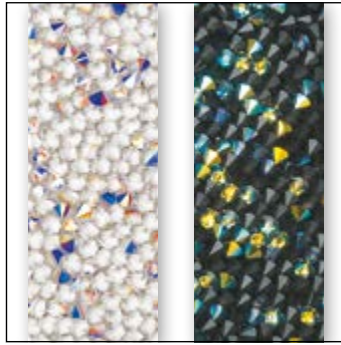

010 Transparent 012 Black

Crystal Bermuda Blue (001 BBL)



012 Black

Crystal Golden Shadow (001 GSHA)



010 Transparent

Crystal Heliotrope (001 HEL)

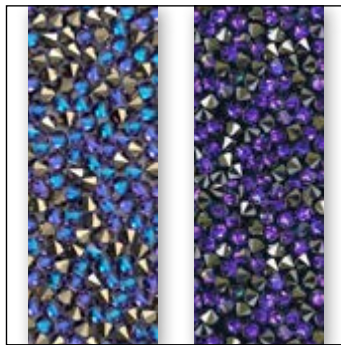

010 Transparent 012 Black

Crystal Metallic Light Gold (001 MLGLD)

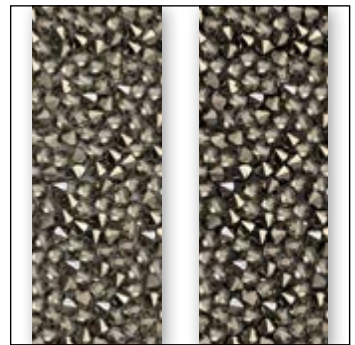

010 Transparent 012 Black

Crystal Metallic Sunshine (001 METSH)

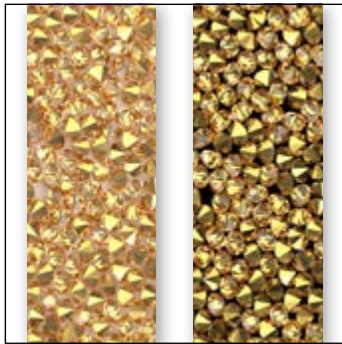

010 Transparent 012 Black

Crystal Moonlight (001 MOL)

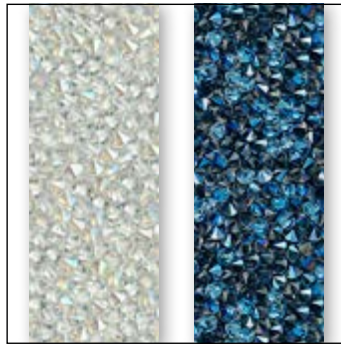

010 Transparent 012 Black

Crystal Paradise Shine (001 PARSH)

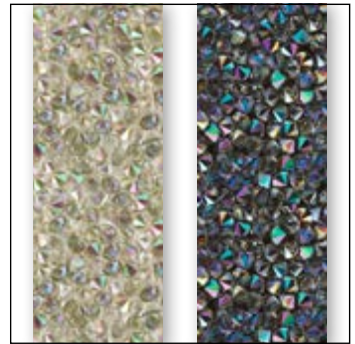

010 Transparent 012 Black

Crystal Shimmer (001 971)



012 Black

Crystal Silver Shade (001 SSHA)



010 Transparent

012 Black

Crystal Chrome (001 CHRM)

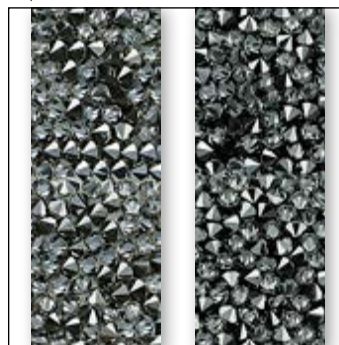

010 Transparent

012 Black

Crystal Comet Argent Light (001 CAL)

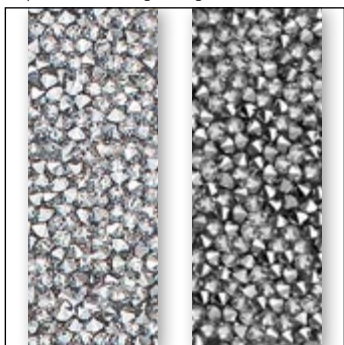

010 Transparent

012 Black

Crystal Metallic Silver (001 METSI)



010 Transparent

012 Black

Light Siam Shimmer (227 971)

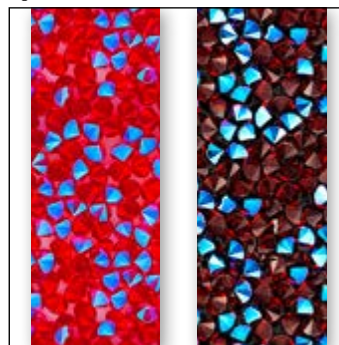

010 Transparent

012 Black

Jet & Crystal Metallic Silver (001 M100)

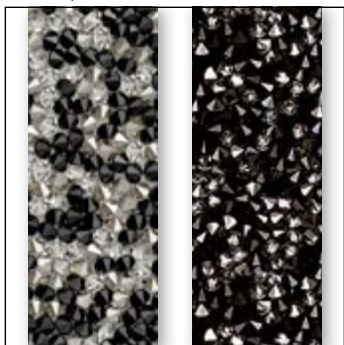

010 Transparent

012 Black

Jet & Crystal Comet Argent Light (001 M106)

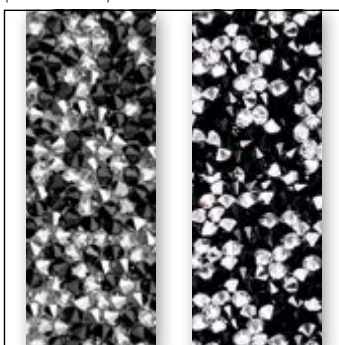

010 Transparent

012 Black

Crystal & Crystal Moonlight (001 M126)



010 Transparent

012 Black

Crystal Fine Rocks Colorful Mixtures

Carribean Blue (202 M155)

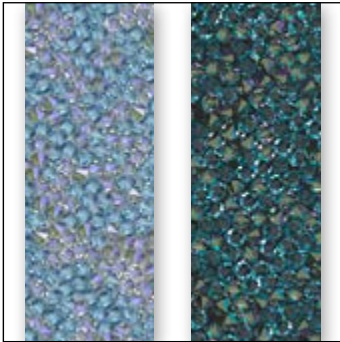

010 Transparent 012 Black

Deep Blue (255 M156)

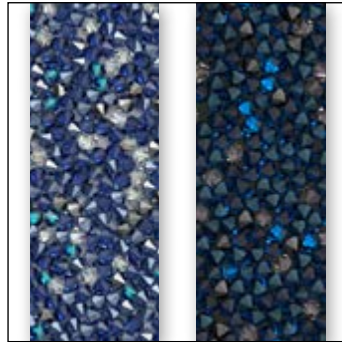

010 Transparent 012 Black

Mystic Gold (319 M148)

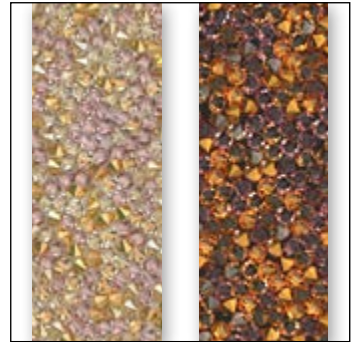

010 Transparent 012 Black

Metallic Glow (319 M158)



010 Transparent 012 Black

Peacock (360 M150)

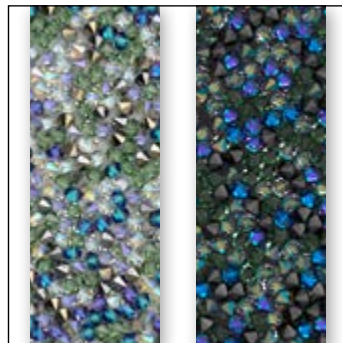

010 Transparent 012 Black

Disco Fever (227 M146)

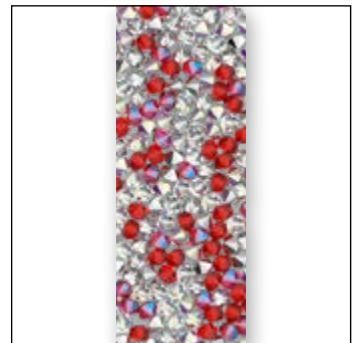

010 Transparent

Crystal Rocks Family

Starry Night (280 M164)

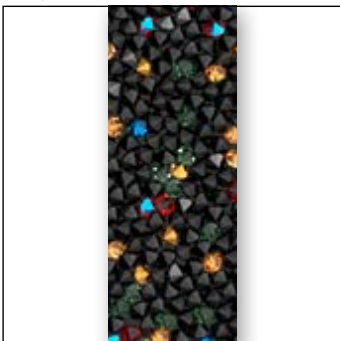

012 Black

Golden Spring (360 M151)



010 Transparent

Harlequin (360 M161)



010 Transparent

Harlequin Light (360 M162)

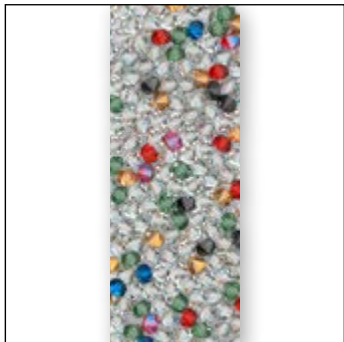

010 Transparent

Silver Lights (360 M163)

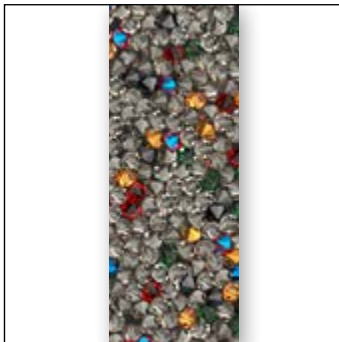

012 Black

INSPIRATIONAL MOTIFS

Crystal Rocks

72 058

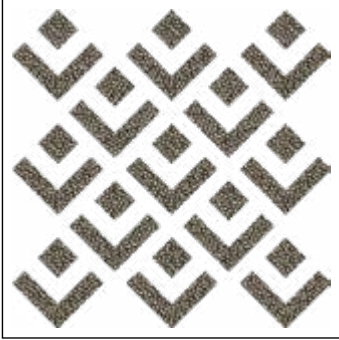

C 010-001MLGLD
S ~168x168
M 2 PCS **25%**

72 068



C 010-1402
S ~64x64
M 30 PCS **65%**

72 069



C 010-001CAL
S ~139x152
M 6 PCS **28%**

Crystal Rocks Family Inspirational Motifs

Crystal Fine Rocks

74 116

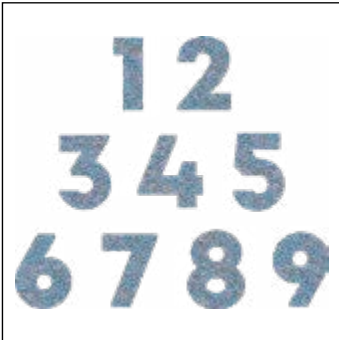

C 010-202M155
S ~118x103
M 9 PCS **35%**

74 117



C 010-227
S ~90x59
M 18 PCS **45%**

74 118

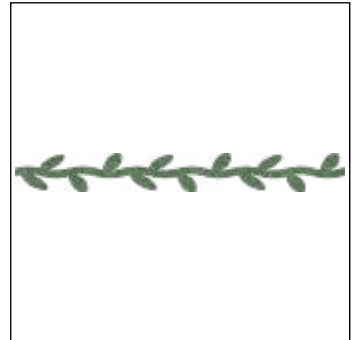

C 010-360
S ~173x20
M 22 PCS **25%**

Crystal Ultrafine Rocks

89 970

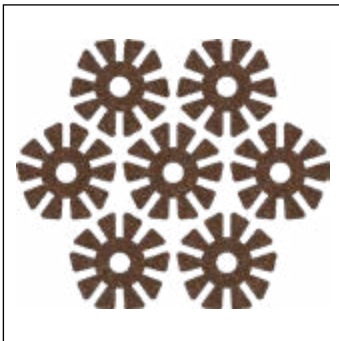

C 010-1403
S ~138x118
M 6 PCS **30%**

89 971



C 012-001METSH
S ~44x51
M 48 PCS **85%**

89 972



C 012-1404NIFA
S ~39x38
M 56 PCS **100%**

Please note: all motifs are available in certain color/film variations (see color matrix).

TECHNICAL PRODUCT INFORMATION

	Crystal Ultrafine Rocks	Crystal Fine Rocks	Crystal Rocks
Min. motif size	(8x8 mm) or 0.64 cm ²	(10x10 mm) or 1.00 cm ²	(15x15 mm) or 2.25 cm ²
Max. motif size	400x330 mm		
Min. product width	3.4 mm	4 mm	9 mm
Min. width of holes within motif	3 mm		
Min. distance between 2 motifs	3 mm		
Rounding Radius (edges & angles less than =/ < 90° need to be rounded off)	1 mm	1.35 mm	1.5 mm
Max. amount of different colors/sizes of Crystals	1 Crystal Ultrafine Rocks Color + 1 Carrier Foil Color	1 Crystal Fine Rocks Color + 1 Carrier Foil Color	1 Crystal Rocks Color + 1 Carrier Foil Color
Min. motif size for Foil Overlay Feature	(15x15 mm) or 2.25 cm ²		
Foil Overlay min./max. width outside	min. 3 mm / max. 50 mm		
Foil Overlay inside (between crystal-covered surfaces)	min. 3 mm / max. 50 mm		
Foil Overlay min. surface	0.45 cm ² (3x15 mm)		
Foil Overlay outer contour	without restriction / however: corners ≤ 90° must be rounded with 1 mm		
Tolerances - outer contour	+/- 0.4 mm	+/- 0.6 mm	+/- 0.8 mm
Product Height	1.40 +/- 0.20 mm	1.85 +/- 0.25 mm	2.40 +/- 0.30 mm
Packing Unit	1 sheet		
Minimum Order QTY	1 sheet ¹		
Sample QTY	≤ 1sheet ²		

¹ For Graphics the MOQ is 3 sheets.

² 20% Price Markup on sample orders <1 sheet.

CS needs to implement markup and note "Low MOQ Sample" when placing the order.

For more detailed product insights, please refer to the product information sheets. If detailed specifications regarding product tolerances (e.g. cavity dimensions for metal components or printing tolerances) are required, please contact your local Swarovski sales office. They will initiate an application request within our internal database to ensure your requirements are thoroughly addressed.

Crystaltex Chaton Bandings

Crystaltex Chaton Bandings bring a luxurious, eye-catching sparkle to the world of design. Composed of rows of small XILION Chatons arranged in regular or honeycomb patterns on a transparent or black Crystal Textures base, they deliver a unique look that is at once polished and powerful.

Ideal for jewelry, fashion accessories, and interior design, Crystaltex Chaton Bandings offer endless artistic freedom. Their versatile design and luminous radiance make them a brilliant choice to add a touch of individuality to any piece.

Crystaltex Chaton Bandings

- Crystaltex Chaton Bandings
- Application: Hotfix or IT (Self-Adhesive)
- Foil Colors: Transparent, Black
- Special Features Available: n.a.
- Segments: Accessories, Apparel, Jewelry, Interior Design

ARTICLE EXPLANATION

62 030

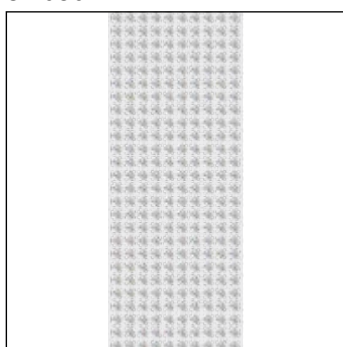

R	002-010, 088	
SS	PP 9 (1028)	
M	5 M ¹	100%

Crystaltex Chaton Bandings

62 030	R	SS	M	100 %
Article number	This article is available in 2-10 and 88 rows.	Stone size	Minimum order quantity in meters (M)	% of actual size

ORDERING EXAMPLE & PRODUCT VARIETY EXPLANATION

62 030	010	S	010	001
Article number	3-digit code for number of rows	Type of base material	Color of base material	Color of crystals
		S Hotfix I IT (Self-Adhesive)	010 Transparent 012 Black	Please see the respective product matrix for all available reference codes.

¹ Please note: the 5-meter packing unit can be delivered in batches (max. three parts with a minimum length of 0.5 meters in each batch).

62 030

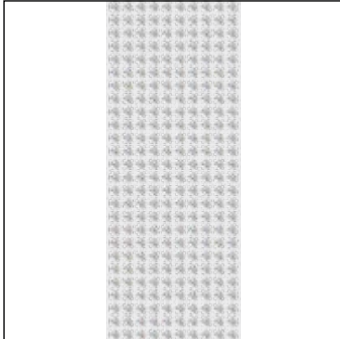

Rows	2 rows	3 rows	4 rows	5 rows	6 rows	7 rows	8 rows	9 rows	10 rows	88 rows	Color of film	010 Transparent (S_Hoflix, L_IT)	012 Black (S_Hoflix, L_IT)
------	--------	--------	--------	--------	--------	--------	--------	--------	---------	---------	---------------	----------------------------------	----------------------------

Crystal

Crystal (001)

Colors

Plain Colors

Black Diamond (215)

Greige (284)

Jet (280)

Light Colorado Topaz (246)

Light Siam (227)

Rose (209)

Silk (391)

Tanzanite (539)

Crystal Effects

Transparent Effects

Crystal Aurore Boreale (001 AB)

Crystal Golden Shadow (001 GSHA)

Crystal Silver Night (001 SINI)

Crystal Silver Shade (001 SSHA)

Color Effects

Metallic Effects

Jet Hematite (280 HEM)

Crystal (001)	■	■	■	■	■	■	■	■	■	■	■	■	■
Black Diamond (215)	■	■	■	■	■	■	■	■	■	■	■	■	■
Greige (284)	■	■	■	■	■	■	■	■	■	■	■	■	■
Jet (280)	■	■	■	■	■	■	■	■	■	■	■	■	■
Light Colorado Topaz (246)	■	■	■	■	■	■	■	■	■	■	■	■	■
Light Siam (227)	■	■	■	■	■	■	■	■	■	■	■	■	■
Rose (209)	■	■	■	■	■	■	■	■	■	■	■	■	■
Silk (391)	■	■	■	■	■	■	■	■	■	■	■	■	■
Tanzanite (539)	■	■	■	■	■	■	■	■	■	■	■	■	■
Crystal Aurore Boreale (001 AB)	■	■	■	■	■	■	■	■	■	■	■	■	■
Crystal Golden Shadow (001 GSHA)	■	■	■	■	■	■	■	■	■	■	■	■	■
Crystal Silver Night (001 SINI)	■	■	■	■	■	■	■	■	■	■	■	■	■
Crystal Silver Shade (001 SSHA)	■	■	■	■	■	■	■	■	■	■	■	■	■
Jet Hematite (280 HEM)	■	■	■	■	■	■	■	■	■	■	■	■	■

62 031 (Honeycomb)

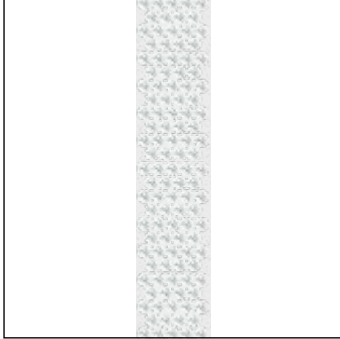

Rows	3 rows	4 rows	5 rows	6 rows	10 rows	Color of Film	010 Transparent (S_Hoflix, L_IT)	012 Black (S_Hoflix, L_IT)
------	--------	--------	--------	--------	---------	---------------	----------------------------------	----------------------------

Crystal	3 rows	4 rows	5 rows	6 rows	10 rows	Color of Film	010 Transparent (S_Hoflix, L_IT)	012 Black (S_Hoflix, L_IT)
Crystal (001)	■	■	■	■	■	■	■	■
Colors								
Plain Colors								
Black Diamond (215)	■	■	■	■	■	■	■	■
Greige (284)	■	■	■	■	■	■	■	■
Jet (280)	■	■	■	■	■	■	■	■
Light Colorado Topaz (246)	■	■	■	■	■	■	■	■
Light Siam (227)	■	■	■	■	■	■	■	■
Rose (209)	■	■	■	■	■	■	■	■
Silk (391)	■	■	■	■	■	■	■	■
Tanzanite (539)	■	■	■	■	■	■	■	■
Crystal Effects								
Transparent Effects								
Crystal Aurore Boreale (001 AB)	■	■	■	■	■	■	■	■
Crystal Golden Shadow (001 GSHA)	■	■	■	■	■	■	■	■
Crystal Silver Night (001 SINI)	■	■	■	■	■	■	■	■
Crystal Silver Shade (001 SSHA)	■	■	■	■	■	■	■	■
Color Effects								
Metallic Effects								
Jet Hematite (280 HEM)	■	■	■	■	■	■	■	■

Additional Features

Swarovski offers three innovative technologies that can be paired with products from the Crystal Textures assortment, enabling designers to create bold, personalized, and technically advanced crystal-embellished designs.

Graphic products allow imagination to take shape through high-definition printed motifs: from logos to lifelike images, any visual can be seamlessly integrated into designs. Utilizing three distinct printing methods – Foil Print, Glass Print, or a combination of both – each creation can achieve a sparkling 3D effect.

Unlimited Technology elevates precision and refinement to a new level, enabling sharper edges, seamless integration, and a luxurious finish – all while saving time by eliminating the need for rework.

Foil Overlay Technology expands creative possibilities, enabling motifs to be applied to challenging materials such as leather, and ensuring smooth, flexible integration into standard production processes.

Graphic - The Limitless Crystal Printing Technology

- Products: Crystal Fabric Motifs, Crystal Rocks Family, Crystal Intarsia (only Foil Print)
- Application: Hotfix, Coldfix, IT (Self-Adhesive), and Removable Foil (only Foil Print)
- Foil Colors: Transparent, Black, White
- Special Feature Combination: Foil Overlay, Unlimited
- Segments: Accessories, Apparel, Footwear, Jewelry, Interior Design, Packaging

GRAPHIC OFFERS THREE BRILLIANT PRINTING TECHNIQUES FOR LIMITLESS CREATIVE POWER:



Foil Print (FP)

Printed directly on the foil, underneath the crystals.

Foil Print allows for optimal brilliance. It is recommended for simple motifs and prints where blurred contours are a design element.

Please note the Print Centricity Tolerance for Foil Print is up to 0.50 mm.



Glass Print (GP)

Printed directly onto the crystals, on the surface.

Glass Print ensures an incredibly precise reproduction of the desired motif, with a soft, matte effect. It is recommended for complex motifs and prints.

Please note the Print Centricity Tolerance for Glass Print is up to 2.00 mm.



Combination of Foil & Glass Print (FP&GP)

Printed onto both foil and crystals.

This unique printing technique ensures complete customization and design innovation, with stunning depth of detail.

When overlapped, prints merge to create an illusion of vibrant 3D texture.

ARTICLE EXPLANATION

Graphic Fabric

57 439



C	FP30443 022 001M500
S	~54x46
M	85 PCS 52%

57 439	C	S	M
Article number	Color assortment FP Foil print GP Glass print	Motif size in mm	Minimum order quantity in pieces (PCS)

10

ORDERING EXAMPLE & PRODUCT VARIETY EXPLANATION

57 439	FP30443	022	001M500	XS	
Article number	Print technique FP Foil Print GP Glass Print FP & GP Foil Print & Glass Print	Type of base material 022 White 012 Black 010 Transparent	Color of film Hotfix C Coldfix I IT (Self-Adhesive) R Removable foil	Color of crystals Please see the respective product matrix for all available reference codes.	Extra Small

OVERVIEW OF ALL AVAILABLE COLORS AND EFFECTS

Graphic Fabric and Graphic Crystal Intarsia

57 439, 84 037
Customized Motif Number

Color of Film	010 Transparent (HF; CF; IT; RM)	012 Black (HF; CF; IT)	022 White (HF; CF; IT)	Print	Print on Foil ¹	Print on Glass ²
Crystal Effects						
Transparent Effects						
Crystal Aurore Boreale (001 AB)	■	■	■	■	■	■
Crystal Golden Shadow (001 GSHA)	■	■	■	■	■	■
Metallic Effects						
Crystal Comet Argent Light (001 CAL)	■	■	■	■	■	■
Color Effects						
Metallic Effects						
Jet Hemalite (280 HEM)	■	■	■	■	■	■
Multicolors						
Crystal & Crystal Moonlight (001 M500)	■	■	■	■	■	■

Graphic Rocks, Fine Rocks and Ultrafine Rocks

718 266, 74 113, 89 968
Customized Motif Number

Color of Film	010 Transparent (HF; CF; IT; RM)	012 Black (HF; CF; IT)	022 White (HF; CF; IT)	Print	Print on Foil ¹	Print on Glass
Crystal						
Crystal (001)	■	■	■	■	■	■
Colors						
Plain Colors						
Jet (280)	■	■	■	■	■	■
Crystal Effects						
Transparent Effects						
Crystal Aurore Boreale (001 AB)	■	■	■	■	■	■
Crystal Golden Shadow (001 GSHA)	■	■	■	■	■	■
Crystal Moonlight (001 MOL)	■	■	■	■	■	■
Crystal Silver Shade (001 SSHA)	■	■	■	■	■	■
Metallic Effects						
Crystal Comet Argent Light (001 CAL)	■	■	■	■	■	■
Multicolors						
Crystal & Crystal Moonlight (001 M126)	■	■	■	■	■	■

Graphic – The Limitless Crystal Printing Technology

¹ Print on Foil will not be visible on covering colors/effects and therefore this variation will not be offered in combination with covering colors/effects. Only if "Print on Foil" is possible will a combination of both (Print on Foil & Print on Glass) be offered.

² Print on Glass is not available for Crystal Intarsia.

INSPIRATIONAL MOTIFS

Graphic Fabric

57 435



C FP27196 GP27197 022 001M500
S ~104x127
M 16 PCS **33%**

57 438

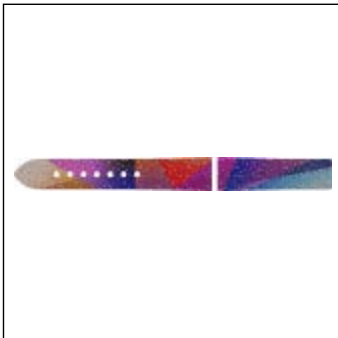

C FP30437 022 001M500
S ~167x17
M 60 PCS **33%**

57 439



C FP30443 022 001M500
S ~54x46
M 85 PCS **52%**

630 707



C FP29681 022 001GSHA
S ~104x127
M 16 PCS **33%**

630 707



C GP29684 010 001CAL
S ~104x127
M 16 PCS **33%**

630 707

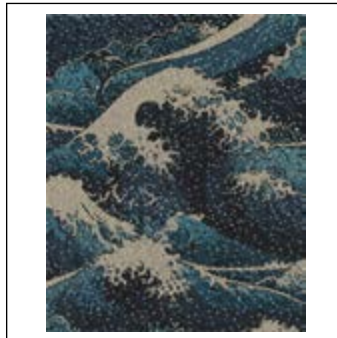

C FP29682 022 001M500
S ~104x127
M 16 PCS **33%**

10

Graphic Crystal Intarsia

84 037



C FP24894 022 001M500 202 227 208 001
E S6/S6/S6/S6
S ~96x96
M 9 PCS **33%**

84 060

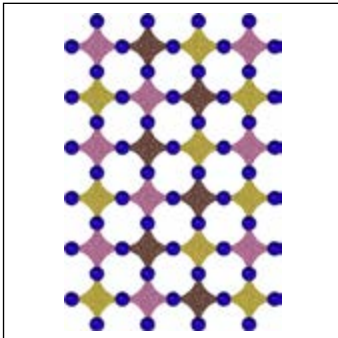

C FP30434 010 001M500 296
E S34
S ~122x179
M 4 PCS **33%**

84 061

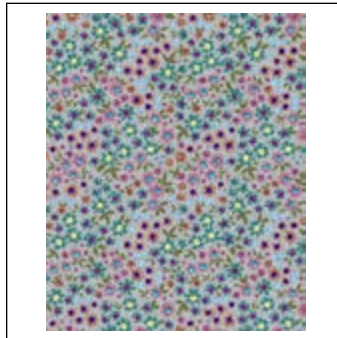

C FP30442 022 001M500 502 296 202 263 213
E S6/S6/S8/S8/S10
S ~104x127
M 9 PCS **33%**

84 062



C FP30441 022 001M500 261
001GSHA 223 209 223 001GSHA
209 227 261

E S12/S12/S12/S16/S16/S20/
S20/S20/S34

S ~80x27

M 36 PCS **35%**

412 053



C FP29044OP 010 001M500 296
001METSH 206 205 209 276

E S6/S8/S10/S12/S16/S20

S ~104x127

M 9 PCS **33%**

412 058

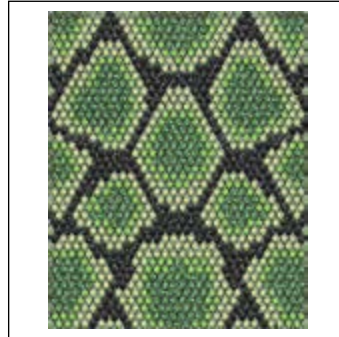

C FP29049OP 010 001M500 213
214 360

E S6/S8/S10

S ~104x127

M 9 PCS **33%**

Graphic Crystal Rocks Family

718 266



C GP29726 012 280

S ~104x127

M 9 PCS **33%**

74 113



C GP30436 010 001CAL

S ~104x127

M 9 PCS **33%**

74 114



C GP30435 010 001CAL

S ~51x63

M 30 PCS **45%**

74 115



C FP30438 022 001M126

S ~148x210

M 2 PCS **33%**

89 968



C FP30439 GP30440 022 001M126

S ~148x210

M 2 PCS **33%**

89 969



C FP30444 022 001M126

S ~115x35

M 21 PCS **33%**

Unlimited Technology

- Products: Crystal Fabric Motifs, Crystal Intarsia
- Application: Hotfix, Coldfix, IT (Self-Adhesive)
- Foil Colors: Transparent, Black
- Special Feature Combination: Graphics, Foil Overlay
- Segments: Accessories, Apparel, Footwear, Jewelry, Interior Design, Packaging

Standard Crystal Fabric

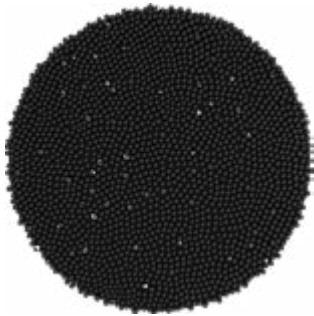

Crystal Fabric Unlimited (UL)

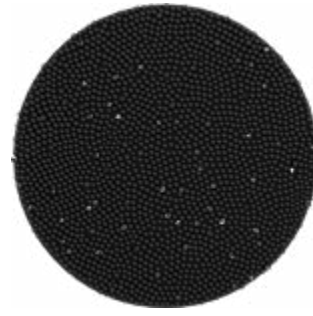

Crystal Fabric Unlimited (UL)

57 411

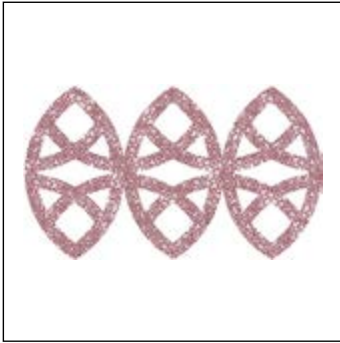

C	010-001 ANTP UL
S	~72x42
M	72 PCS 55%

57 411	C	S	M	55%
Article number	Color of crystals	Motif size in mm	Minimum order quantity in pieces (PCS)	% of actual size

Ordering Example & Product Variety Explanation

57 411		010	001 ANTP	UL
Article number	Type of base material	Color of film	Color of crystals	Unlimited
	Hotfix	010 Transparent	Please see the relevant product matrix for all available reference codes.	
	C Coldfix	012 Black		
	I IT (Self-Adhesive)			

Foil Overlay Technology

- Products: Crystal Fabric Motifs, Crystal Rocks Family, Crystal Intarsia
- Application: Hotfix
- Foil Colors: Transparent, Black
- Special Feature Combination: Graphics, Unlimited
- Segments: Accessories, Apparel, Footwear, Jewelry
- Please be aware that min. motif size for Crystal Rocks Family with FO is 15x15 mm or effective surface of 2.25 cm².

ARTICLE EXPLANATION

57 396

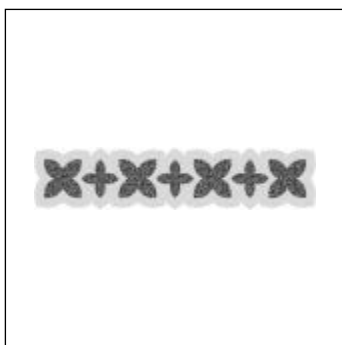

C	012-001 CAL FO
S	~149x32
M	18 PCS 25%

10

57 396	C	S	M	25%
Article number	Color of crystals	Motif size in mm	Minimum order quantity in pieces (PCS)	% of actual size

Ordering Example & Product Variety Explanation

57 396	012	001 CAL	FO
Article number	Type of base material	Color of film	Color of crystals
	Hotfix	010 Transparent 012 Black	Please see the respective product matrix for all available reference codes.
			Foil Overlay

INSPIRATIONAL MOTIFS

57 396

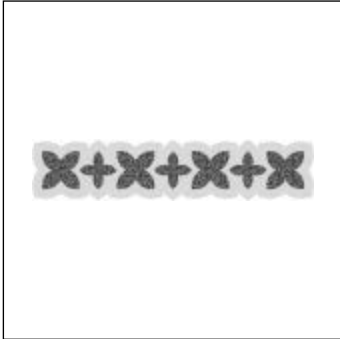

C 012-001CAL FO
S ~149x32
M 18 PCS **25%**

57 399



C 012-280HEM FO
S ~55x50
M 30 PCS **75%**

412702

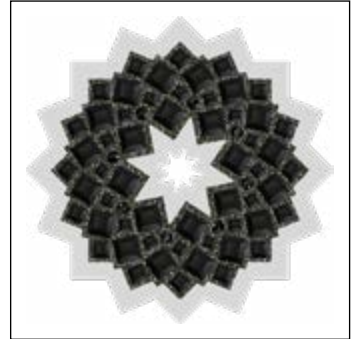

C 012-001MIGLD/280/280/
280/280 FO
E S12/2400MM6/2400MM3/
2400MM4
S ~74x74
M 20 PCS **55%**

412772

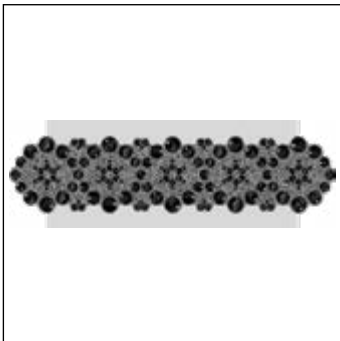

C 012-001CAL/280/280/280/280/
280 FO
E S6/S12/S20/S30/S34
S ~154x50
M 12 PCS **28%**

412773



C 010-001GSHA/001SINI/001SINI/
001SINI/001SINI FO
E S6/S12/S16/S20
S ~274x75
M 4 PCS **15%**

631092

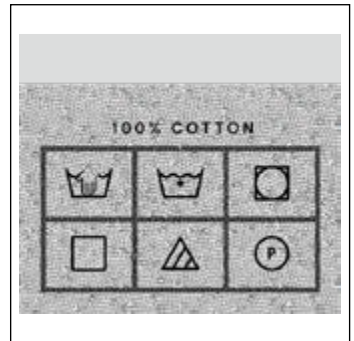

C GP30315OP 022 001M500 FO
S ~51x45
M 36 PCS **55%**

718104



C 010-319M158 FO
S ~29x28
M 99 PCS **100%**

719595

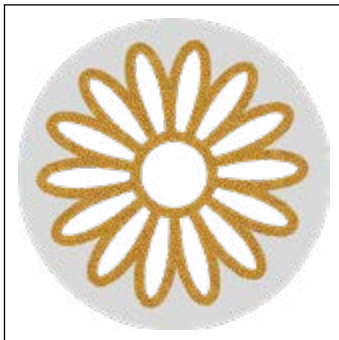

C 010-292 FO
S ~125x125
M 6 PCS **33%**

832668



C FP30313 GP30314OP 022
001M126 FO
S ~50x65
M 25 PCS **42%**

Please note: All motifs are available in certain color/film variations (see color matrix).

Special Motif Service

Special Motif Service

A special motif is a design created by the customer that differs to the Inspirational Collection. This service opens an abundance of customization possibilities and enables you to profit from Swarovski’s long-standing experience and design expertise. A range of customization options for existing motifs is available (see “Customization Possibilities”

below). You can also submit design sketches that meet your special needs, such as a brand image or an image to suit a particular sales campaign. This will then be made up according to your specifications using Computer Aided Design, which means that adjustments can be made easily according to your needs.

Ordering Process

Send your request with the drawing you wish to order to your nearest Swarovski sales office. Make sure you include all measurements for the desired motif. Please also indicate which product group your special motif applies to (Crystal Fabrics, Crystal Rocks Family or Crystal Intarsia). You will then receive a quotation including your article number,

minimum order quantity, price, and the line drawing of your special motif in PDF format. Please contact your Swarovski sales office again if any changes need to be made. Your special motif will be produced and delivered following your confirmation.

Drawing Format

Please always submit the drawing of your desired motif to represent it in the actual size you require. A small sketch, when enlarged to the desired size, will have blurred lines that will make it difficult to correctly reproduce. Pictures or drawings representing 100% size of the design or very good quality scans in JPG, BMP, or DXF format will ensure that

we have clear data to work with. These can also be sent via email. If sending a sewing pattern, please include the whole pattern and not just sections. When the sketch is submitted as a copy by email, please include a scale legend (e.g. copy/scan with a ruler next to the drawing). This will ensure that the desired size of the motif can be identified.

Required information for Graphic Motifs

data format contour/outline	vector graphics (.dxf, .ai, .eps, .dwg)
data format picture	raster image format (.tiff, .pdf, .psd, .png) / vector format (.ai, .eps, .pdf)
picture resolution & size	min. 300dpi (real size)
colors	RGB or CMYK
fonts	convert text to paths/outlines

Product Tolerances

It is generally possible to draw motifs with a minimum gap between the outlines. However, due to the tolerance level of the crystals being applied onto carrier film, the final Crystal Textures motifs may differ from the sketches or prints in relation to the motifs’ outline.

Therefore, the motif, and by extension, the product itself, may be subject to individual variations with each reproduction. These variations are caused by technical production related factors. As these variations are not deemed to be defects, warranty claims are excluded and

Swarovski assumes no liability whatsoever in connection with them.

Please note that for the Graphics feature, due to the different print methods (print on foil or glass), the colors may vary. Possible color variations are more noticeable on single-color motifs than on images with many different colors.

You can find the details of all product tolerances in the Product Information Sheets.

Terms & Conditions

Special productions are generally offered to all our customers if these are deemed to be feasible and comply with our General Terms and Conditions. Please note special

productions are subject to acceptance by Swarovski and ordering a design does not automatically grant exclusive production of this design for the customer.

Product Application

If detailed information on the possible motif tolerances (e.g., cavity production for metal parts) and print tolerances (e.g., offset or color tolerance) is required, please contact your local Swarovski sales office who will enter an application request into our application database.

For detailed application information, please refer to the Application Manual or contact your Swarovski sales office. Please take care with deep-colored fabrics and artificial leather (e.g., denim and alcantara). Some fabrics may bleed after application or washing.

Customization Possibilities of the respective product groups

	CRYSTAL FABRIC MOTIFS	CRYSTAL ULTRAFINE ROCKS	CRYSTAL FINE ROCKS	CRYSTAL ROCKS	CRYSTAL INTARSIA
Min. motif size	(10x10 mm) or 1.0 cm ²	(8x8 mm) or 0.64 cm ²	(10x10 mm) or 1.00 cm ²	(15x15 mm) or 2.25 cm ²	(10x10 mm) or 1.0 cm ²
Max. motif size	980x330 mm Standard 400x330 mm (Graphics, UL, FO)		400x330 mm		
Min. product width	3 mm	3.4 mm	4 mm	9 mm	3 mm
Min. width of holes within motif	3 mm				
Min. distance between 2 motifs	3 mm				
Rounding Radius (edges & angles less than =/< 90° need to be rounded off)	0.75 mm	1 mm	1.35 mm	1.5 mm	0.75 mm
Max. amount of different colors/ sizes of Crystals	1 Crystal Fabric Mixture Color + 1 Carrier Foil Color	1 Crystal Ultrafine Rocks Color + 1 Carrier Foil Color	1 Crystal Fine Rocks Color + 1 Carrier Foil Color	1 Crystal Rocks Color + 1 Carrier Foil Color	9 different Flat- back elements + 1 Crystal Fabric Mixture Color + 1 Carrier Foil Color
Min. motif size for Foil Overlay Feature	(10x10 mm) or 1.0 cm ²	(15x15 mm) or 2.25 cm ²	(15x15 mm) or 2.25 cm ²	(15x15 mm) or 2.25 cm ²	(10x10 mm) or 1.0 cm ²
Foil Overlay min./max. width outside	min. 3 mm / max. 50 mm				
Foil Overlay inside (between crystal- covered surfaces)	min. 3 mm / max. 50mm				
Foil Overlay Minimum surface	0.3 cm ² (3x10 mm)	0.45 cm ² (3x15 mm)	0.45 cm ² (3x15 mm)	0.45 cm ² (3x15 mm)	0.3 cm ² (3x10 mm)
Foil Overlay outer contour	without restriction / however: corners ≤ 90° must be rounded with 1 mm				
Tolerances - outer contour	+ 2.2 mm	+/- 0.4 mm	+/- 0.6 mm	+/- 0.8 mm	+ 2.2 mm
Product Height	1.00 mm +/- 0.30 mm	1.40 mm +/- 0.20 mm	1.85 mm +/- 0.25 mm	2.40 mm +/- 0.30 mm	Fabric: 1.00 mm +/-0.30 mm 2038 SS6: 0.65 mm + up to 0.30 mm 2078 SS34: 2.50 mm + up to 0.30 mm



Linked Crystal Components

Linked Crystal Components combine precision-cut brilliance with innovative design. Loose crystals are linked together with metal and expertly crafted to reflect light while showcasing design flexibility. Unlocking boundless creative potential, they are divided into two sub-categories: Crystal Mesh and Cupchains, both suitable for use in a wide range of segments from textiles to accessories.

A masterclass in versatility, designed for effortless embellishment, they enable designers to craft intricate patterns and surfaces with unmatched ease.

Crystal Mesh

The pioneering innovation, Crystal Mesh, made its dazzling debut in 1993. A shimmering metal mesh embedded with loose crystals and offered in a brilliant range of colors and finishes, Crystal Mesh exudes pure luxury with its radiant finish and fluid flexibility. Designed for creative ease it is available in two application formats: Hotfix, which is applied using heat, and No Hotfix, suitable for hand or machine sewing. With its smooth texture and luminous sparkle, Crystal Mesh transforms any design into a statement of style.

From striking single-color designs to bespoke or standard motifs, Crystal Mesh unlocks limitless possibilities for design innovation. Motifs can feature up to nine colors and are available across Crystal Standard Mesh, Crystal Standard Mesh Mini, and Crystal Fine Mesh. Depending on the intended use, it can be supplied as full sheets or in rows.

Swarovski now offers nine distinctive variations of Crystal Mesh, each crafted to deliver unparalleled design flexibility bringing the most imaginative visions to life.

Crystal Mesh Product Overview

CRYSTAL MESH STANDARD & INSPIRATIONAL MOTIF

40 000

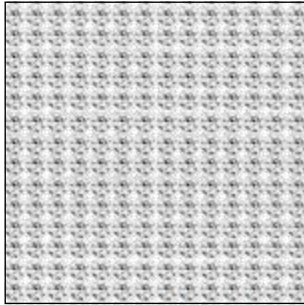

40 001

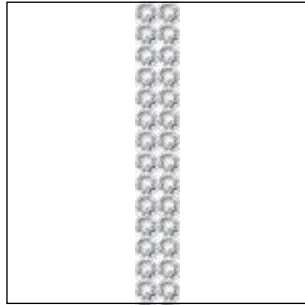

548 641



CRYSTAL MESH STANDARD MINI & INSPIRATIONAL MOTIF

40 400

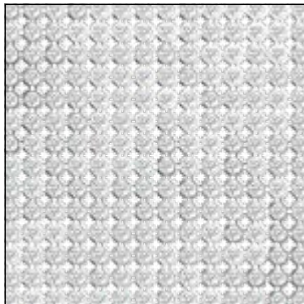

40 401

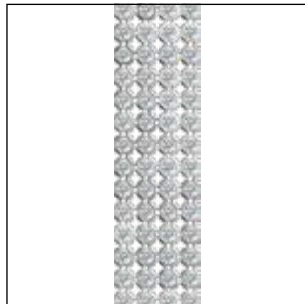

118 563

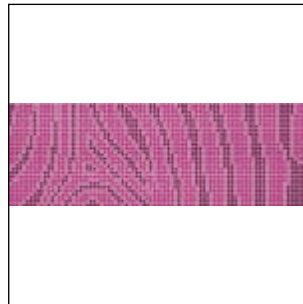

CRYSTAL FINE MESH & INSPIRATIONAL MOTIF

40 600

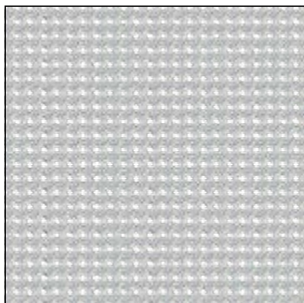

40 601

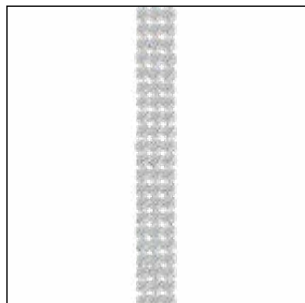

550 854

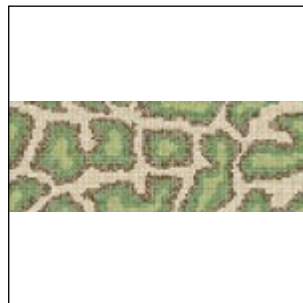

CRYSTAL HONEYCOMB MESH

40 800

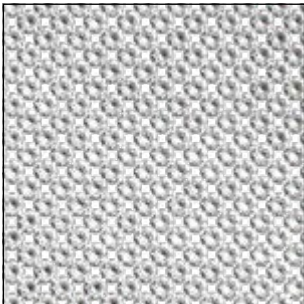

CRYSTAL CAVIAR MESH

40 500

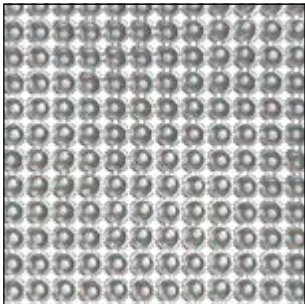

40 501

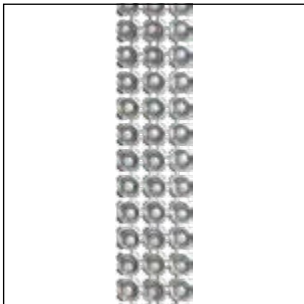

CRYSTAL LIGHT MESH

40 900

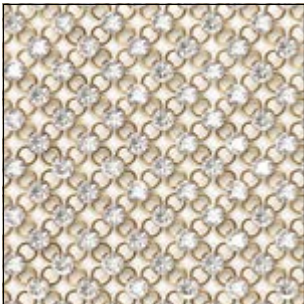

40 901



CRYSTAL LIGHT MESH MINI

40 910



40 911

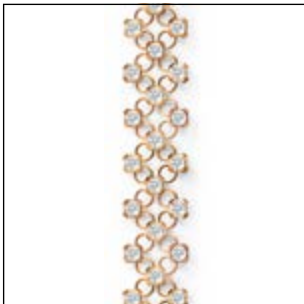

CRYSTAL COLORÉE MESH

40 200



40 201

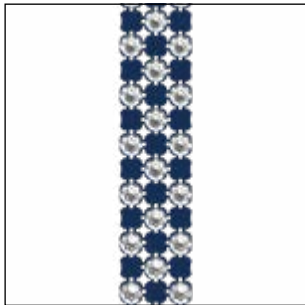

CRYSTAL COLORÉE MESH MINI

40 210



40 211

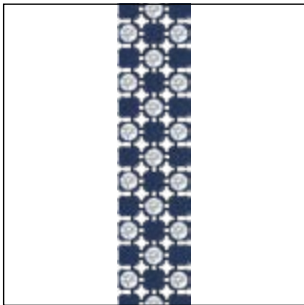

Crystal Mesh Standard

ARTICLE EXPLANATION - SHEETS

40 000

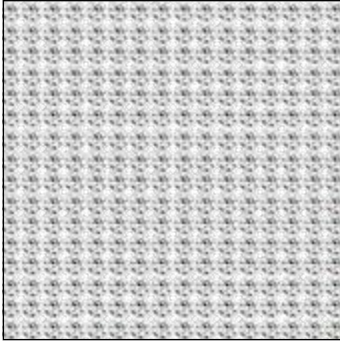

SH	100
S	~500x200
E	1088 PP 21
M	1 SH 100%

Crystal Mesh Standard

40 000	SH	S	E	M	100%
Article number	Sheet	Sheet size in mm	Elements Crystals and stone size used	Minimum order quantity in sheets (SH)	% of actual size

ORDERING EXAMPLE & PRODUCT VARIETY EXPLANATION

40 000	100	082	001	NOHF
Article number	Sheet	Color of casing	Color of crystals	Hotfix Technology
	100 Standard sheet (~500x200 mm)	012 Black ¹ 081 Gold ² 082 Silver ² 088 Stainless Steel	Please see the respective product matrix for all available reference codes.	NOHF Without Hotfix glue / With Hotfix glue

¹ Base material for 012 Black-colored casing: aluminum

² Base material for 081 Gold and 082 Silver-colored casing: brass

ARTICLE EXPLANATION - ROWS

40 001

**R** 002-033**E** 1088 PP 21**M** 10 M **100%**

40 001	R	E	M	100%
Article number	Number of rows This article is available from 2 to 33 rows.	Elements Crystal and stone size used	Minimum order quantity in meters (M)	% of actual size

11

ORDERING EXAMPLE & PRODUCT VARIETY EXPLANATION

40 001	002	082	001	HF
Article number	3-digit code for number of rows	Color of casing 012 Black ¹ 081 Gold ² 082 Silver ² 088 Stainless Steel	Color of crystals Please see the respective product matrix for all available reference codes	Hotfix Technology NOHF Without Hotfix glue / With Hotfix glue

¹ Base material for 012 Black-colored casing: aluminum² Base material for 081 Gold and 082 Silver-colored casing: brass

40 000

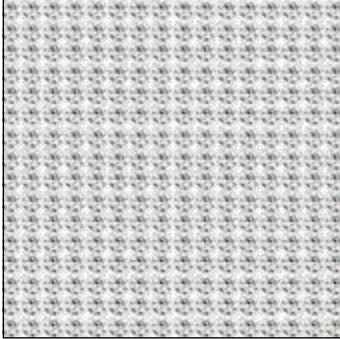

SH 100
S ~500x200
E 1088 PP 21
M 1 SH **100%**

40 001



R 002-033
E 1088 PP 21
M 10 M **100%**

Crystal Mesh Standard

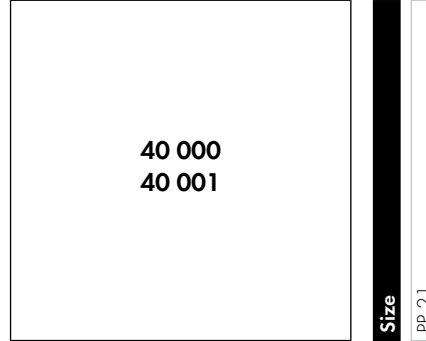

Crystal

Crystal F (001)

Colors

Plain Colors

Amethyst F (204)

Aquamarine F (202)

Black Diamond F (215)

Chrysolite F (238)

Citrus Green F (337)

Denim Blue F (266)

Emerald F (205)

Greige F (284)

Iris F (219)

Jet (280)

Light Amethyst F (212)

Light Colorado Topaz F (246)

Light Rose F (223)

Light Sapphire F (211)

Light Siam F (227)

Light Topaz F (226)

Light Turquoise F (263)

Majestic Green F (336)

Montana F (207)

Rose F (209)

Rose Peach F (262)

Sapphire F (206)

Scarlet F (276)

Siam F (208)

Silk F (391)

Tanzanite F (539)

Vintage Rose F (319)

Violet F (371)

40 000
40 001

Size

PP 21

Opal Colors

White Opal F (234)

Swarovski ReCreated™ Colors

ReCreated™ Dark Jonquil F (1407)

ReCreated™ Dark Sapphire F (1404)

ReCreated™ Ice Blue F (1405)

ReCreated™ Light Smoked Topaz F (1402)

ReCreated™ Peridot F (1408)

ReCreated™ Smoked Topaz F (1403)

TCF™ Colors

Dark Orange F (1202 TCF™)

Dark Rose F (1201 TCF™)

40 000
40 001

Size

PP 21

Crystal Effects

Transparent Effects

Crystal AB F (001 AB)

Crystal Golden Shadow F (001 GSHA)

Crystal Moonlight F (001 MOL)

Crystal Silver Night F (001 SINI)

Crystal Silver Shade F (001 SSHA)

Metallic Effects

Crystal Aurum F (001 AUR)

Color Effects

Metallic Effects

Jet Hematite F (280 HEM)

AVAILABLE CASING COLORS

Crystal Mesh Standard is available with black, gold and silver-colored casings, as well as Stainless Steel casing.



012 Black



081 Gold



082 Silver



088 Stainless Steel

Crystal Mesh Standard Mini

ARTICLE EXPLANATION - SHEETS

40 400 Crystal Mesh Standard Mini

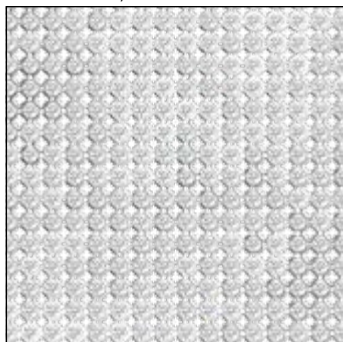

SH	100
S	~500x200
SS	1028 PP 13
M	1 SH 100%

Crystal Mesh Standard Mini

40 400	SH	S	E	M	100%
Article number	Sheet	Sheet size in mm	Elements Crystals and stone size used	Minimum order quantity in sheets (SH)	% of actual size

ORDERING EXAMPLE & PRODUCT VARIETY EXPLANATION

40 400	100	082	001	NOHF
Article number	Sheet	Color of casing	Color of crystals	Hotfix Technology
	100 Standard sheet (-500x200 mm)	012 Black ² 081 Gold ¹ 082 Silver ¹ R1018 Zinc Yellow ² R4010 Telemagenta ² R5002 Marine Blue ²	Please see the respective product matrix for all available reference codes.	NOHF Without Hotfix glue / With Hotfix glue

¹ Base material for 081 Gold and 082 Silver-colored casing: brass

² Base material for RAL-colored casing: aluminum

ARTICLE EXPLANATION - ROWS

40 401 Crystal Mesh Standard Mini

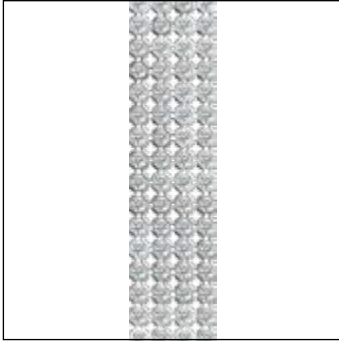

R 002-033

SS 1028 PP 13

M 10 M 100%

40 401	R	E	M	100%
Article number	Number of rows This article is available from 2 to 33 rows.	Elements Crystal and stone size used	Minimum order quantity in meters (M)	% of actual size

11

ORDERING EXAMPLE & PRODUCT VARIETY EXPLANATION

40 401	002	081	001	HF
Article number	3-digit code for number of rows	Color of casing 012 Black ² 081 Gold ¹ 082 Silver ¹ R1018 Zinc Yellow ² R4010 Telemagenta ² R5002 Marine Blue ²	Color of crystals Please see the respective product matrix for all available reference codes	Hotfix Technology NOHF Without Hotfix glue / With Hotfix glue

40 400 Crystal Mesh Standard Mini

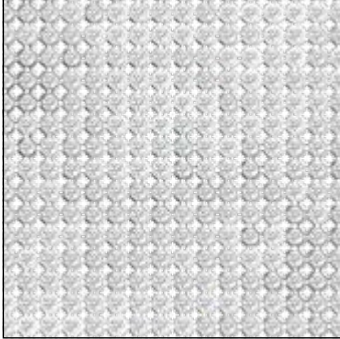

SH 100
S ~500x200
SS 1028 PP 13
M 1 SH **100%**

40 401 Crystal Mesh Standard Mini

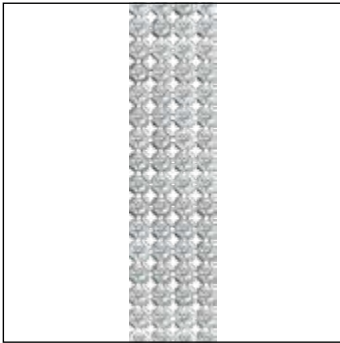

R 002-033
SS 1028 PP 13
M 10 M **100%**

Crystal Mesh Standard Mini

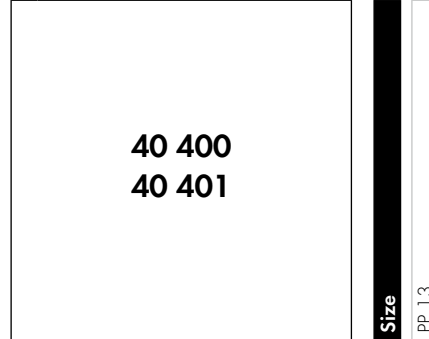

Crystal	
	Crystal F (001)
Colors	
Plain Colors	
	Amethyst F (204)
	Aquamarine F (202)
	Black Diamond F (215)
	Chrysolite F (238)
	Denim Blue F (266)
	Emerald F (205)
	Greige F (284)
	Iris F (219)
	Jet (280)
	Light Amethyst F (212)
	Light Colorado Topaz F (246)
	Light Rose F (223)
	Light Sapphire F (211)
	Light Siam F (227)
	Light Topaz F (226)
	Light Turquoise F (263)
	Montana F (207)
	Rose F (209)
	Rose Peach F (262)
	Sapphire F (206)
	Scarlet F (276)
	Siam F (208)
	Silk F (391)
	Tanzanite F (539)
	Vintage Rose F (319)
	Violet F (371)

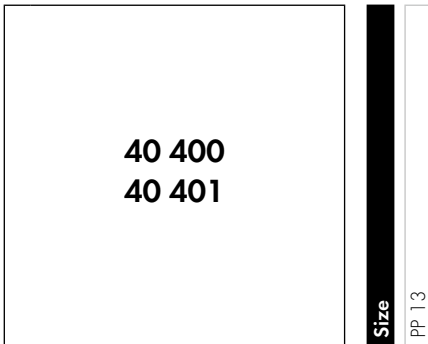

- Opal Colors**
- White Opal F (234)
- Swarovski ReCreated™ Colors**
- ReCreated™ Dark Jonquil F (1407)
- ReCreated™ Dark Sapphire F (1404)
- ReCreated™ Ice Blue F (1405)
- ReCreated™ Light Smoked Topaz F (1402)
- ReCreated™ Peridot F (1408)
- ReCreated™ Smoked Topaz F (1403)
- TCF™ Colors**
- Dark Orange F (1202 TCF™)
- Dark Rose F (1201 TCF™)

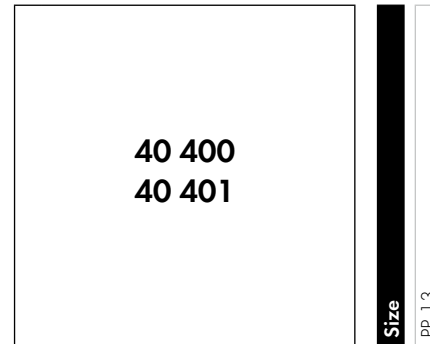

- Crystal Effects**
- Transparent Effects**
- Crystal Aurore Boreale F (001 AB)
- Crystal Golden Shadow F (001 GSHA)
- Crystal Moonlight F (001 MOL)
- Crystal Silver Night F (001 SINI)
- Crystal Silver Shade F (001 SSHA)
- Metallic Effects**
- Crystal Aurum F (001 AUR)
- Color Effects**
- Metallic Effects**
- Jet Hematite (280 HEM)

AVAILABLE CASING COLORS

Crystal Mesh Standard Mini is available as standard with gold, silver and black-colored casings, as well as the RAL colors Zinc Yellow (R1018), Telemagenta (R4010) and Marine Blue (R5002).

All further RAL Classic and RAL Design Colors are possible as customized solution.

Please note that due to UV sensitivity, white is not offered. Silver and light colors are not recommended for daily usage outdoors.



012 Black



081 Gold



082 Silver

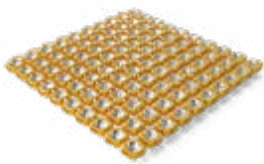

R1018 Zinc Yellow

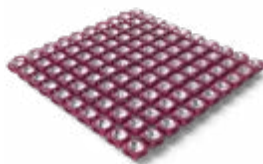

R4010 Telemagenta

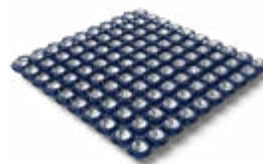

R5002 Marine Blue

Crystal Fine Mesh

ARTICLE EXPLANATION - SHEETS

40 600

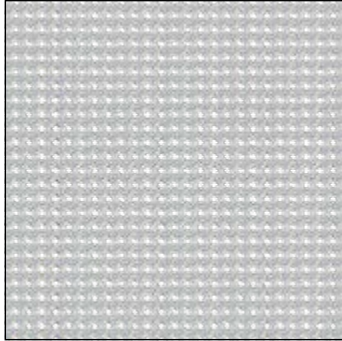

SH	100
S	~500x200
E	1028 ¹ PP 9
M	1 SH 100%

Crystal Fine Mesh

40 600	SH	S	E	M	100%
Article number	Sheet	Sheet size in mm	Elements Crystals and stone size used	Minimum order quantity in sheets (SH)	% of actual size

ORDERING EXAMPLE & PRODUCT VARIETY EXPLANATION

40 600	100	082	001	NOHF
Article number	100 Standard Sheet (500x200 mm)	Color of casing 081 Gold ² 082 Silver ²	Color of crystals Please see the respective product matrix for all available reference codes.	Hotfix Technology NOHF Without Hotfix glue / With Hotfix glue

¹ A different sorting of the 1028 based on tolerances is needed for the production of Fine Mesh. Leadtimes and MOQ will therefore depend on the availability of the sorted item.

² Base material for 081 Gold and 082 Silver-colored casing: brass

ARTICLE EXPLANATION - ROWS

40 601

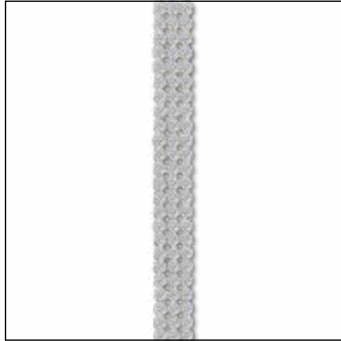

R	003-033	
E	1028 ¹ PP 9	
M	10 M	100%

40 601	R	E	M	100%
Article number	Number of rows	Elements Crystals and stone size used	Minimum order quantity in meters (M)	% of actual size

11

ORDERING EXAMPLE & PRODUCT VARIETY EXPLANATION

40 601	003	082	001	HF
Article number	3-digit code for number of rows	Color of casing 081 Gold ² 082 Silver ²	Color of crystals Please see the respective product matrix for all available reference codes.	Hotfix Technology NOHF Without Hotfix glue / With Hotfix glue

¹ A different sorting of the 1028 based on tolerances is needed for the production of Fine Mesh. Leadtimes and MOQ will therefore depend on the availability of the sorted item.

² Base material for 081 Gold and 082 Silver-colored casing: brass

40 600

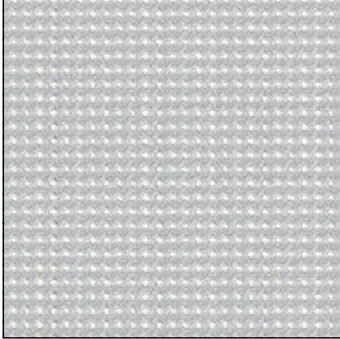

SH 100
S ~500x200
E 1028¹ PP 9
M 1 SH **100%**

40 601

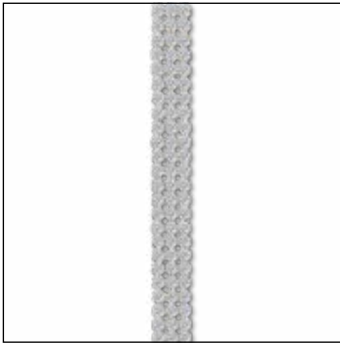

R 003-033
E 1028¹ PP 9
M 10 M **100%**

Crystal Fine Mesh

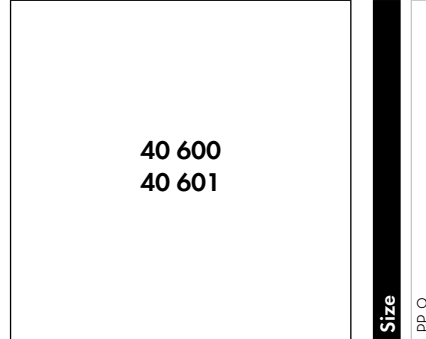

Crystal	
	Crystal F (001)
Colors	
Plain Colors	
	Amethyst F (204)
	Aquamarine F (202)
	Black Diamond F (215)
	Chrysolite F (238)
	Denim Blue F (266)
	Emerald F (205)
	Greige F (284)
	Iris F (219)
	Jet (280)
	Light Amethyst F (212)
	Light Colorado Topaz F (246)
	Light Rose F (223)
	Light Sapphire F (211)
	Light Siam F (227)
	Light Topaz F (226)
	Light Turquoise F (263)
	Majestic Green F (336)
	Montana F (207)
	Rose F (209)
	Rose Peach F (262)
	Sapphire F (206)
	Scarlet F (276)
	Siam F (208)
	Silk F (391)
	Tanzanite F (539)
	Vintage Rose F (319)
	Violet F (371)

¹ A different sorting of the 1028 based on tolerances is needed for the production of Fine Mesh. Leadtimes and MOQ will therefore depend on the availability of the sorted item.

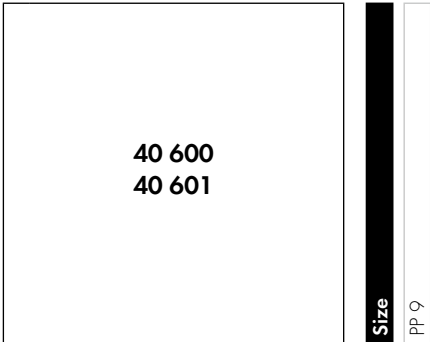

- Opal Colors**
 - White Opal F (234)
- Swarovski ReCreated™ Colors**
 - ReCreated™ Dark Jonquil F (1407)
 - ReCreated™ Dark Sapphire F (1404)
 - ReCreated™ Ice Blue F (1405)
 - ReCreated™ Light Smoked Topaz F (1402)
 - ReCreated™ Peridot F (1408)
 - ReCreated™ Smoked Topaz F (1403)
- TCF™ Colors**
 - Dark Orange F (1202 TCF™)
 - Dark Rose F (1201 TCF™)

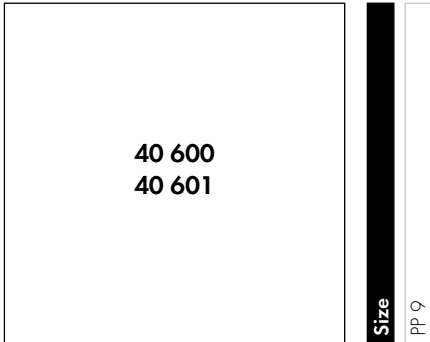

- Crystal Effects**
- Transparent Effects**
 - Crystal AB F (001 AB)
 - Crystal Golden Shadow F (001 GSHA)
 - Crystal Moonlight F (001 MOL)
 - Crystal Silver Night F (001 SINI)
 - Crystal Silver Shade F (001 SSHA)
- Metallic Effects**
 - Crystal Aurum F (001 AUR)
- Color Effects**
- Metallic Effects**
 - Jet Hematite F (280 HEM)

AVAILABLE CASING COLORS

Crystal Fine Mesh is available with gold and silver-colored casing.

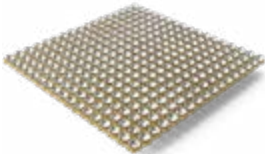

081 Gold



082 Silver

Crystal Mesh Motifs

With the ability to blend up to nine crystal colors, Crystal Mesh Motifs offer a breathtaking canvas for creative expression. From logos and signature patterns to symbolic motifs, each piece is tailored to reflect your creative vision. Capturing light with mesmerizing brilliance, the Motifs add depth and radiance to any design. Perfect for fashion, accessories, and jewelry, Crystal Mesh Motifs transform creations into extraordinary statements of elegance.

Crystal Mesh Motifs

EXAMPLE CRYSTAL MESH STANDARD

548 876



C	012-280/001GSHA/262/ 001MOL/001AB/226/1402/ 1201/319
E	PP21/PP21/PP21/PP21/PP21/ PP21/PP21/PP21/PP21
S	~254x192
M	1 PCS 17%

Crystal Mesh Motifs

548 876	C	E	S	M	17%
Article number generated by SC Office	Color assortment	Elements For details, please refer to the sizes overview at the end of the Collection	Motif size in mm	Minimum order quantity in pieces (PCS)	% of actual size

ORDERING EXAMPLE & PRODUCT VARIETY EXPLANATION

548 876	012	280	001GSHA	262	HF
Article number generated by SC Office	Color of casing 012 Black ¹ 081 Gold ² 082 Silver ²	Crystal color corresponding to element 1; color of the most frequently used element in the motif. Please see the respective product matrix for all available reference codes.	Crystal color corresponding to element 2; color of the second most frequently used element in the motif.	Crystal color corresponding to element 3; color of the third most frequently used element in the motif.	Hotfix Technology NOHF Without Hotfix glue / With Hotfix glue

¹ Base material for 012 Black-colored casing: aluminum

² Base material for 081 Gold and 082 Silver-colored casing: brass

Casing color 012 is only available for Standard Mesh Motifs and Standard Mesh Mini Motifs

SPECIAL MOTIF SERVICE

A special motif is a design created by the customer that differs to the Crystal Mesh Standard Collection. This service opens up an abundance of customization possibilities and enables you to profit from Swarovski's long-standing experience and design expertise. A range of customization options for existing motifs is available (see

"Customization Possibilities" below). You can also submit design sketches that meet your special needs, such as a brand image or an image for a particular sales campaign. This will then be made up according to your specifications using Computer Aided Design, which means that adjustments can be made easily according to your needs.

Customization Possibilities

- Motifs are available for Crystal Mesh Standard, Crystal Mesh Standard Mini and Crystal Fine Mesh only
- Up to nine colors are possible per Crystal Mesh Motif
- Creation of a new motif (ex. Logos, brand names, patterns...)
- Change of size of a mesh sheet / rows (minimum size: 4x4 rows; maximum size: 1x1 m depending on mesh type)
- Change of size of an existing motif

Ordering Process

Send your request with the drawing you wish to order to your nearest Swarovski sales office.

Make sure you include all measurements for the desired motif. Please also indicate:

- Which product group your special motif applies to (Standard Mesh, Standard Mesh Mini, Fine Mesh)
- Which casing color you wish to use (081, 082, 012 and RAL colors depending on which Mesh type)

- Whether Hotfix should be applied or not
- You will then receive a quotation including your article number, minimum order quantity, price, and the line drawing of your special motif in PDF format.

Please contact your Swarovski sales office again if any changes are required. Your special motif will be produced and delivered following your confirmation.

Please Note

Please always submit the drawing of your desired motif to represent it in the actual size you require. A small sketch, when enlarged to the desired size, will have blurred lines that will make it difficult to correctly reproduce. Pictures or drawings representing 100% size of the design or very good quality scans in JPG, BMP, or DXF format will ensure that we have clear data to work with. These can also be sent via email. If sending a sewing pattern, please include the whole pattern and not just sections. When the sketch is submitted as a copy by email, please include a scale

legend (e.g. copy/scan with a ruler next to the drawing). This will ensure that the desired size of the motif can be identified.

Special productions are generally offered to all our customers if these are deemed to be feasible and comply with our General Terms and Conditions. Please note ordering of a design does not grant exclusive production of this design to the customer.

CRYSTAL MESH STANDARD INSPIRATIONAL MOTIFS

41 006

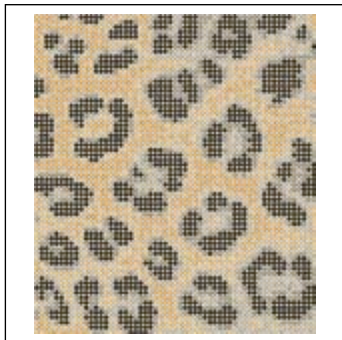

C 081-280/246/001SSHA/
001GSHA/001SINI
E PP21/PP21/PP21/PP21/PP21
S ~168x192
M 2 PCS **22%**

548 865

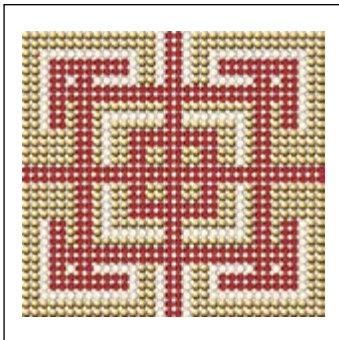

C 081-001AUR/276/001
E PP21/PP21/PP21
S ~100x94
M 10 PCS **40%**

548 641



C 082-001/206/226/207/205/
391/1003/214
E PP21/PP21/PP21/PP21/PP21/
PP21/PP21/PP21
S ~109x109
M 4 PCS **38%**

Crystal Mesh Motifs

548 874

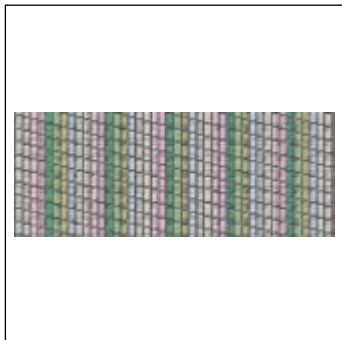

C 012-280HEM/001MOL/391/
223/209/211/205/1408/1407
E PP21/PP21/PP21/PP21/PP21/
PP21/PP21/PP21/PP21
S ~501x195
M 1 PCS **12%**

548 893



C 082-001/1408/336/223/209/
001SINI/1201
E PP21/PP21/PP21/PP21/PP21/
PP21/PP21
S ~386x77
M 2 PCS **11%**

548 877



C 012-215/001GSHA/203/246/
227/1402/1403/1404/280
E PP21/PP21/PP21/PP21/PP21/
PP21/PP21/PP21/PP21
S ~298x53
M 3 PCS **14%**

CRYSTAL MESH STANDARD MINI INSPIRATIONAL MOTIFS

118 527

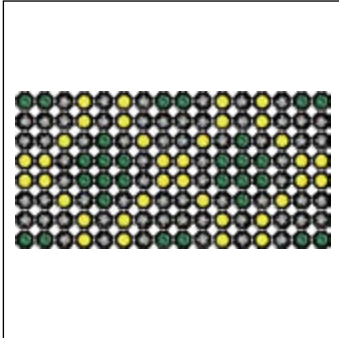

C 012-280HEM/226/336
E PP13/PP13/PP13
S ~47x24
M 80 PCS **88%**

118 574

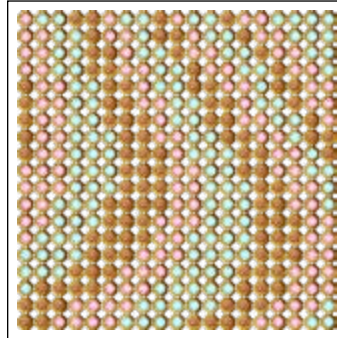

C 081-202/209/1202
E PP13/PP13/PP13
S ~56x56
M 24 PCS **75%**

118 580

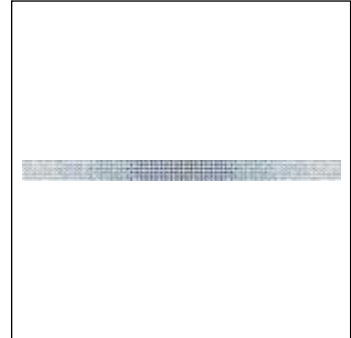

C 082-211/1405/1404/001/207
E PP13/PP13/PP13/PP13/PP13
S ~280x18
M 11 PCS **17%**

118 546

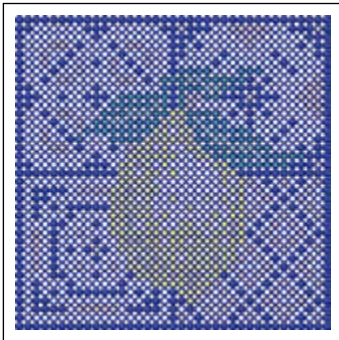

C R5002-001/1404/226/001GSHA/
205/319/1407/1408
E PP13/PP13/PP13/PP13/PP13/
PP13/PP13/PP13
S ~109x109
M 4 PCS **38%**

118 575

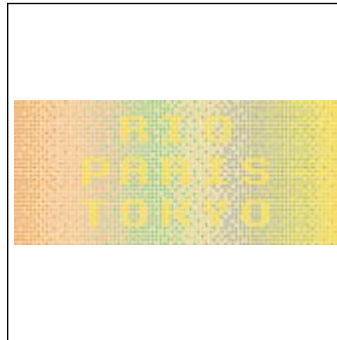

C R1018-226/1408/209/206/539/
211/263/262
E PP13/PP13/PP13/PP13/PP13/
PP13/PP13/PP13
S ~254x112
M 1 PCS **17%**

118 563

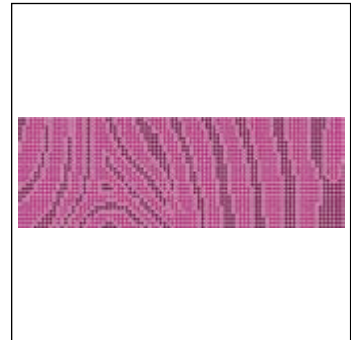

C R4010-1201/280/215
E PP13/PP13/PP13
S ~254x86
M 2 PCS **17%**

CRYSTAL FINE MESH INSPIRATIONAL MOTIFS

550 866



C 082-391/226/280/539/001AUR/
1408/1202/205/238
E PP9/PP9/PP9/PP9/PP9/PP9/PP9/
PP9/PP9
S ~145x116
M 3 PCS **30%**

550 861

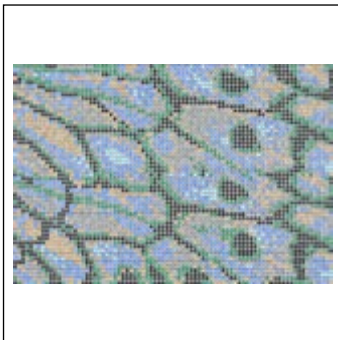

C 082-206/215/280/205/
001GSHA/202
E PP9/PP9/PP9/PP9/PP9/PP9
S ~140x96
M 6 PCS **30%**

550 708

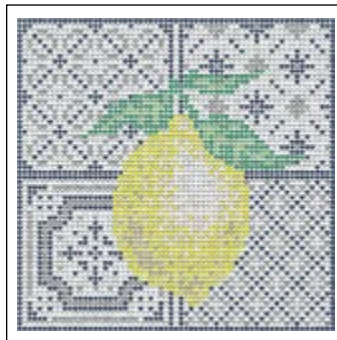

C 082-001/207/001SINI/226/
205/391/1407/1408
E PP9/PP9/PP9/PP9/PP9/PP9/PP9/
PP9
S ~110x108
M 4 PCS **38%**

550 890

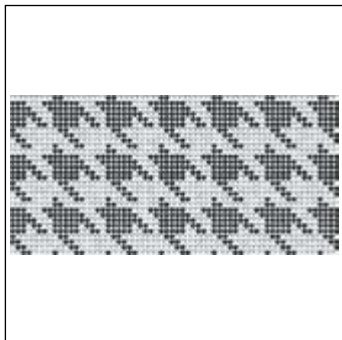

C 082-001/280
E PP9/PP9
S ~109x52
M 12 PCS **40%**

550 854



C 081-001/280/280HEM/205/
336/1408
E PP9/PP9/PP9/PP9/PP9/PP9
S ~198x72
M 4 PCS **21%**

550 864



C 081-001/227/262/319/208/
226
E PP9/PP9/PP9/PP9/PP9/PP9
S ~217x191
M 2 PCS **20%**

Crystal Honeycomb Mesh

ARTICLE EXPLANATION - SHEETS

40 800 Crystal Honeycomb Mesh

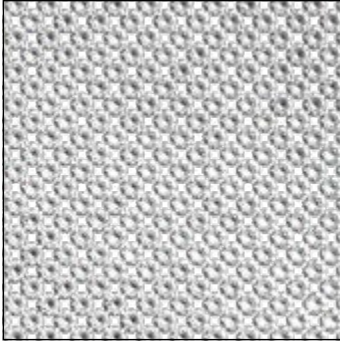

SH	100
S	~500x200
E	1088 PP 21
M	1 SH 100%

40 800	SH	S	E	M	100%
Article number	Sheet	Sheet size in mm	Elements Crystals and stone size used	Minimum order quantity in sheets (SH)	% of actual size

11

ORDERING EXAMPLE & PRODUCT VARIETY EXPLANATION

40 800	100	081	001	NOHF	
Article number	Sheet	Color of casing		Hotfix Technology	
	100 Standard sheet (~500x200 mm)	012	Black ¹	Please see the relevant product matrix for all available referenve codes	
		081	Gold ²		NOHF Without Hotfix glue
		082	Silver ²		/ With Hotfix glue

¹ Base material for 012 Black-colored casing: aluminium

² Base material for 081 Gold and 082 Silver-colored casing: brass

40 800 Crystal Honeycomb Mesh

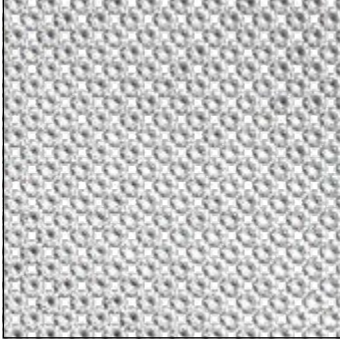

SH	100
S	~500x200
E	1088 PP 21
M	1 SH 100%

Crystal Honeycomb Mesh

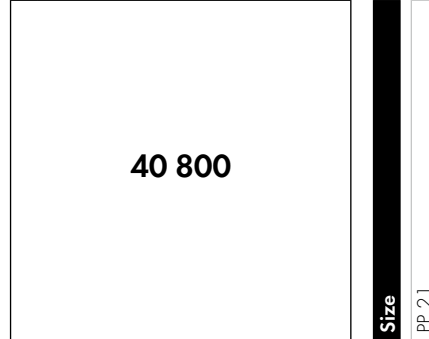

Crystal	
	Crystal F (001)
Colorx	
Plain Colors	
	Amethyst F (204)
	Aquamarine F (202)
	Black Diamond F (215)
	Chrysolite F (238)
	Citrus Green F (337)
	Denim Blue F (266)
	Emerald F (205)
	Greige F (284)
	Iris F (219)
	Jet (280)
	Light Amethyst F (212)
	Light Colorado Topaz F (246)
	Light Rose F (223)
	Light Sapphire F (211)
	Light Siam F (227)
	Light Topaz F (226)
	Light Turquoise F (263)
	Majestic Green F (336)
	Montana F (207)
	Peridot F (214)
	Rose F (209)
	Rose Peach F (262)
	Sapphire F (206)
	Scarlet F (276)
	Siam F (208)
	Silk F (391)
	Tanzanite F (539)
	Vintage Rose F (319)
	Violet F (371)

40 800

Size

PP 21

- Opal Colors
- White Opal F (234)
- Swarovski ReCreated™ Colors
- ReCreated™ Dark Jonquil F (1407)
- ReCreated™ Dark Sapphire F (1404)
- ReCreated™ Ice Blue F (1405)
- ReCreated™ Light Smoked Topaz F (1402)
- ReCreated™ Peridot F (1408)
- ReCreated™ Smoked Topaz F (1403)
- TCF™ Colors
- Dark Rose F (1201 TCF™)
- Dark Orange F (1202 TCF™)

40 800

Size

PP 21

- Crystal Effects
- Transparent Effects
- Crystal Aurore Boreale F (001 AB)
- Crystal Golden Shadow F (001 GSHA)
- Crystal Moonlight F (001 MOL)
- Crystal Silver Night F (001 SINI)
- Crystal Silver Shade F (001 SSHA)
- Metallic Effects
- Crystal Aurum F (001 AUR)
- Color Effects
- Metallic Effects
- Jet Hematite F (280 HEM)

AVAILABLE CASING COLORS

Crystal Honeybomb Mesh is available as standard with gold and silver.

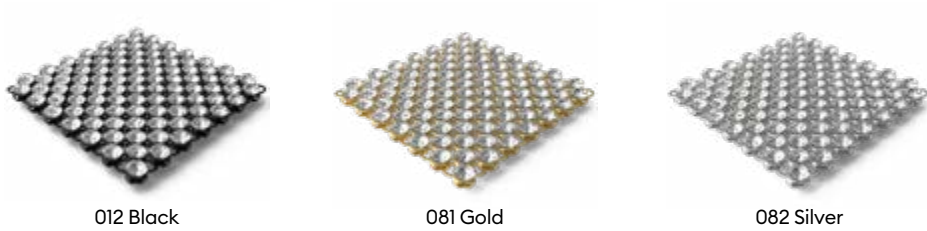

Crystal Light Mesh & Crystal Light Mesh Mini

ARTICLE EXPLANATION - SHEETS

40 900 Crystal Light Mesh

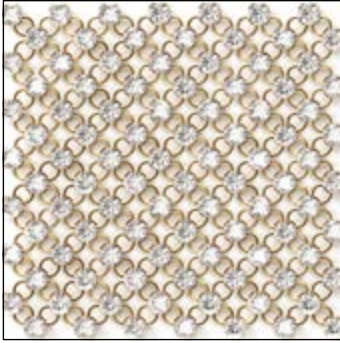

SH	100
S	~500x200
E	1088 PP21
M	1 SH 100%

40 910 Crystal Light Mesh Mini



SH	100
S	~500x200
E	1028 PP13
M	1 SH 100%

Crystal Light Mesh & Crystal Light Mesh Mini

40 900 40 910	SH	S	E	M	100%
Article number	Sheet	Sheet size in mm	Elements Crystals and stone size used	Minimum order quantity in sheets (SH)	% of actual size

ORDERING EXAMPLE & PRODUCT VARIETY EXPLANATION

40 900 40 910	100	081	001	NOHF
Article number	Sheet	Color of casing		Hotfix Technology
	100 Standard sheet (~500x200 mm)	081 Gold ¹ 082 Silver ¹	Please see the relevant product matrix for all available referenve codes	NOHF Without Hotfix glue / With Hotfix glue

¹ Base material for 081 Gold and 082 Silver-colored casing: brass

ARTICLE EXPLANATION - ROWS

40 901 Crystal Light Mesh



R	003-010
E	1088 PP21
M	10 M 100%

40 911 Crystal Light Mesh Mini



R	003-010
E	1028 PP13
M	10 M 100%

40 901 40 911	R	E	M	100%
Article number	Number of rows	Elements	Minimum order quantity in meters (M)	% of actual size
	This article is available from 3 to 10 rows.	Crystals and stone sized used		

11

ORDERING EXAMPLE & PRODUCT VARIETY EXPLANATION

40 901 40 911	003	081	001	NOHF
Article number	3-digit code for number of rows	Color of casing	Color of crystals	Hotfix Technology
		081 Gold ¹ 082 Silver ¹	Please see the relevant product matrix for all available reference codes	NOHF Without Hotfix glue / With Hotfix glue

¹ Base material for 081 Gold and 082 Silver-colored casing: brass

40 900 Crystal Light Mesh

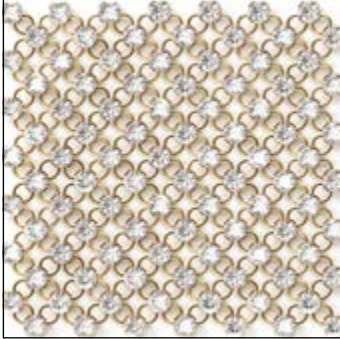

SH	100
S	~500x200
E	1088 PP21
M	1 SH 100%

40 901 Crystal Light Mesh



R	003-010
E	1088 PP21
M	10 M 100%

Crystal Light Mesh & Crystal Light Mesh Mini

40 910 Crystal Light Mesh Mini



SH	100
S	~500x200
E	1028 PP13
M	1 SH 100%

40 911 Crystal Light Mesh Mini

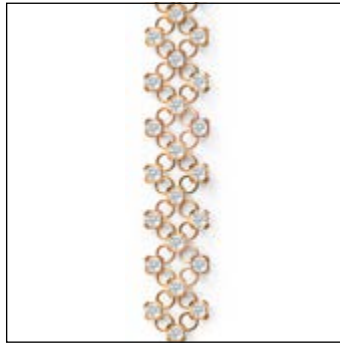

R	003-010
E	1028 PP13
M	10 M 100%

40 900/40 901
40 910/40 911

Size
40 900/40 901 Crystal Light Mesh
PP 21
40 910/40 911 Crystal Light Mesh Mini
PP 13

Crystal	40 900/40 901 Crystal Light Mesh	40 910/40 911 Crystal Light Mesh Mini
Crystal F (001)	■	■
Colors		
Plain Colors		
Amethyst F (204)	■	■
Aquamarine F (202)	■	■
Black Diamond F (215)	■	■
Chrysolite F (238)	■	■
Citrus Green F (337)	■	■
Denim Blue F (266)	■	■
Emerald F (205)	■	■
Greige F (284)	■	■
Iris F (219)	■	■
Jet (280)	■	■
Light Amethyst F (212)	■	■
Light Colorado Topaz F (246)	■	■
Light Rose F (223)	■	■
Light Sapphire F (211)	■	■
Light Siam F (227)	■	■
Light Topaz F (226)	■	■
Light Turquoise F (263)	■	■
Majestic Green F (336)	■	■
Montana F (207)	■	■
Rose F (209)	■	■
Rose Peach F (262)	■	■
Sapphire F (206)	■	■
Scarlet F (276)	■	■
Siam F (208)	■	■
Silk F (391)	■	■
Tanzanite F (539)	■	■
Vintage Rose F (319)	■	■
Violet F (371)	■	■
Opal Colors		
White Opal F (234)	■	■

40 900/40 901
40 910/40 911

Size
40 900/40 901 Crystal Light Mesh
PP 21
40 910/40 911 Crystal Light Mesh Mini
PP 13

Swarovski ReCreated™ Colors	40 900/40 901 Crystal Light Mesh	40 910/40 911 Crystal Light Mesh Mini
ReCreated™ Dark Jonquil F (1407)	■	■
ReCreated™ Dark Sapphire F (1404)	■	■
ReCreated™ Ice Blue F (1405)	■	■
ReCreated™ Light Smoked Topaz F (1402)	■	■
ReCreated™ Peridot F (1408)	■	■
ReCreated™ Smoked Topaz F (1403)	■	■
TCF™ Colors		
Dark Orange F (1202 TCF™)	■	■
Dark Rose F (1201 TCF™)	■	■
Crystal Effects		
Transparent Effects		
Crystal AB F (001 AB)	■	■
Crystal Golden Shadow F (001 GSHA)	■	■
Crystal Moonlight F (001 MOL)	■	■
Crystal Silver Night F (001 SINI)	■	■
Crystal Silver Shade F (001 SSHA)	■	■
Metallic Effects		
Crystal Aurum F (001 AUR)	■	■
Color Effects		
Metallic Effects		
Jet Hematite F (280 HEM)	■	■

AVAILABLE CASING COLORS

Crystal Light Mesh and Light Mesh Mini are available with gold and silver-colored casings.

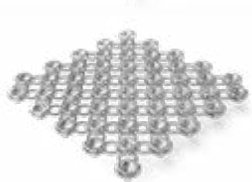

081 Gold

082 Silver

Crystal Mesh Colorée & Crystal Mesh Colorée Mini

Crystal Mesh Colorée & Crystal Mesh Colorée Mini

ARTICLE EXPLANATION - SHEETS

40 200 Crystal Mesh Colorée

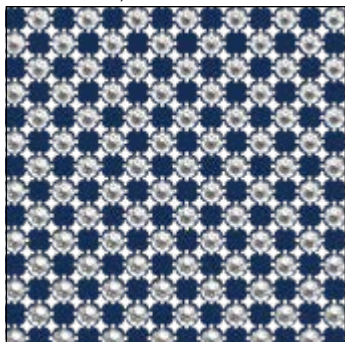

SH	100
S	~500x200
E	1088 PP 21
M	1 SH 100%

40 210 Crystal Mesh Colorée Mini

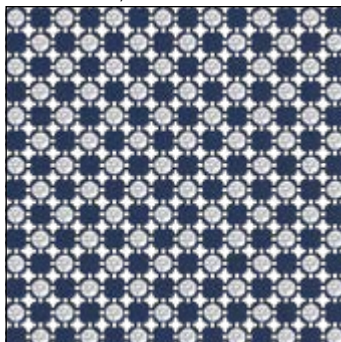

SH	100
S	~500x200
E	1028 PP13
M	1 SH 100%

40 200 40 210	SH	S	E	M	100%
Article number	Sheet	Sheet size in mm	Elements Crystals and stone size used	Minimum order quantity in sheets (SH)	% of actual size

11

ORDERING EXAMPLE & PRODUCT VARIETY EXPLANATION

40 200 40 210	100	082	001	NOHF
Article number	Sheet	Color of casing	Color of crystals	Hotfix Technology
	100 Standard sheet (~500x200 mm)	081 Gold ¹ 082 Silver ¹ R9005 Jet Black ² R5022 Night Blue ² R1015 Light Ivory ²	Please see the relevant product matrix for all available reference codes.	NOHF Without Hotfix glue / With Hotfix glue

¹ Base material for 081 Gold and 082 Silver-colored casing: brass

² Base material for RAL colors: aluminium

ARTICLE EXPLANATION - ROWS

40 201 Crystal Mesh Colorée



R	003-010	
E	1088 PP 21	
M	10 M	100%

40 211 Crystal Mesh Colorée Mini

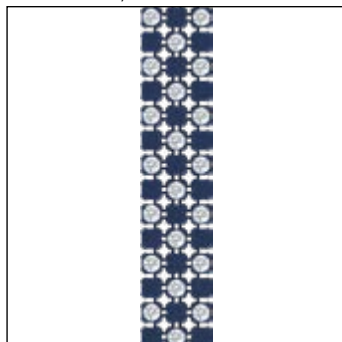

R	003-010	
E	1028 PP13	
M	10 M	100%

40 201 40 211	R	E	M	100%
Article number	Number of rows	Elements	Minimum order quantity in meters (M)	% of actual size
	This article is available from 3 to 10 rows.	Crystals and stone size used		

ORDERING EXAMPLE & PRODUCT VARIETY EXPLANATION

40 201 40 211	003	082	001	NOHF
Article number	3-digit code for number of rows	Color of casing	Color of crystals	Hotfix Technology
		081 Gold ¹ 082 Silver ¹ R9005 Jet Black ² R5022 Night Blue ² R1015 Light Ivory ²	Please see the relevant product matrix for all available reference codes.	NOHF Without Hotfix glue / With Hotfix glue

¹ Base material for 081 Gold and 082 Silver-colored casing: brass

² Base material for RAL colors: aluminium

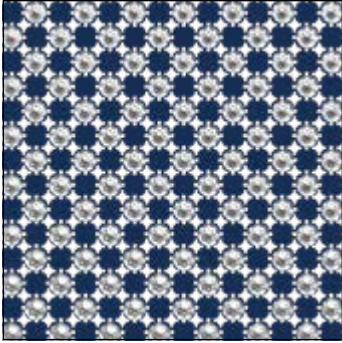
40 200 Crystal Mesh Colorée

SH	100
S	~500x200
E	1088 PP 21
M	1 SH 100%

40 201 Crystal Mesh Colorée

R	003-010
E	1088 PP 21
M	10 M 100%

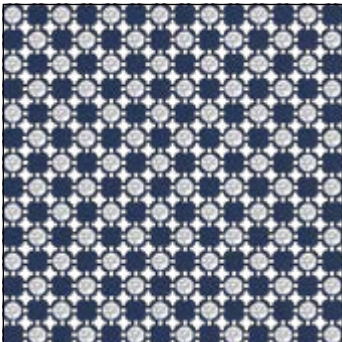
40 210 Crystal Mesh Colorée Mini

SH	100
S	~500x200
E	1028 PP13
M	1 SH 100%

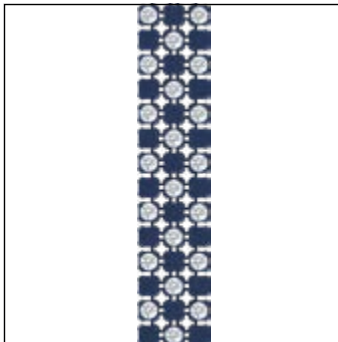
40 211 Crystal Mesh Colorée Mini

R	003-010
E	1028 PP13
M	10 M 100%

40 200/40 201
40 210/40 211

Size
40 200/40 201 Crystal Mesh Colorée PP 21
40 210/40 211 Crystal Mesh Colorée Mini PP 13

Crystal	40 200/40 201	40 210/40 211
Crystal F (001)	■	■
Colors		
Plain Colors		
Amethyst F (204)	■	■
Aquamarine F (202)	■	■
Black Diamond F (215)	■	■
Chrysolite F (238)	■	■
Citrus Green F (337)	■	■
Denim Blue F (266)	■	■
Emerald F (205)	■	■
Greige F (284)	■	■
Iris F (219)	■	■
Jet (280)	■	■
Light Amethyst F (212)	■	■
Light Colorado Topaz F (246)	■	■
Light Rose F (223)	■	■
Light Sapphire F (211)	■	■
Light Siam F (227)	■	■
Light Topaz F (226)	■	■
Light Turquoise F (263)	■	■
Majestic Green F (336)	■	■
Montana F (207)	■	■
Rose F (209)	■	■
Rose Peach F (262)	■	■
Sapphire F (206)	■	■
Scarlet F (276)	■	■
Siam F (208)	■	■
Silk F (391)	■	■
Tanzanite F (539)	■	■
Vintage Rose F (319)	■	■
Violet F (371)	■	■

40 200/40 201
40 210/40 211

Size
40 200/40 201 Crystal Mesh Colorée PP 21
40 210/40 211 Crystal Mesh Colorée Mini PP 13

Opal Colors	40 200/40 201	40 210/40 211
White Opal F (234)	■	■
Swarovski ReCreated™ Colors		
ReCreated™ Dark Jonquil F (1407)	■	■
ReCreated™ Dark Sapphire F (1404)	■	■
ReCreated™ Ice Blue F (1405)	■	■
ReCreated™ Light Smoked Topaz F (1402)	■	■
ReCreated™ Peridot F (1408)	■	■
ReCreated™ Smoked Topaz F (1403)	■	■
TCF™ Colors		
Dark Orange F (1202 TCF™)	■	■
Dark Rose F (1201 TCF™)	■	■
Crystal Effects		
Transparent Effects		
Crystal AB F (001 AB)	■	■
Crystal Golden Shadow F (001 GSHA)	■	■
Crystal Moonlight F (001 MOL)	■	■
Crystal Silver Night F (001 SINI)	■	■
Crystal Silver Shade F (001 SSHA)	■	■
Metallic Effects		
Crystal Aurum F (001 AUR)	■	■
Color Effects		
Metallic Effects		
Jet Hematite F (280 HEM)	■	■

AVAILABLE CASING COLORS

Crystal Mesh Colorée and Crystal Mesh Colorée Mini is available as standard with gold and silver-colored casings as well as the RAL colors Jet Black (RAL 9005), Night Blue (RAL 5022) and Light Ivory (RAL 1015).

All further RAL Classic and RAL Design Colors are possible as customized solution.



Crystal Caviar Mesh

ARTICLE EXPLANATION - SHEETS

40 500 Crystal Caviar Mesh

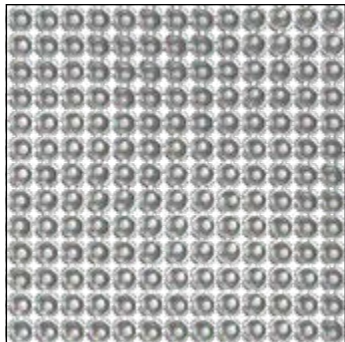

SH	100
S	~500x200
E	3495 MM2,5
M	1 SH 100%

Crystal Caviar Mesh

40 500	SH	S	E	M	100%
Article number	Sheet	Sheet size in mm	Elements Crystals and stone size used	Minimum order quantity in sheets (SH)	% of actual size

ORDERING EXAMPLE & PRODUCT VARIETY EXPLANATION

40 500	100	082	001	NOHF
Article number	Sheet	Color of casing	Color of crystals	Hotfix Technology
	100 Standard sheet (-500x200 mm)	012 Black ² 081 Gold ¹ 082 Silver ¹ R1018 Zinc Yellow ² R4010 Telemagenta ² R5002 Marine Blue ²	Please see the relevant product matrix for all available reference codes.	NOHF Without Hotfix glue / With Hotfix glue

¹ Base material for 081 Gold and 082 Silver-colored casing: brass

² Base material for RAL-colored casing: aluminum

ARTICLE EXPLANATION - ROWS

40 501 Crystal Caviar Mesh

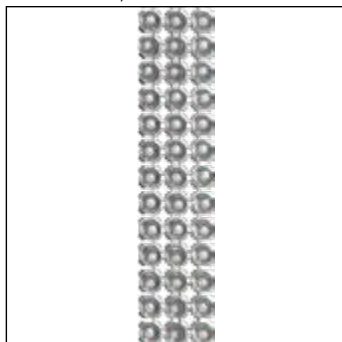

R 003-033

E 3495 MM2.5

M 10 M 100%

40 501	R	E	M	100%
Article number	Number of rows	Elements	Minimum order quantity in meters (M)	% of actual size
	This article is available from 3 to 33 rows.	Crystals and stone size used		

ORDERING EXAMPLE & PRODUCT VARIETY EXPLANATION

40 501	003	082	001	NOHF
Article number	3-digit code for number of rows	Color of casing	Color of crystals	Hotfix Technology
		012 Black ² 081 Gold ¹ 082 Silver ¹ R1018 Zinc Yellow ² R4010 Telemagenta ² R5002 Marine Blue ²	Please see the relevant product matrix for all available reference codes.	NOHF Without Hotfix glue / With Hotfix glue

¹ Base material for 081 Gold and 082 Silver-colored casing: brass

² Base material for RAL colors: aluminium

40 500 Crystal Caviar Mesh

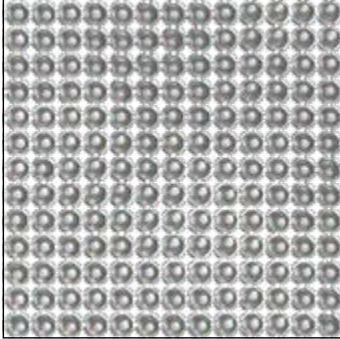

SH	100
S	~500x200
E	3495 MM2.5
M	1 SH 100%

40 501 Crystal Caviar Mesh

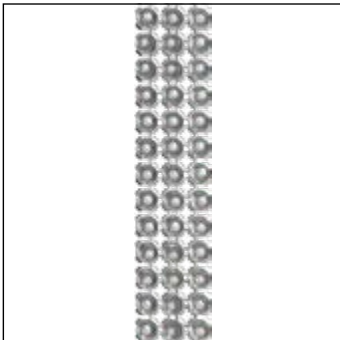

R	003-033
E	3495 MM2.5
M	10 M 100%

Crystal Caviar Mesh

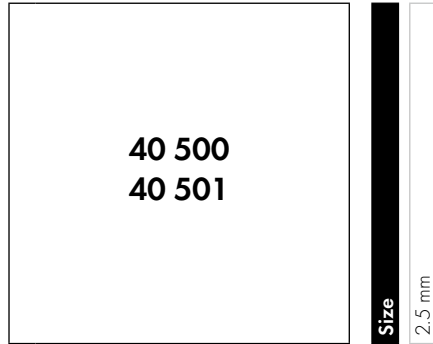

- Crystal**
- Crystal (001)
- Colors**
- Plain Colors**
- Jet (280)
- Silk (391)
- Crystal Effects**
- Transparent Effects**
- Crystal AB (001 AB)
- Crystal Moonlight (001 MOL)

AVAILABLE CASING COLORS

Crystal Caviar Mesh is available as standard with gold, silver and black-colored casings, as well as the RAL colors Zinc Yellow (R1018), Telemagenta (R4010) and Marine Blue (R5002).

All further RAL Classic and RAL Design Colors are possible as customized solution.

Please note that due to UV sensitivity, white is not offered.

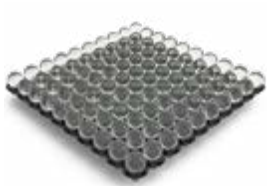

012 Black*



081 Gold*



082 Silver*

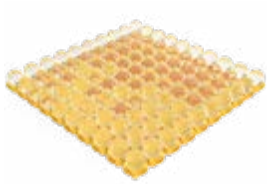

R1018 Zinc Yellow*

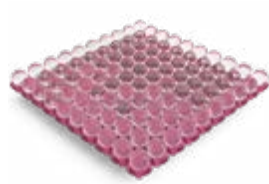

R4010 Telemagenta*

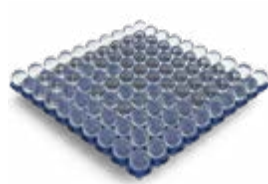

R5002 Marine Blue*

PRODUCT DETAILS

Article Variant	Packing Unit = Minimum Order Quantity	Number of Rows	Number of Crystals
40 000			
Sheet	~500x200 mm	170x66 rows	11,220
Row	Length: 10 m	2-33 rows	~3,400/row/10 m
40 400			
Sheet	~500x200 mm	170x66 rows	11,220
Row	Length: 10 m	2-33 rows	~3,400/row/10 m
40 600			
Sheet	~500x200 mm	286x110 rows	31,460
Row	Length: 10 m	3-33 rows	~5,720/row/10 m
40 800			
Sheet	~500x200 mm	121x45 rows	11,220
40 200 & 40 210			
Sheet	~500x200 mm	170x66 rows	5,610
Row	Length: 10 m	3-10 rows	~1,700/row/10 m
40 900 & 40 910			
Sheet	~500x200 mm	170x66 rows	5,610
Row	Length: 10 m	3-10 rows	~1,700/row/10 m
40 500			
Sheet	~500x200 mm	170x66 rows	11,220
Row	Length: 10 m	2-33 rows	~3,400/row/10 m

Article Casing Color	Weight for 1 sheet NOHF (g)*
40 000	
012	240
081, 082	395
088	365
40 400	
012	156
081, 082	311
RAL	156
40 600	
081, 082	255
40 800	
012	240
081, 082	390
40 200	
081, 082	310
RAL	160

Article Casing Color	Weight for 1 sheet NOHF (g)*
40 210	
081, 082	262
RAL	112
40 900	
081, 082	200
40 910	
081, 082	170
40 500	
012	340
081, 082	495
RAL	340

* Applying HF (Hotfix) to a sheet adds about 10 g to the overall sheet weight.

Cupchains

Cupchains, featuring either Round or Fancy Stones, are crafted with a metal chain base and offered in a wide variety of colors and sizes. Versatile in application, they can be soldered, plated, or sewn – by hand or by machine.

Cupchains Product Overview

ROUND CUPCHAIN & MULTIROW & MOTIFS

27 004



27 004 Multi-Row

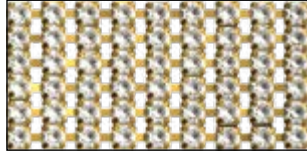

63 801

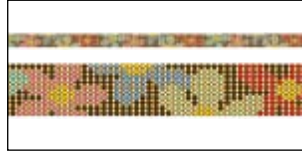

ROUND EXTENDED CUPCHAIN

27 104



SNAKE CHAIN

21 0D4



BAGUETTE CHAIN

21 004



ROUND SOLITAIRE CUPCHAIN

27 308

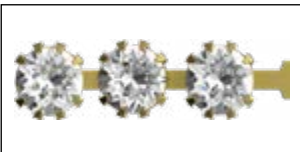

CATCH FREE CHAIN

27 001



BEZEL CHAIN

27 000



SQUARE CHAIN

28 002



Product Overview & Round Cupchain

Round Cupchain

ARTICLE EXPLANATION – BASE ITEM NUMBER

27 004 Round Cupchain

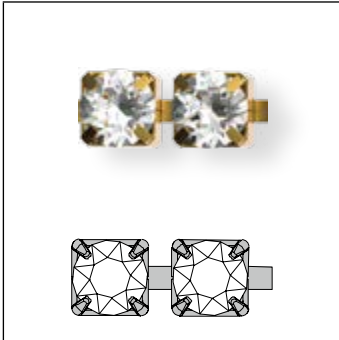

2	7	0	04
Product category	Stone code (type of stone used)	Setting code	Number of prongs in the setting (always 2-digit code)
2 Cupchains	7 Round	0 Basic 1 Extended	04

11

ORDERING EXAMPLE & PRODUCT VARIETY EXPLANATION

1	27 004	P24	00	C
Material type	Base item number	Stone size	Ring configuration	Back configuration
1 Brass		3-digit code from respective product matrix	00 None	C Closed
C1	Z	1028	F	001
Stone pattern	Plating	Base item art. no.	Foiling	Color of crystal
A1 Crystal with effect C1 Color K1 Crystal F2 2 alternate colors F3 3 alternate colors F4 4 alternate colors F5 5 alternate colors F6 6 alternate colors	Z No Plating H Rhodium 3 Gold Plating G Gun Metal Plating	1028 1088	F Foiled	

Not all configurations are available for all articles. Please refer to the respective product matrix for available combinations.

27 004 Round (Z)



E 1028/1088
M 20 M **250%¹**

Available Stone Sizes:

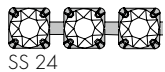
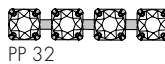
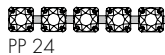
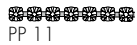

Round Cupchain

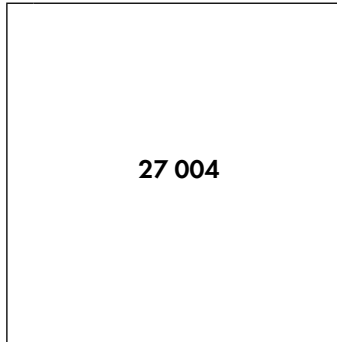

Size	PP 11	PP 14	PP 18	PP 24	PP 32	SS 24
------	-------	-------	-------	-------	-------	-------

Crystal

Crystal F (001)

Colors

Plain Colors

Amethyst F (204)

Aquamarine F (202)

Black Diamond F (215)

Chrysolite F (238)

Citrus Green F (337)

Denim Blue F (266)

Emerald F (205)

Greige F (284)

Iris F (219)

Jet (280)

Light Amethyst F (212)

Light Colorado Topaz F (246)

Light Rose F (223)

Light Sapphire F (211)

Light Siam F (227)

Light Topaz F (226)

Light Turquoise F (263)

Montana F (207)

Majestic Green F (336)

Rose F (209)

Rose Peach F (262)

Sapphire F (206)

Scarlet F (276)

Siam F (208)

Silk F (391)

Tanzanite F (539)















Vintage Rose F (319)

Violet F (371)

Crystal F (001)	■	■	■	■	■	■
Amethyst F (204)	■	■	■	■	■	■
Aquamarine F (202)	■	■	■	■	■	■
Black Diamond F (215)	■	■	■	■	■	■
Chrysolite F (238)	■	■	■	■	■	■
Citrus Green F (337)	■	■	■	■	■	■
Denim Blue F (266)	■	■	■	■	■	■
Emerald F (205)	■	■	■	■	■	■
Greige F (284)	■	■	■	■	■	■
Iris F (219)	■	■	■	■	■	■
Jet (280)	■	■	■	■	■	■
Light Amethyst F (212)	■	■	■	■	■	■
Light Colorado Topaz F (246)	■	■	■	■	■	■
Light Rose F (223)	■	■	■	■	■	■
Light Sapphire F (211)	■	■	■	■	■	■
Light Siam F (227)	■	■	■	■	■	■
Light Topaz F (226)	■	■	■	■	■	■
Light Turquoise F (263)	■	■	■	■	■	■
Montana F (207)	■	■	■	■	■	■
Majestic Green F (336)	■	■	■	■	■	■
Rose F (209)	■	■	■	■	■	■
Rose Peach F (262)	■	■	■	■	■	■
Sapphire F (206)	■	■	■	■	■	■
Scarlet F (276)	■	■	■	■	■	■
Siam F (208)	■	■	■	■	■	■
Silk F (391)	■	■	■	■	■	■
Tanzanite F (539)	■	■	■	■	■	■
Vintage Rose F (319)	■	■	■	■	■	■
Violet F (371)	■	■	■	■	■	■

The plating resistance of effects should be considered and can be verified using the respective product information sheet.

¹ The picture shows size PP 32

27 004		Size	PP 11	PP 14	PP 18	PP 24	PP 32	SS 24
Opal Colors								
 White Opal F (234)			■	■	■	■	■	■
Swarovski ReCreated™ Colors								
 ReCreated™ Dark Jonquil F (1407)			■	■	■	■	■	■
 ReCreated™ Dark Sapphire F (1404)			■	■	■	■	■	■
 ReCreated™ Ice Blue F (1405)			■	■	■	■	■	■
 ReCreated™ Light Smoked Topaz F (1402)			■	■	■	■	■	■
 ReCreated™ Peridot F (1408)			■	■	■	■	■	■
 ReCreated™ Smoked Topaz F (1403)			■	■	■	■	■	■
TCF™ Colors								
 Dark Orange F (1202 TCF™)			■	■	■	■	■	■
 Dark Rose F (1201 TCF™)			■	■	■	■	■	■
Crystal Effects								
Transparent Effects								
 Crystal Aurore Boreale F (001 AB)			■	■	■	■	■	■
 Crystal Golden Shadow F (001 GSHA)			■	■	■	■	■	■
 Crystal Moonlight F (001 MOL)			■	■	■	■	■	■
 Crystal Silver Night F (001 SINI)			■	■	■	■	■	■
 Crystal Silver Shade F (001 SSHA)			■	■	■	■	■	■

AVAILABLE PLATING COLORS

Standard cupchains are available in brass (unplated). The customer can use these cupchains for soldering, before plating them on their own.



Brass (Z) front

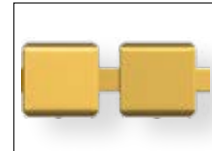

Brass (Z) back

The following color is available as customized solution:



Rhodium (H) front



Rhodium (H) back



Gold Plating (3) front

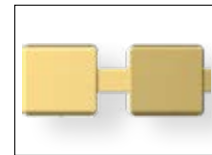

Gold Plating (3) back



Gun Metal plating (G) front



Gun Metal plating (G) back

Round Extended Cupchain

ARTICLE EXPLANATION - BASE ITEM NUMBER

27 104 Round Extended (Z)

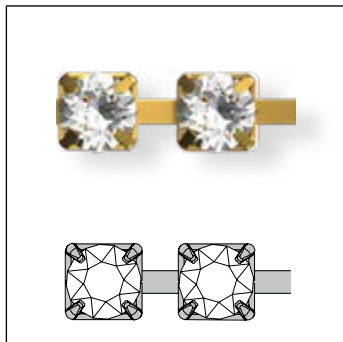

Round Extended Cupchain

2	7	1	04
Product category	Stone code (type of stone used)	Setting code	Number of prongs in the setting (always 2-digit code)
2 Cupchains	7 Round	0 Basic 1 Extended	04

ORDERING EXAMPLE & PRODUCT VARIETY EXPLANATION

1	27 104	P24	00	C
Material type	Base item number	Stone size	Ring configuration	Back configuration
1 Brass		3-digit code from respective product matrix	00 None	C Closed

C1	Z	1088	F	001
Stone pattern	Plating	Base item art. no.	Foiling	Color of crystals
A1 Crystal with effect C1 Color K1 Crystal F2 2 alternate colors F3 3 alternate colors F4 4 alternate colors F5 5 alternate colors F6 6 alternate colors	Z No Plating H Rhodium 3 Gold Plating G Gun Metal Plating	1088	F Foiled	

Not all configurations are available for all articles. Please refer to the respective product matrix for available combinations.

27 104 Round Extended (Z)



E 1028/1088
M 20 M **250%¹**

Available Stone Sizes:

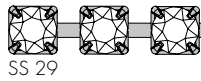
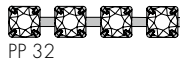
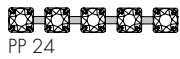
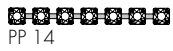

		Size			
		PP 14	PP 24	PP 32	SS 29
Crystal					
Crystal F (001)		■	■	■	■
Colors					
Plain Colors					
Amethyst F (204)		■	■	■	■
Aquamarine F (202)		■	■	■	■
Black Diamond F (215)		■	■	■	■
Chrysolite F (238)		■	■	■	■
Citrus Green F (337)		■	■	■	■
Denim Blue F (266)		■	■	■	■
Emerald F (205)		■	■	■	■
Greige F (284)		■	■	■	■
Iris F (219)		■	■	■	■
Jet (280)		■	■	■	■
Light Amethyst F (212)		■	■	■	■
Light Colorado Topaz F (246)		■	■	■	■
Light Rose F (223)		■	■	■	■
Light Sapphire F (211)		■	■	■	■
Light Siam F (227)		■	■	■	■
Light Topaz F (226)		■	■	■	■
Light Turquoise F (263)		■	■	■	■
Majestic Green F (336)		■	■	■	■
Montana F (207)		■	■	■	■
Rose F (209)		■	■	■	■
Rose Peach F (262)		■	■	■	■
Sapphire F (206)		■	■	■	■
Scarlet F (276)		■	■	■	■
Siam F (208)		■	■	■	■
Silk F (391)		■	■	■	■
Tanzanite F (539)		■	■	■	■
Vintage Rose F (319)		■	■	■	■
Violet F (371)		■	■	■	■
Opal Colors					
White Opal F (234)		■	■	■	■

The plating resistance of effects should be considered and can be verified using the respective product information sheet.

¹ The picture shows size PP 32

Round Extended Cupchain

27 104

Size	PP 14	PP 24	PP 32	SS 29
Swarovski ReCreated™ Colors				
	■	■	■	■
	■	■	■	■
	■	■	■	■
	■	■	■	■
	■	■	■	■
	■	■	■	■
TCF™ Colors				
	■	■	■	■
	■	■	■	■
Crystal Effects				
Transparent Effects				
	■	■	■	■
	■	■	■	■
				■
	■	■	■	■
	■	■	■	■
	■	■	■	■
Crystal Lacquer^{PRO} Effects*				
Crystal Lacquer^{PRO} Ignite Effects				
				■
				■
				■
				■
				■
				■

27 104

Size	PP 14	PP 24	PP 32	SS 29
Crystal Lacquer^{PRO} Ignite Effects				
				■
				■
				■
				■
				■
				■
				■
				■
				■
				■
				■
				■
				■
				■
				■
				■
				■
				■

* Application for Lacquer colors: it is recommended to use only laser welding or sewing.

AVAILABLE PLATING COLORS

Standard cupchains are available in brass (unplated).
The customer can use these cupchains for soldering,
before plating them on their own.



Brass (Z) front

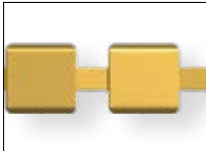

Brass (Z) back

The following color is available as customized solution:



Rhodium (H) front

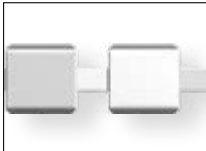

Rhodium (H) back



Gold Plating (3) front

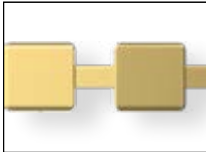

Gold Plating (3) back



Gun Metal plating (G)
front

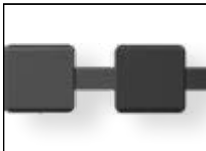

Gun Metal plating (G)
back

Snake Chain

ARTICLE EXPLANATION - BASE ITEM NUMBER

21 0D4 Snake Chain (Z)

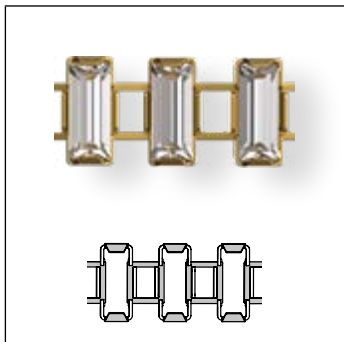

Snake Chain

2	1	0	D4
Product category	Stone code (type of stone used)	Setting code	Number of prongs in the setting (always 2-digit code)
2 Cupchains	1 Baguette	0 Basic	D4 Snake

ORDERING EXAMPLE & PRODUCT VARIETY EXPLANATION

1	21 0D4	7x3 mm	00	C
Material type	Base item number	Stone size	Ring configuration	Back configuration
1 Brass		3-digit code from respective product matrix	00 None	C Closed
C1	Z	4501	F	001
Stone pattern	Plating	Base item art. no.	Foiling	Color of crystals
A1 Crystal with effect C1 Color K1 Crystal	Z No Plating H Rhodium 3 Gold Plating G Gun Metal Plating	4501	F Foiled	

Not all configurations are available for all articles. Please refer to the respective product matrix for available combinations.

21 OD4 Snake Chain (Z)



E 4501
M 20 M **200%**

Available Stone Sizes:

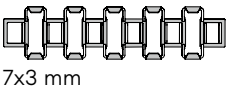

21 OD4

Size

7x3 mm

Crystal		Crystal F (001)	■
Colors			
Plain Colors			
●	Amethyst F (204)		■
●	Aquamarine F (202)		■
●	Black Diamond F (215)		■
●	Citrus Green F (337)		■
●	Emerald F (205)		■
●	Jet (280)		■
●	Light Amethyst F (212)		■
●	Light Colorado Topaz F (246)		■
●	Light Rose F (223)		■
●	Light Sapphire F (211)		■
●	Light Topaz F (226)		■
●	Light Turquoise F (263)		■
●	Majestic Green F (336)		■
●	Montana F (207)		■
●	Rose F (209)		■
●	Sapphire F (206)		■
●	Scarlet F (276)		■
●	Siam F (208)		■
●	Tanzanite F (539)		■
Opal Colors			
●	White Opal F (234)		■
Swarovski ReCreated™ Colors			
●	ReCreated™ Dark Jonquil F (1407)		■
●	ReCreated™ Light Smoked Topaz F (1402)		■
●	ReCreated™ Peridot F (1408)		■
●	ReCreated™ Smoked Topaz F (1403)		■
Crystal Effects			
Transparent Effects			
●	Crystal Aurore Boreale F (001 AB)		■
●	Crystal Golden Shadow F (001 GSHA)		■
●	Crystal Silver Night F (001 SINI)		■
●	Crystal Silver Shade F (001 SSHA)		■

AVAILABLE PLATING COLORS

Snake chains are available in brass (unplated).
The customer can use these cupchains for soldering, before plating them on their own.



Brass (Z) front

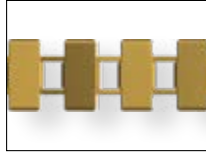

Brass (Z) back

The following color is available as customized solution:



Rhodium (H) front



Rhodium (H) back

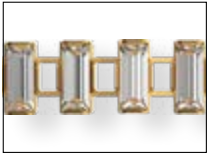

Gold Plating (3) front

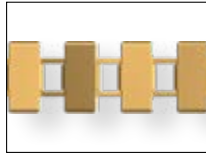

Gold Plating (3) back



Gun Metal plating (G)
front



Gun Metal plating (G)
back

Baguette Chain

ARTICLE EXPLANATION - BASE ITEM NUMBER

21 004 Baguette Chain (Z)

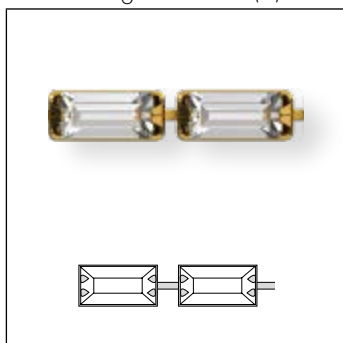

2	1	0	04
Product category	Stone code (type of stone used)	Setting code	Number of prongs in the setting (always 2-digit code)
2 Cupchains	1 Baguette	0 Basic	04

11

ORDERING EXAMPLE & PRODUCT VARIETY EXPLANATION

1	21 004	5x2.5 mm	00	C
Material type	Base item number	Stone size	Ring configuration	Back configuration
1 Brass		3-digit code from respective product matrix	00 None	C Closed
C1	Z	4501	F	001
Stone pattern	Plating	Base item art. no.	Foiling	Color of crystals
A1 Crystal with effect C1 Color K1 Crystal	Z No Plating H Rhodium 3 Gold Plating G Gun Metal Plating	4501	F Foiled	

21 004 Baguette Chain (Z)

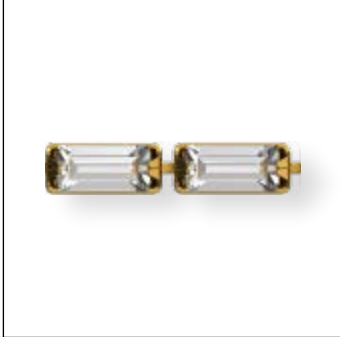

E 4501
M 20 M **250%**

Available Stone Sizes:

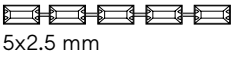

Baguette Chain

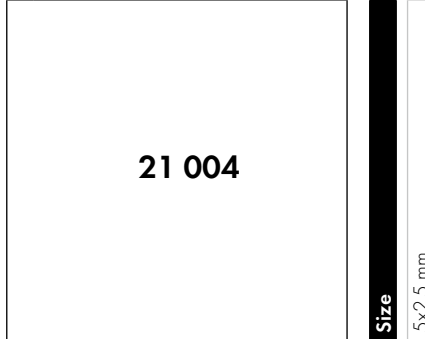

- Crystal**
- Crystal F (001)
- Colors**
- Plain Colors**
- Amethyst F (204)
- Aquamarine F (202)
- Black Diamond F (215)
- Citrus Green F (337)
- Emerald F (205)
- Jet (280)
- Light Amethyst F (212)
- Light Colorado Topaz F (246)
- Light Rose F (223)
- Light Sapphire F (211)
- Light Topaz F (226)
- Light Turquoise F (263)
- Majestic Green F (336)
- Montana F (207)
- Rose F (209)
- Sapphire F (206)
- Scarlet F (276)
- Siam F (208)
- Tanzanite F (539)
- Opal Colors**
- White Opal F (234)
- Swarovski ReCreated™ Colors**
- ReCreated™ Dark Jonquil F (1407)
- ReCreated™ Light Smoked Topaz F (1402)
- ReCreated™ Peridot F (1408)
- ReCreated™ Smoked Topaz F (1403)
- Crystal Effects**
- Transparent Effects**
- Crystal Aurore Boreale F (001 AB)
- Crystal Golden Shadow F (001 GSHA)
- Crystal Silver Night F (001 SINI)
- Crystal Silver Shade F (001 SSHA)

AVAILABLE PLATING COLORS

Baguette cupchains are available in brass (unplated).
The customer can use these cupchains for soldering,
before plating them on their own.

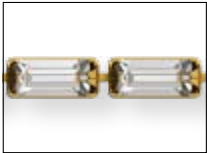

Brass (Z) front



Brass (Z) back

The following color is available as customized solution:



Rhodium (H) front



Rhodium (H) back

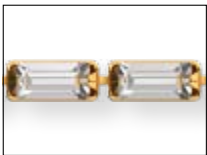

Gold Plating (3) front



Gold Plating (3) back

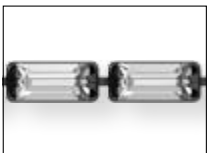

Gun Metal plating (G)
front



Gun Metal plating (G)
back

Round Solitaire Cupchain

ARTICLE EXPLANATION - BASE ITEM NUMBER

27 308 Round Solitaire Cupchain (Z)



Round Solitaire Cupchain

2	7	3	08
Product category	Stone code (type of stone used)	Setting code	Number of prongs in the setting (always 2-digit code)
2 Cupchains	7 Round	3 Solitaire	08

ORDERING EXAMPLE & PRODUCT VARIETY EXPLANATION

1	27 308	SS 29	00	C
Material type	Base item number	Stone size	Ring configuration	Back configuration
1 Brass		3-digit code from respective product matrix	00 None	C Closed
C1	Z	1088	F	001
Stone pattern	Plating	Base item art. no.	Foiling	Color of crystals
A1 Crystal with effect C1 Color K1 Crystal	Z No Plating H Rhodium 3 Gold Plating G Gun Metal Plating	1088	F Foiled	

27 308 Round Solitaire Cupchain (Z)

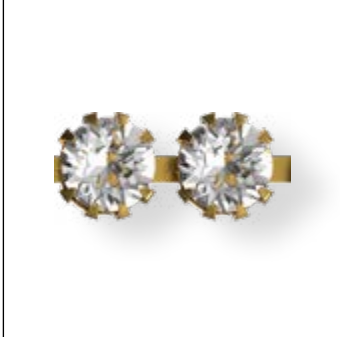

E 1088
M 20 M **200%**

Available Stone Sizes:

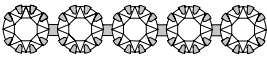

SS 29



Crystal

Crystal F (001)

Colors

Plain Colors

Amethyst F (204)

Aquamarine F (202)

Black Diamond F (215)

Chrysolite F (238)

Citrus Green F (337)

Denim Blue F (266)

Emerald F (205)

Greige F (284)

Iris F (219)

Jet (280)

Light Amethyst F (212)

Light Colorado Topaz F (246)

Light Rose F (223)

Light Sapphire F (211)

Light Siam F (227)

Light Topaz F (226)

Light Turquoise F (263)

Majestic Green F (336)

Montana F (207)

Rose F (209)

Rose Peach F (262)

Sapphire F (206)

Scarlet F (276)

Siam F (208)

Silk F (391)

Tanzanite F (539)



















Vintage Rose F (319)

Violet F (371)

Opal Colors

White Opal F (234)



- Swarovski ReCreated™ Colors**
-  ReCreated™ Dark Jonquil F (1407)
 -  ReCreated™ Dark Sapphire F (1404)
 -  ReCreated™ Ice Blue F (1405)
 -  ReCreated™ Light Smoked Topaz F (1402)
 -  ReCreated™ Peridot F (1408)
 -  ReCreated™ Smoked Topaz F (1403)
- TCF™ Colors**
-  Dark Orange F (1202 TCF™)
 -  Dark Rose F (1201 TCF™)
- Crystal Effects**
- Transparent Effects**
-  Crystal Aurore Boreale F (001 AB)
 -  Crystal Golden Shadow F (001 GSHA)
 -  Crystal Moonlight F (001 MOL)
 -  Crystal Silver Night F (001 SINI)
 -  Crystal Silver Shade F (001 SSHA)
- Crystal Lacquer^{PRO} Effects***
- Crystal Lacquer^{PRO} Ignite Effects**
-  Crystal Flamingo Ignite (001 L162I)
 -  Crystal Linen Ignite (001 L164I)
 -  Crystal Maroon Ignite (001 L160I)
 -  Crystal Orange Ignite (001 L159I)
 -  Crystal Purple Ignite (001 L161I)
 -  Crystal Sky Ignite (001 L163I)

- Crystal Lacquer^{PRO} Ignite Effects**
-  Crystal Agave Ignite (001 L165I)
 -  Crystal Dahlia Ignite (001 L177I)
 -  Crystal Dark Grey Ignite (001 L111I)
 -  Crystal Denim Ignite (001 L166I)
 -  Crystal Flamingo Ignite (001 L162I)
 -  Crystal Linen Ignite (001 L164I)
 -  Crystal Mango Ignite (001 L152I)
 -  Crystal Maroon Ignite (001 L160I)
 -  Crystal Orange Ignite (001 L159I)
 -  Crystal Orchid Ignite (001 L171I)
 -  Crystal Pine Green Ignite (001 L170I)
 -  Crystal Poppy Red Ignite (001 L179I)
 -  Crystal Purple Ignite (001 L161I)
 -  Crystal Sky Ignite (001 L163I)
 -  Crystal Soft Mint Ignite (001 L168I)
 -  Crystal Soft Rose Ignite (001 L167I)
 -  Crystal Soft Yellow Ignite (001 L169I)
 -  Crystal Teal Ignite (001 L178I)

* Application for Lacquer colors: it is recommended to use only laser welding or sewing.

AVAILABLE PLATING COLORS

Round Solitaire Cupchains are available in brass (unplated). The customer can use these cupchains for soldering, before plating them on their own.

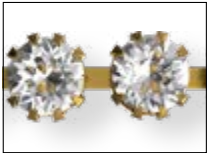

Brass (Z) front

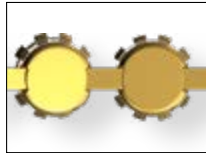

Brass (Z) back

The following color is available as customized solution:

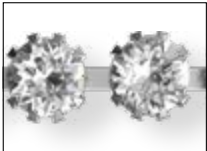

Rhodium (H) front

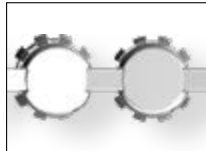

Rhodium (H) back

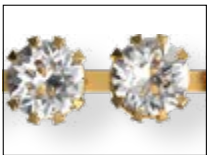

Gold Plating (3) front

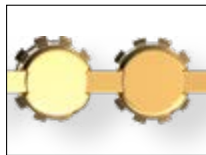

Gold Plating (3) back

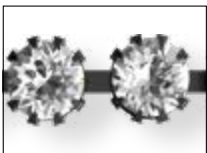

Gun Metal plating (G)
front

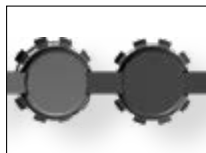

Gun Metal plating (G)
back

Catch Free Chain

ARTICLE EXPLANATION - BASE ITEM NUMBER

27 001 Catch Free Chain (R)



Catch Free Chain

2	7	0	01
Product category	Stone code (type of stone used)	Setting code	Number of prongs in the setting (always 2-digit code)
2 Cupchains	7 Round	0 Basic	01 Catch-Free

ORDERING EXAMPLE & PRODUCT VARIETY EXPLANATION

1	27 001	PP 18	00	C
Material type	Base item number	Stone size	Ring configuration	Back configuration
1 Brass		3-digit code from respective product matrix	00 None	C Closed
C1	Z	1088	F	001
Stone pattern	Plating	Base item art. no.	Foiling	Color of crystals
A1 Crystal with effect C1 Color K1 Crystal	Z No Plating H Rhodium 3 Gold Plating G Gun Metal Plating	1088	F Foiled	

27 001 Catch Free Chain (R)



E 1088
M 20 M **250%**

Available Stone Sizes:



PP 18





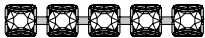











PP 24



PP 32

27 001	Size		
	PP 18	PP 24	PP 32
Crystal			
Crystal F (001)	■	■	■
Colors			
Plain Colors			
Amethyst F (204)	■	■	■
Aquamarine F (202)	■	■	■
Black Diamond F (215)	■	■	■
Chrysolite F (238)	■	■	■
Citrus Green F (337)	■	■	■
Denim Blue F (266)	■	■	■
Emerald F (205)	■	■	■
Greige F (284)	■	■	■
Iris F (219)	■	■	■
Jet (280)	■	■	■
Light Amethyst F (212)	■	■	■
Light Colorado Topaz F (246)	■	■	■
Light Rose F (223)	■	■	■
Light Sapphire F (211)	■	■	■
Light Siam F (227)	■	■	■
Light Topaz F (226)	■	■	■
Light Turquoise F (263)	■	■	■
Majestic Green F (336)	■	■	■
Montana F (207)	■	■	■
Rose F (209)	■	■	■
Rose Peach F (262)	■	■	■
Sapphire F (206)	■	■	■
Scarlet F (276)	■	■	■
Siam F (208)	■	■	■
Silk F (391)	■	■	■
Tanzanite F (539)	■	■	■
Vintage Rose F (319)	■	■	■
Violet F (371)	■	■	■

* The picture shows size PP 32

27 001		Size	PP 18	PP 24	PP 32
Opal Colors					
 White Opal F (234)			■	■	■
Swarovski ReCreated™ Colors					
 ReCreated™ Dark Jonquil F (1407)			■	■	■
 ReCreated™ Dark Sapphire F (1404)			■	■	■
 ReCreated™ Ice Blue F (1405)			■	■	■
 ReCreated™ Light Smoked Topaz F (1402)			■	■	■
 ReCreated™ Peridot F (1408)			■	■	■
 ReCreated™ Smoked Topaz F (1403)			■	■	■
TCF™ Colors					
 Dark Orange F (1202 TCF™)			■	■	■
 Dark Rose F (1201 TCF™)			■	■	■
Crystal Effects					
Transparent Effects					
 Crystal Aurore Boreale F (001 AB)			■	■	■
 Crystal Golden Shadow F (001 GSHA)			■	■	■
 Crystal Moonlight F (001 MOL)			■	■	■
 Crystal Silver Night F (001 SINI)			■	■	■
 Crystal Silver Shade F (001 SSHA)			■	■	■

AVAILABLE PLATING COLORS

Catch-free Cupchains are available in brass (unplated). The customer can use these cupchains for soldering, before plating them on their own.

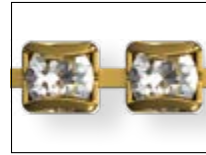

Brass (Z) front

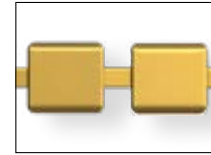

Brass (Z) back

The following color is available as customized solution:



Rhodium (H) front

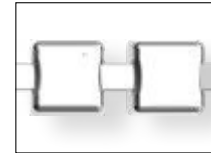

Rhodium (H) back

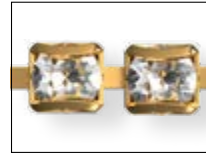

Gold Plating (3) front

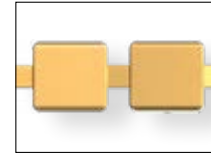

Gold Plating (3) back



Gun Metal plating (G) front



Gun Metal plating (G) back

Bezel Chain

ARTICLE EXPLANATION - BASE ITEM NUMBER

27 000 Bezel Chain



2	7	0	00
Product category	Stone code (type of stone used)	Setting code	Number of prongs in the setting (always 2-digit code)
2 Cupchains	7 Round	0 Basic 1 Extended	00

11

ORDERING EXAMPLE & PRODUCT VARIETY EXPLANATION

1	27 000	P24	00	C
Material type	Base item number	Stone size	Ring configuration	Back configuration
1 Brass		3-digit code from respective product matrix	00 None	C Closed
C1	Z	1088	F	001
Stone pattern	Plating	Base item art. no.	Foiling	Color of crystal
A1 Crystal with effect C1 Color K1 Crystal F2 2 alternate colors F3 3 alternate colors F4 4 alternate colors F5 5 alternate colors F6 6 alternate colors	Z No Plating H Rhodium	1088	F Foiled	

27 000 Bezel Chain (Z)

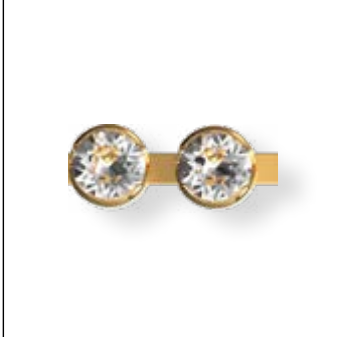

E 1088
M 20 M **250%¹**

Available Stone Sizes:

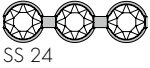
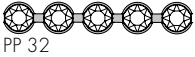
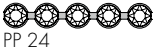

Bezel Chain

Size	PP 24	PP 32	SS 24
Crystal			
Crystal F (001)	■	■	■
Colors			
Plain Colors			
Amethyst F (204)	■	■	■
Aquamarine F (202)	■	■	■
Black Diamond F (215)	■	■	■
Chrysolite F (238)	■	■	■
Citrus Green F (337)	■	■	■
Denim Blue F (266)	■	■	■
Emerald F (205)	■	■	■
Greige F (284)	■	■	■
Iris F (219)	■	■	■
Jet (280)	■	■	■
Light Amethyst F (212)	■	■	■
Light Colorado Topaz F (246)	■	■	■
Light Rose F (223)	■	■	■
Light Sapphire F (211)	■	■	■
Light Siam F (227)	■	■	■
Light Topaz F (226)	■	■	■
Light Turquoise F (263)	■	■	■
Majestic Green F (336)	■	■	■
Montana F (207)	■	■	■
Rose F (209)	■	■	■
Rose Peach F (262)	■	■	■
Sapphire F (206)	■	■	■
Scarlet F (276)	■	■	■
Siam F (208)	■	■	■
Silk F (391)	■	■	■
Tanzanite F (539)	■	■	■
Vintage Rose F (319)	■	■	■
Violet F (371)	■	■	■

The plating resistance of effects should be considered and can be verified using the respective product information sheet.

¹ The picture shows size PP 32

27 000	Size	PP 24	PP 32	SS 24
Opal Colors				
White Opal F (234)		■	■	■
Swarovski ReCreated™ Colors				
ReCreated™ Dark Jonquil F (1407)		■	■	■
ReCreated™ Dark Sapphire F (1404)		■	■	■
ReCreated™ Ice Blue F (1405)		■	■	■
ReCreated™ Light Smoked Topaz F (1402)		■	■	■
ReCreated™ Peridot F (1408)		■	■	■
ReCreated™ Smoked Topaz F (1403)		■	■	■
TCF™ Colors				
Dark Orange F (1202 TCF™)		■	■	■
Dark Rose F (1201 TCF™)		■	■	■
Crystal Effects				
Transparent Effects				
Crystal Aurore Boreale F (001 AB)		■	■	■
Crystal Golden Shadow F (001 GSHA)		■	■	■
Crystal Moonlight F (001 MOL)		■	■	■
Crystal Silver Night F (001 SINI)		■	■	■
Crystal Silver Shade F (001 SSHA)		■	■	■

AVAILABLE PLATING COLORS

Bezel Chains are available in brass (unplated). The customer can use these cupchains for soldering, before plating them on their own.



Brass (Z) front

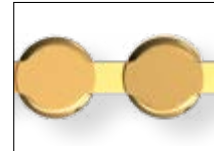

Brass (Z) back

The following color is available as customized solution:

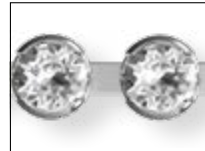

Rhodium (H) front

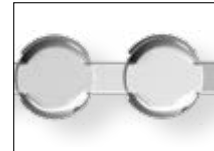

Rhodium (H) back



Gold Plating (3) front



Gold Plating (3) back



Gun Metal plating (G) front



Gun Metal plating (G) back

Square Chain

ARTICLE EXPLANATION - BASE ITEM NUMBER

28 002 Square Chain (Z)

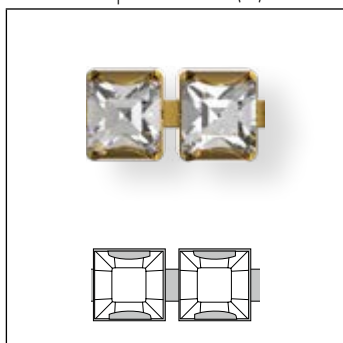

Square Chain

2	8	0	02
Product category	Stone code (type of stone used)	Setting code	Number of prongs in the setting (always 2-digit code)
2 Cupchains	8 Square	0 Basic	02

ORDERING EXAMPLE & PRODUCT VARIETY EXPLANATION

1	28 002	4 mm	00	C
Material type	Base item number	Stone size	Ring configuration	Back configuration
1 Brass		3-digit code from respective product matrix	00 None	C Closed
C1	Z	4428	F	001
Stone pattern	Plating	Base item art. no.	Foiling	Color of crystals
A1 Crystal with effect C1 Color K1 Crystal	Z No Plating H Rhodium 3 Gold Plating G Gun Metal Plating	4428	F Foiled	

28 002 Square Chain (Z)



E 4428
M 20 M **250%**

Available Stone Sizes:



4 mm

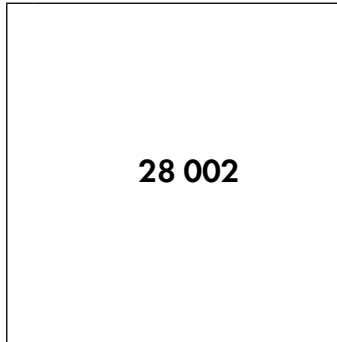

Crystal

Crystal F (001)

Colors

Plain Colors

Amethyst F (204)

Aquamarine F (202)

Black Diamond F (215)

Citrus Green F (337)

Emerald F (205)

Greige F (284)

Iris F (219)

Jet (280)

Light Amethyst F (212)

Light Colorado Topaz F (246)

Light Rose F (223)

Light Sapphire F (211)

Light Siam F (227)

Light Topaz F (226)

Light Turquoise F (263)

Majestic Green F (336)

Montana F (207)

Rose F (209)

Rose Peach F (262)

Sapphire F (206)

Scarlet F (276)

Siam F (208)

Silk F (391)

Tanzanite F (539)



- Swarovski ReCreated™ Colors**
- ReCreated™ Dark Jonquil F (1407)
 - ReCreated™ Dark Sapphire F (1404)
 - ReCreated™ Ice Blue F (1405)
 - ReCreated™ Light Smoked Topaz F (1402)
 - ReCreated™ Peridot F (1408)
 - ReCreated™ Smoked Topaz F (1403)
- TCF™ Colors**
- Dark Orange F (1202 TCF™)
 - Dark Rose F (1201 TCF™)
- Crystal Effects**
- Transparent Effects**
- Crystal Aurore Boreale F (001 AB)
 - Crystal Golden Shadow F (001 GSHA)
 - Crystal Moonlight F (001 MOL)
 - Crystal Silver Night F (001 SINI)
 - Crystal Silver Shade F (001 SSHA)

AVAILABLE PLATING COLORS

Square Cupchains are available in brass (unplated). The customer can use these cupchains for soldering, before plating them on their own.



Brass (Z) front

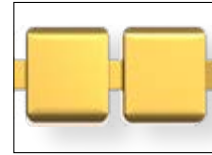

Brass (Z) back

The following color is available as customized solution:



Rhodium (H) front

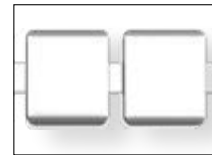

Rhodium (H) back

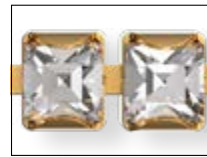

Gold Plating (3) front

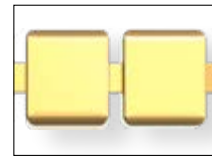

Gold Plating (3) back



Gun Metal plating (G) front



Gun Metal plating (G) back

Multi-Row Cupchain

ARTICLE EXPLANATION - BASE ITEM NUMBER

27 004 Multi-Row Cupchain

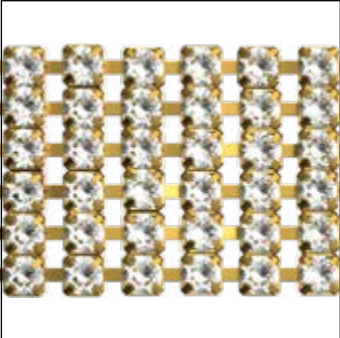

2	7	0	04	R
Product category	Stone code (type of stone used)	Setting code	Number of prongs in the setting (always 2-digit code)	Number of rows
2 Cupchains	7 Round	0 Basic	04	This article is available from 2 to 10 rows.

ORDERING EXAMPLE & PRODUCT VARIETY EXPLANATION

Single Color Variant

1	27 004	P24	03	C
Material type	Base item number	Stone size	Number of rows	Back configuration
1 Brass		3-digit code from respective product matrix	02-10	C Closed

C1	Z	1028	F	001
Stone pattern	Plating	Base item art. no.	Foiling	Color of crystals
A1 Crystal with effect C1 Color K1 Crystal	Z No Plating	1028 1088	F Foiled	

Motif Variant

1	63 808	P24	03	C
Material type	Base item number	Stone size	Number of rows	Back configuration
1 Brass	Generated by SC Office (Unique)	3-digit code from respective product matrix	02-10	C Closed

M9	Z	1028	F	001 280 215
Number of colors used within motif (2 to 9 colors)	Plating	Base item art. no.	Foiling	List of colors of crystals
M2-M9	Z No Plating	1028 1088	F Foiled	

27 004 Multi-Row Cupchain

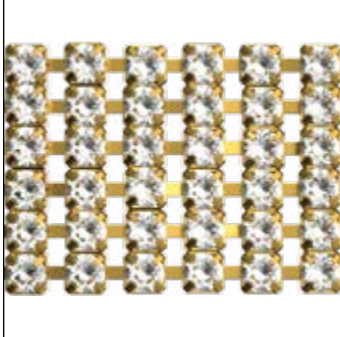

R	02-10
E	1028/1088
M	5 M 300%¹

Available Stone Sizes:



PP 11

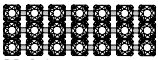

PP 14

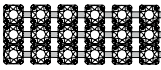

PP 18

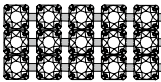

PP 24

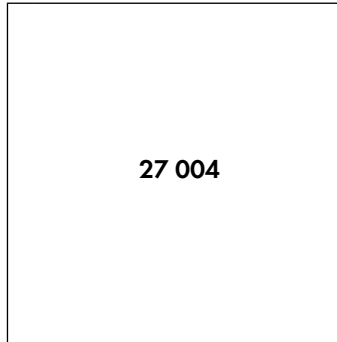

Size	PP 11	PP 14	PP 18	PP 24
-------------	-------	-------	-------	-------

Crystal

Crystal F (001)

Colors

Plain Colors

Amethyst F (204)

Aquamarine F (202)

Black Diamond F (215)

Chrysolite F (238)

Citrus Green F (337)

Denim Blue F (266)

Emerald F (205)

Greige F (284)

Iris F (219)

Jet (280)

Light Amethyst F (212)

Light Colorado Topaz F (246)

Light Rose F (223)

Light Sapphire F (211)

Light Siam F (227)

Light Topaz F (226)

Light Turquoise F (263)

Majestic Green F (336)

Montana F (207)

Rose F (209)

Rose Peach F (262)

Sapphire F (206)

Scarlet F (276)

Siam F (208)















Silk F (391)

Tanzanite F (539)

Vintage Rose F (319)

Violet F (371)

¹ The picture shows size PP 11

27 004		Size	PP 11	PP 14	PP 18	PP 24
Opal Colors						
	White Opal F (234)		■	■	■	■
Swarovski ReCreated™ Colors						
	ReCreated™ Dark Jonquil F (1407)		■	■	■	■
	ReCreated™ Dark Sapphire F (1404)		■	■	■	■
	ReCreated™ Ice Blue F (1405)		■	■	■	■
	ReCreated™ Light Smoked Topaz F (1402)		■	■	■	■
	ReCreated™ Peridot F (1408)		■	■	■	■
	ReCreated™ Smoked Topaz F (1403)		■	■	■	■
TCF™ Colors						
	Dark Orange F (1202 TCF™)		■	■	■	■
	Dark Rose F (1201 TCF™)		■	■	■	■
Crystal Effects						
Transparent Effects						
	Crystal Aurore Boreale F (001 AB)		■	■	■	■
	Crystal Golden Shadow F (001 GSHA)		■	■	■	■
	Crystal Moonlight F (001 MOL)		■	■	■	■
	Crystal Silver Night F (001 SINI)		■	■	■	■
	Crystal Silver Shade F (001 SSHA)		■	■	■	■

AVAILABLE PLATING COLORS

Standard cupchains are available in brass (unplated). The customer can use these cupchains for soldering, before plating them on their own.

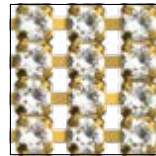

Brass (Z) front

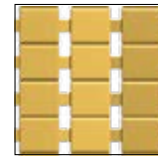

Brass (Z) back

SPECIAL MOTIF SERVICE

A special motif is a design created by the customer that differs to the Multirow Cupchains Standard Collection and Inspirational Motifs. This service opens up an abundance of customization possibilities and enables you to profit from Swarovski's long-standing experience and design expertise. A range of customization options for existing motifs is available (see "Customization Possibilities"

below). You can also submit design sketches that meet your special needs, such as a brand image or an image for a particular sales campaign. This will then be made up according to your specifications using Computer Aided Design, which means that adjustments can be made easily according to your needs.

Customization Possibilities

- Change of size or color of an existing motif
- Creation of a new motif (ex. Logos, brand names, patterns...)
- Up to nine colors are possible per Multirow Cupchains Motif
- Each motif can have a maximum length of 20 cm. The motif will then repeat within the Multirow Cupchains roll

Ordering Process

Send your request with the drawing you wish to order to your nearest Swarovski sales office.

Make sure you include all measurements for the desired motif, as well as the size of the desired cupchains and the numbers of rows you wish to have (2 to 10 maximum).

You will then receive a quotation including your article number, minimum order quantity, price, and the line drawing of your special motif in PDF format.

Please contact your Swarovski sales office again if any changes are required. Your special motif will be produced and delivered following your confirmation.

Please Note

Please always submit the drawing of your desired motif to represent it in the actual size you require. A small sketch, when enlarged to the desired size, will have blurred lines that will make it difficult to correctly reproduce. Pictures or drawings representing 100% size of the design or very good quality scans in JPG, BMP, or DXF format will ensure that we have clear data to work with. These can also be sent via email. If sending a sewing pattern, please include the whole pattern and not just sections. When the sketch is submitted as a copy by email, please include a scale

legend (e.g. copy/scan with a ruler next to the drawing). This will ensure that the desired size of the motif can be identified.

Special productions are generally offered to all our customers if these are deemed to be feasible and comply with our General Terms and Conditions. Please note ordering of a design does not grant exclusive production of this design to the customer.

INSPIRATIONAL MOTIFS

63 800

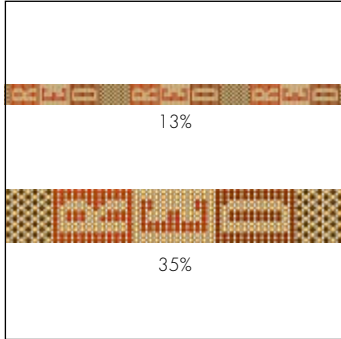

C BRASS-001/227/208/280/276
E PP11/PP11/PP11/PP11/PP11
S ~122x20 MM (48x10 ELEMENTS)
M 5.02 METRES

63 801

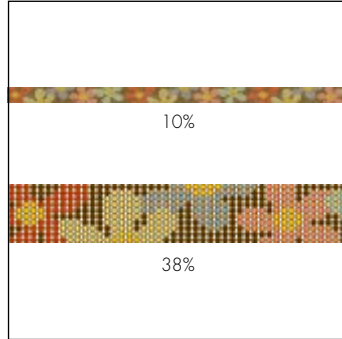

C BRASS-280/202/276/209/214/206/226
E PP11/PP11/PP11/PP11/PP11/PP11/PP11
S ~163x20 MM (64x10 ELEMENTS)
M 5.06 METRES

63 802

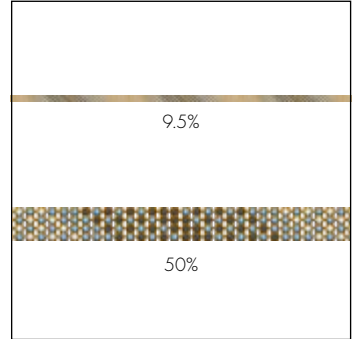

C BRASS-211/206/001/207
E PP14/PP14/PP14/PP14
S ~158x9 MM (54x4 ELEMENTS)
M 5.06 METRES

63 803

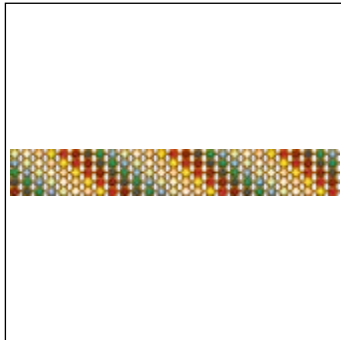

C BRASS-246/226/276/208/207/205/206/214/001
E PP14/PP14/PP14/PP14/PP14/PP14/PP14/PP14/PP14
S ~26x11 MM (9x5 ELEMENTS)
M 5.01 METRES **55%**

63 804

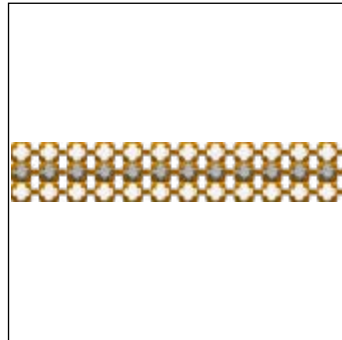

C BRASS-001/001SINI
E PP18/PP18
S ~15x8 MM (4x3 ELEMENTS)
M 5.01 METRES **100%**

63 805

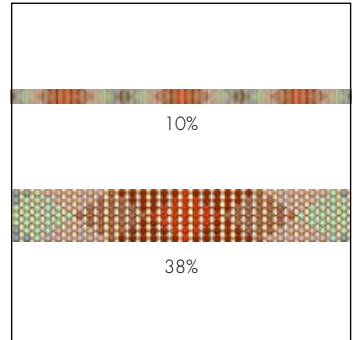

C BRASS-202/204/206/539/208/207/227
E PP18/PP18/PP18/PP18/PP18/PP18/PP18/PP18
S ~154x18 MM (42x7 ELEMENTS)
M 5.09 METRES

63 806

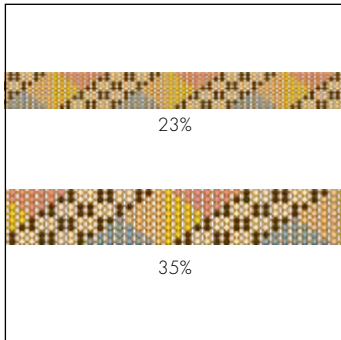

C BRASS-280/001/246/226/209/206
E PP18/PP18/PP18/PP18/PP18/PP18
S ~66x21 MM (18x8 ELEMENTS)
M 5.02 METRES

63 807

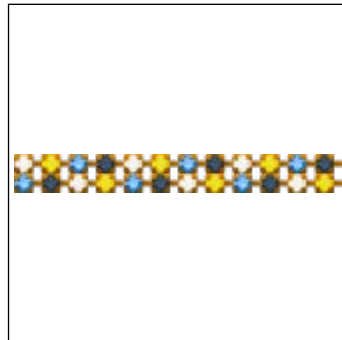

C BRASS-226/207/206/001
E PP24/PP24/PP24/PP24
S ~18x6 MM (4x2 ELEMENTS)
M 5.02 METRES **80%**

63 808

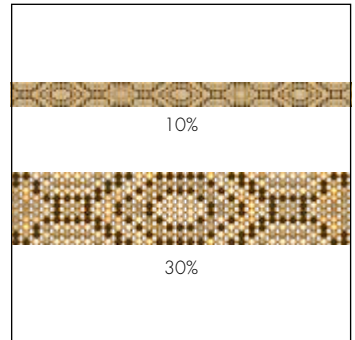

C BRASS-280/001/001SSHA/234/001SINI/215/246/001GSHA/391
E PP24/PP24/PP24/PP24/PP24/PP24/PP24/PP24/PP24
S ~158x32 MM (35x10 ELEMENTS)
M 5.5 METRES

Multi-Row Cupchain



Crystal Rivets & Rose Pins

Crystal Rivets and Rose Pins are forward-integrated products designed for mechanical application onto fabrics, leather, and a variety of other materials. Renowned for their flexibility and versatility, they are bestsellers across textile and accessory segments due to their wide range of creative and practical applications.

Crystal Rivets

ARTICLE EXPLANATION

53 001 Rivets



E	1088 SS 29
M	500 PCS 150%

53 001	E	M	150%
Article number	Elements Crystals and stone size used	Minimum order quantity in pieces (PCS)	% of actual size

Crystal Rivets

ORDERING EXAMPLE & PRODUCT VARIETY EXPLANATION

53 001	082	001
Article number	Color of casing 081 Gold 082 Silver 086 Gun Metal 088 Stainless Steel	Color of crystals Please see the respective product matrix for all available reference code.

Please note that the Back Parts for Rivets must be ordered separately. Please see the respective product matrix for all available Back Parts on page 412.

RIVETS

53 001 Rivets



E 1088 SS 29
M 500 PCS 150%

53 005 Rivets



E 1088 SS 34
M 500 PCS 150%

53 006 Rivets



E 1088 SS 39
M 300 PCS 150%

53 001
53 005
53 006

Size	SS 29	SS 34	SS 39
Crystal			
Crystal F (001)	■	■	■
Colors			
Plain Colors			
Amethyst F (204)	■	■	■
Aquamarine F (202)	■	■	■
Black Diamond F (215)	■	■	■
Chrysolite F (238)	■	■	■
Citrus Green F (337)	■	■	■
Denim Blue F (266)	■	■	■
Emerald F (205)	■	■	■
Greige F (284)	■	■	■
Iris F (219)	■	■	■
Jet (280)	■	■	■
Light Amethyst F (212)	■	■	■
Light Colorado Topaz F (246)	■	■	■
Light Rose F (223)	■	■	■
Light Sapphire F (211)	■	■	■
Light Siam F (227)	■	■	■
Light Topaz F (226)	■	■	■
Light Turquoise F (263)	■	■	■
Majestic Green F (336)	■	■	■
Montana F (207)	■	■	■
Rose F (209)	■	■	■
Rose Peach F (262)	■	■	■
Sapphire F (206)	■	■	■
Scarlet F (276)	■	■	■
Siam F (208)	■	■	■
Silk F (391)	■	■	■
Tanzanite F (539)	■	■	■
Vintage Rose F (319)	■	■	■
Violet F (371)	■	■	■
Opal Colors			
White Opal F (234)	■	■	■

53 001 53 005 53 006	Size	SS 29	SS 34	SS 39
---	-------------	-------	-------	-------

Swarovski ReCreated™ Colors				
	ReCreated™ Dark Jonquil F (1407)			
	ReCreated™ Dark Sapphire F (1404)			
	ReCreated™ Ice Blue F (1405)			
	ReCreated™ Light Smoked Topaz F (1402)			
	ReCreated™ Peridot F (1408)			
	ReCreated™ Smoked Topaz F (1403)			
TCF™ Colors				
	Dark Orange F (1202 TCF™)			
	Dark Rose F (1201 TCF™)			
Crystal Effects				
Transparent Effects				
	Crystal Aurore Boreale F (001 AB)			
	Crystal Golden Shadow F (001 GSHA)			
	Crystal Ignite (001 IGNIT)			
	Crystal Moonlight F (001 MOL)			
	Crystal Silver Night F (001 SINI)			
	Crystal Silver Shade F (001 SSHA)			
Metallic Effects				
	Crystal Aurum F (001 AUR)			
Crystal Lacquer ^{PRO} Effects				
Crystal Lacquer ^{PRO} Ignite Effects				
	Crystal Agave Ignite (001 L1651)			
	Crystal Dahlia Ignite (001 L1771)			
	Crystal Dark Grey Ignite (001 L1111)			
	Crystal Denim Ignite (001 L1661)			
	Crystal Flamingo Ignite (001 L1621)			
	Crystal Linen Ignite (001 L1641)			
	Crystal Mango Ignite (001 L1521)			
	Crystal Maroon Ignite (001 L1601)			

53 001 53 005 53 006	Size	SS 29	SS 34	SS 39
---	-------------	-------	-------	-------

	Crystal Orange Ignite (001 L1591)			
	Crystal Orchid Ignite (001 L1711)			
	Crystal Pine Green Ignite (001 L1701)			
	Crystal Poppy Red Ignite (001 L1791)			
	Crystal Purple Ignite (001 L1611)			
	Crystal Sky Ignite (001 L1631)			
	Crystal Soft Mint Ignite (001 L1681)			
	Crystal Soft Rose Ignite (001 L1671)			
	Crystal Soft Yellow Ignite (001 L1691)			
	Crystal Teal Ignite (001 L1781)			
Crystal Electric Lacquer ^{PRO} Ignite Effects				
	Crystal Electric Blue Ignite (001 L1341)			
	Crystal Electric Green Ignite (001 L1351)			
	Crystal Electric Orange Ignite (001 L1361)			
	Crystal Electric Pink Ignite (001 L1371)			
	Crystal Electric Violet Ignite (001 L1481)			
	Crystal Electric White Ignite (001 L1391)			
	Crystal Electric Yellow Ignite (001 L1381)			
Color Effects				
Metallic Effects				
	Jet Hematite F (280 HEM)			

Available Casing Colors

Rivets are available in gold, silver and gunmetal plated casing, as well as Stainless Steel.



081 Gold



082 Silver



086 Gun Metal



088 Stainless Steel

Tools for Fly Press

Required Application Tools	Upper Die	Vacuum Adapter ¹	Spare Part for Upper Die (insert) ²	Lower Die for application with Back Part:	Lower Die for application with Back Part:	Lower Die for application without Back Part for Rivet Casing	Lower Die for application without Back Part for Rivet Casing Color
						088 Stainless Steel	081 Gold 082 Silver 086 Gun Metal
		Art. 9040/023		Art. 9070/010	Art. 9070/012	Art. 9070/011	Art. 9040/015

53 001



Art. 9070/005 M8	Art. 9040/023	Art. 9070/008
Art. 9070/009 M6	-	

53 005



Art. 9040/064 M8	Art. 9040/023	Art. 9040/062
Art. 9040/063 M6	-	

53 006



Art. 9040/067 M8	Art. 9040/023	Art. 9040/065
Art. 9040/066 M6	-	

¹ When using Swarovski's fly press, tools with M8 thread and the corresponding vacuum adapter are necessary.

² The Spare Part (plastic insert) is incorporated into the Upper Die as standard. It should be changed when it becomes worn.

Back Parts for Rivets

53 007



M 1,000 PCS **100%**

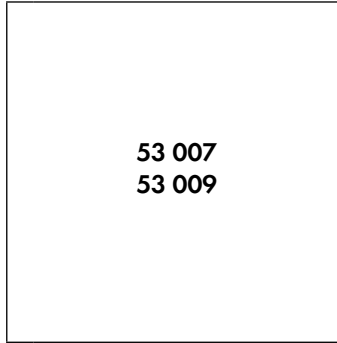

Rivets (Color of Casing)

53 001 (081)	■
53 001 (088)	■
53 005 (081)	■
53 005 (088)	■
53 006 (081)	■
53 006 (088)	■

53 009



M 1,000 PCS **100%**

Crystal Rivets & Rose Pins

Ordering Example & Product Variety Explanation

53 007	081
Article number	Color of casing
	081 Gold
	088 Stainless Steel

Rose Pins

ARTICLE EXPLANATION

53 301 Rose Pins

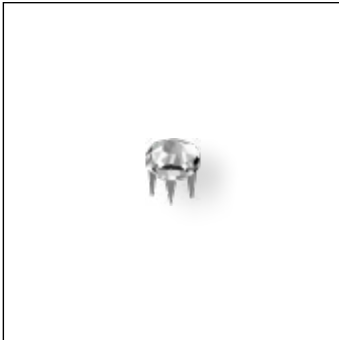

E 2038 SS 10

M 1,440 PCS **250%**

53 301	E	M	250%
Article number	Elements Crystals and stone size used	Minimum order quantity in pieces (PCS)	% of actual size

ORDERING EXAMPLE & PRODUCT VARIETY EXPLANATION

53 301	088	001
Article number	Color of casing 088 Stainless Steel	Color of crystals Please see the respective product matrix for all available reference code.

53 301 Rose Pins

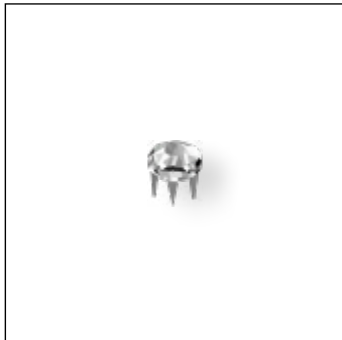

E 2038 SS 10
M 1,440 PCS **250%**

53 303 Rose Pins



E 2078 SS 20
M 720 PCS **250%**

53 302 Rose Pins



E 2078 SS 16
M 1,440 PCS **250%**

53 304 Rose Pins



E 2078 SS 34
M 288 PCS **250%**

Rose Pins

53 301 53 302 53 303 53 304	Size	SS 10	SS 16	SS 20	SS 34
--	-------------	-------	-------	-------	-------

Crystal					
Crystal Hifix Transparent (001 HFT)					
Crystal A HF (001)					
Colors					
Plain Colors					
Amethyst A HF (204)					
Aquamarine A HF (202)					
Black Diamond A HF (215)					
Blue Zircon A HF (229)					
Blush Rose A HF (257)					
Burgundy A HF (515)					
Capri Blue A HF (243)					
Chrysolite A HF (238)					
Citrus Green A HF (337)					
Cobalt A HF (369)					
Dark Indigo A HF (288)					
Denim Blue A HF (266)					
Emerald A HF (205)					
Erinte A HF (360)					
Fern Green A HF (291)					
Fuchsia A HF (502)					
Graphite A HF (253)					
Greige A HF (284)					
Indian Pink A HF (289)					
Indian Siam A HF (327)					
Indicolite A HF (379)					
Iris A HF (219)					
Jet HFT (280)					
Jet A HF (280)					
Jonquil A HF (213)					
Light Amethyst A HF (212)					
Light Colorado Topaz A HF (246)					
Light Peach A HF (362)					
Light Rose A HF (223)					
Light Sapphire A HF (211)					
Light Siam A HF (227)					

53 301 53 302 53 303 53 304	Size	SS 10	SS 16	SS 20	SS 34
--	-------------	-------	-------	-------	-------

Light Silk A HF (261)					
Light Topaz A HF (226)					
Light Turquoise A HF (263)					
Majestic Blue A HF (296)					
Majestic Green A HF (336)					
Montana A HF (207)					
Padparadscha A HF (542)					
Provence Lavender A HF (283)					
Purple Velvet A HF (277)					
Rose A HF (209)					
Rose Peach A HF (262)					
Ruby A HF (501)					
Sapphire A HF (206)					
Scarlet A HF (276)					
Siam A HF (208)					
Silk A HF (391)					
Tanzanite A HF (539)					
Topaz A HF (203)					
Vintage Rose A HF (319)					
Opal Colors					
White Opal A HF (234)					
Swarovski ReCreated™ Colors					
ReCreated™ Dark Jonquil F (1407)					
ReCreated™ Dark Sapphire F (1404)					
ReCreated™ Ice Blue F (1405)					
ReCreated™ Light Smoked Topaz A HF (1402)					
ReCreated™ Peridot A HF (1408)					
ReCreated™ Smoked Topaz A HF (1403)					
TCF™ Colors					
Dark Orange A HF (1202 TCF™)					
Dark Rose A HF (1201 TCF™)					
Crystal Effects					
Transparent Effects					
Crystal Aurore Boreale A HF (001 AB)					
Crystal Bermuda Blue A HF (001 BB)					
Crystal Blue Shade A HF (001 BLSH)					

	Size	SS 10	SS 16	SS 20	SS 34
53 301					
53 302					
53 303					
53 304					
Crystal Golden Shadow A HF (001 GSHA)					
Crystal Heliotrope A HF (001 HEL)					
Crystal Moonlight A HF (001 MOL)					
Crystal Paradise Shine A HF (001 PARSH)					
Crystal Shimmer A HF (001 SHIM)					
Crystal Silver Night A HF (001 SINI)					
Crystal Silver Shade A HF (001 SSHA)					
Crystal Transmission HFT (001 TRA)					
Crystal Volcano A HF (001 VOL)					
Metallic Effects					
Crystal Aurum A HF (001 AUR)					
Crystal Light Chrome A HF (001 LTCH)					
Crystal Metallic Sunshine A HF (001 METSH)					
Crystal Rose Gold A HF (001 ROGL)					
Crystal Lacquer^{PRO} Effects					
Crystal Lacquer^{PRO} Ignite Effects					
Crystal Flamingo Ignite HFT (001 L1621)					
Crystal Linen Ignite HFT (001 L1641)					
Crystal Maroon Ignite HFT (001 L1601)					
Crystal Orange Ignite HFT (001 L1591)					
Crystal Purple Ignite HFT (001 L1611)					
Crystal Sky Ignite HFT (001 L1631)					
Crystal Lacquer^{PRO} Ignite Effects					
Crystal Agave Ignite HFT (001 L1651)					
Crystal Dahlia Ignite HFT (001 L1771)					
Crystal Dark Grey Ignite HFT (001 L1111)					
Crystal Denim Ignite HFT (001 L1661)					
Crystal Flamingo Ignite HFT (001 L1621)					
Crystal Linen Ignite HFT (001 L1641)					
Crystal Mango Ignite HFT (001 L1521)					
Crystal Maroon Ignite HFT (001 L1601)					
Crystal Orange Ignite HFT (001 L1591)					
Crystal Orchid Ignite HFT (001 L1711)					
Crystal Pine Green Ignite HFT (001 L1701)					
Crystal Poppy Red Ignite HFT (001 L1791)					
Crystal Purple Ignite HFT (001 L1611)					

	Size	SS 10	SS 16	SS 20	SS 34
53 301					
53 302					
53 303					
53 304					
Crystal Sky Ignite HFT (001 L1631)					
Crystal Soft Mint Ignite HFT (001 L1681)					
Crystal Soft Rose Ignite HFT (001 L1671)					
Crystal Soft Yellow Ignite HFT (001 L1691)					
Crystal Teal Ignite HFT (001 L1781)					
Crystal Electric Lacquer^{PRO} Ignite Effects					
Crystal Electric Blue Ignite HFT (001 L1341)					
Crystal Electric Green Ignite HFT (001 L1351)					
Crystal Electric Orange Ignite HFT (001 L1361)					
Crystal Electric Pink Ignite HFT (001 L1371)					
Crystal Electric Violet Ignite HFT (001 L1481)					
Crystal Electric White Ignite HFT (001 L1391)					
Crystal Electric Yellow Ignite HFT (001 L1381)					
Color Effects					
Transparent Effects					
Black Diamond Shimmer A HF (215 SHIM)					
Blue Zircon Shimmer A HF (229 SHIM)					
Capri Blue Nightfall A HF (243 NIFA)					
Emerald Nightfall A HF (205 NIFA)					
Fuchsia Shimmer A HF (502 SHIM)					
Graphite Nightfall A HF (253 NIFA)					
Jet AB A HF (280 AB)					
Jonquil AB A HF (213 AB)					
Light Rose AB A HF (223 AB)					
Light Rose Shimmer A HF (223 SHIM)					
Light Sapphire Shimmer A HF (211 SHIM)					
Light Siam AB A HF (227 AB)					
Light Siam Shimmer A HF (227 SHIM)					
ReCreated™ Peridot Shimmer A HF (1408 SHIM)					
Sapphire AB A HF (206 AB)					
Siam Nightfall A HF (208 NIFA)					
Silk Shimmer A HF (391 SHIM)					
Tanzanite Shimmer A HF (539 SHIM)					
Topaz Shimmer A HF (203 SHIM)					
Metallic Effects					
Jet Hematite A HF (280 HEM)					

Tools for Fly Press

Required Application Tools	Upper Die	Spare Part ¹	Lower Die	Centering Aid ²
				

53 301



Art. 9040/090 M6	Art. 9040/094	Art. 9070/013	Art. 9070/017
---------------------	---------------	---------------	---------------

53 302



Art. 9040/091 M6	Art. 9040/095	Art. 9070/014	-
---------------------	---------------	---------------	---

53 303



Art. 9040/092 M6	Art. 9040/096	Art. 9070/014	-
---------------------	---------------	---------------	---

53 304



Art. 9040/093 M6	Art. 9040/097	Art. 9070/016	-
---------------------	---------------	---------------	---

Rose Pins can be easily applied using a fly press, a semi- or fully-automated attaching machine. Please note the material thickness when selecting Rose Pins.

	ART.	SIZE	MATERIAL THICKNESS*
ROSE PINS	53 301	SS 10	1 – 2 mm
	53 302	SS 16	0.7 – 2 mm
	53 303	SS 20	0.7 – 2 mm
	53 304	SS 34	0.7 – 2 mm

¹ The Spare Part is integrated into the Upper Die as standard. It should be changed when it becomes worn.

² The centering aid (art. 9070/017) for Rose Pin 53 301 allows the product to be easily positioned in the upper die.

* This can vary according to the softness and production of the carrier material.

Application Tools

Swarovski provides a variety of optimized application methods—from gluing and Hotfix to sewing and mechanical techniques—ensuring seamless and efficient production. The product range includes an extensive selection of adhesives, mechanical tools, and other application tools, allowing crystals to be applied simply, quickly, and securely.

Crystal Glues CG 500 (A+B) & CG 610 (A+B)

CG 500 (A+B) and CG 610 (A+B) are two-component epoxy resin glues especially developed for gluing both foiled and unfoiled crystals. The highest quality can be ensured by following the entire application process.

Please consult our Application Manual for detailed information.

AVAILABLE PACKAGING VERSIONS

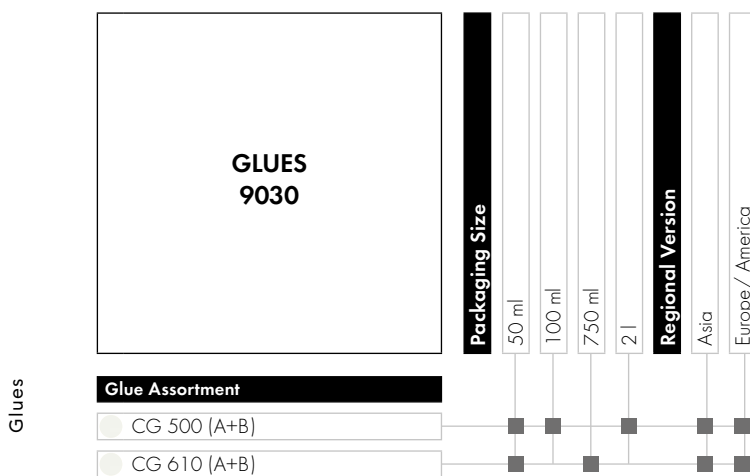

ORDERING EXAMPLE & PRODUCT VARIETY EXPLANATION

9030	CG 500 (A+B)	100 ml	Europe/America
Article number	Crystal glue type	Packaging size	Regional version
9030	CG 500 (A+B) CG 610 (A+B)	50 ml 100 ml 750 ml 2 l	Asia Europe/America

Field of Application

	Color	Viscosity	Crystal	Glass	Ceramics	Stone	Aluminum	Brass	Silver	Steel	PC	PS	PVC/ABS	PMMA	Paper	Cork	Wood	Textiles ¹	Small Chatons (Xero)
CG 500 (A+B)	translucent	med	+	+	+	+	+	+	+	+	+	+	+	+	○	○	○	-	-
CG 610 (A+B)	translucent	low	+	+	+	+	+	+	+	+	+	+	○	○	○	○	○	-	+

Please note: packaging contains the total amount of glue, e.g.
 CG 500 (A+B) 50 ml Cartridge = 25 ml component A and 25 ml component B (mixture ratio by volume 100:100 (A:B))
 CG 610 (A+B) 50 ml Cartridge = 33.33 ml component A and 16.67 ml component B (mixture ratio by volume 100:50 (A:B)).

¹ For permanent (wash-resistant) applications, Hotfix application is recommended.

Gluing Tools

Article number	Description	Details
9030/000	Test Pen	For the inspection of the surface tension.
9030/126	Mixing nozzle for CG 500 (A+B) and CG 610 (A+B)	The mixing nozzle is suitable for the 50 ml cartridge of both Crystal Glue types and comes in a packaging size of 10 pieces.
9040/022	Vacuum pump with silicone hose, can be adapted to a pick-up system	Dispensing tip for adapting the vacuum pump has to be ordered separately, suppliers are listed in the Application Manual, in the Gluing chapter.



Mechanical Tools

MACHINES & TOOLS FOR MECHANICAL APPLICATION

Article number	Description	Details
9040/019 & 9040/017	<p>9040/019 Fly press with mounting board</p> <p>9040/017 Fly press without mounting board</p>	<p>The fly press can be used to mechanically apply Swarovski crystals.</p> <p>To be used with mechanical tools. Inner thread of M6 spindle used to fix mechanical tools or vacuum adapters.</p>
9040/022	Vacuum pump for fly press	<p>Vacuum pump with silicone hose to hold Rose Pins, and Rivets in place in the fly press.</p>
9040/023	Vacuum adapter with M8 inner thread	<p>M6 outer thread to be fixed to fly press and M8 inner thread to hold the Upper Die. For Rivets.</p>

TOOLS FOR RIVETS

Required Application Tools	Upper Die	Vacuum Adapter ¹	Spare Part for Upper Die (Insert) ²	Lower Die for application with Back Part:	Lower Die for application with Back Part:	Lower Die for application without Back Part for Rivet with casing color 088 Stainless Steel	Lower Die for application without Back Part for Rivet with casing color 081 Gold 082 Silver 086 Gun Metal	
								
	Art. 9040/023		53 007	53 009	Art. 9070/010	Art. 9070/012	Art. 9070/011	Art. 9040/015

53 001



Art. 9070/005 M8	Art. 9040/023	Art. 9070/008
Art. 9070/009 M6 ³	-	

53 005



Art. 9040/064 M8	Art. 9040/023	Art. 9040/062
Art. 9040/063 M6	-	

53 006



Art. 9040/067 M8	Art. 9040/023	Art. 9040/065
Art. 9040/066 M6	-	

Mechanical Tools

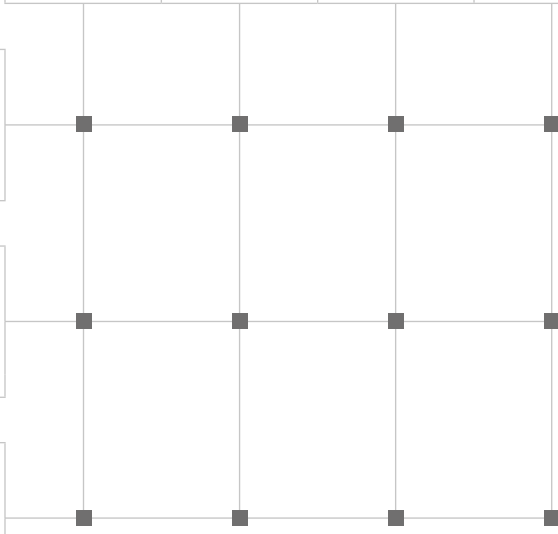

¹ When using the Swarovski fly press, tools with M8 thread and the corresponding vacuum adapter are necessary.

² The Spare Part (plastic insert) is incorporated into the Upper Die as standard. It should be changed when it becomes worn.

³ Tools with no adapter (e.g. 9040/014 M6) can be screwed directly in a fly press. The fly press therefore must have the option of a vacuum directly through the shaft.

TOOLS FOR ROSE PINS

53 301 Rose Pin (SS 10)

	Required Application Tools	Upper Die	Spare Part ¹	Lower Die	Centering Aid ²
		Art. 9040/090 M6	Art. 9040/094	Art. 9070/013	Art. 9070/017

53 302 Rose Pin (SS 16)

	Required Application Tools	Upper Die	Spare Part ¹	Lower Die
		Art. 9040/091 M6	Art. 9040/095	Art. 9070/014

53 303 Rose Pin (SS 20)

	Required Application Tools	Upper Die	Spare Part ¹	Lower Die
		Art. 9040/092 M6	Art. 9040/096	Art. 9070/014

53 304 Rose Pin (SS 34)

	Required Application Tools	Upper Die	Spare Part ¹	Lower Die
		Art. 9040/093 M6	Art. 9040/097	Art. 9070/016

¹ The Spare Part (plastic insert) is integrated into the Upper Die as standard. It should be changed when it becomes worn.

² The Centering Aid (art. 9070/017) for Rose Pin 53 301 allows the product to be easily positioned in the Upper Die.

Hotfix Application Tools

TOOLS FOR HOTFIX APPLICATION

Hotfix Application Tools & Sewing, embroidery, and hand application Tools





Article number	Description	Details
9010/002 	Silicone ironing pad (foam) 134x100 cm, 54x40 in	Compensating pad for applying Transfers of different sizes of crystals
9010/003 	Teflon® foil 100x50 cm, 40x20 in	Teflon® foil to protect heated surfaces from any glue residue
9010/005 	Silicone pad 50x50x0.2 cm, 20x20x0.08 in	For application of Crystal Diamond Transfers
9010/006 	Silicone board 50x25x0.1 cm, 20x10x0.05 in	For hand setting and designing Transfers
9010/007 	Temperature measuring strips	To check temperature in a heat press at various points on the heating surface. It ensures that heat is distributed evenly across the surface.

Table of Sizes

Table of Sizes

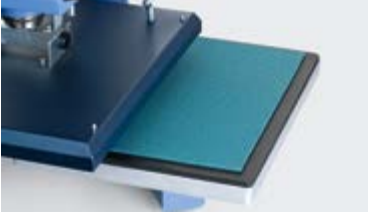
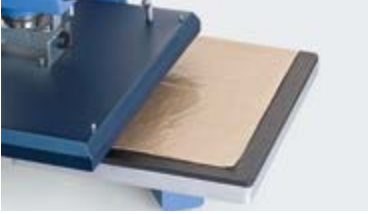
•	PP 0 0.70–0.80 mm	●	PP 21 (SS 10) 2.70–2.80 mm	●	SS 26 5.61–5.78 mm	●	SS 45 9.85–10.19 mm
•	PP 1 (SS 000) 0.80–0.90 mm	●	PP 22 (SS 10) 2.80–2.90 mm	●	SS 27 5.78–5.96 mm	●	
•	PP 2 (SS 00) 0.90–1.00 mm	●	PP 23 (SS 11) 2.90–3.00 mm	●	SS 28 5.96–6.14 mm	●	SS 46 10.19–10.54 mm
•	PP 3 (SS 0) 1.00–1.10 mm	●	PP 24 (SS 12) 3.00–3.20 mm	●	SS 29 6.14–6.32 mm	●	
•	PP 4 (SS 1) 1.10–1.20 mm	●	PP 25 (SS 13) 3.20–3.30 mm	●	SS 30 6.32–6.50 mm	●	SS 47 10.54–10.91 mm
•	PP 5 (SS 2) 1.20–1.30 mm	●	PP 26 (SS 13) 3.30–3.40 mm	●	SS 31 6.50–6.68 mm	●	
•	PP 6 (SS 2) 1.30–1.35 mm	●	PP 27 (SS 14) 3.40–3.50 mm	●	SS 32 6.68–6.87 mm	●	SS 48 10.91–11.30 mm
•	PP 7 (SS 3) 1.35–1.40 mm	●	PP 28 (SS 14) 3.50–3.60 mm	●	SS 33 6.87–7.07 mm	●	
•	PP 8 (SS 3) 1.40–1.50 mm	●	PP 29 (SS 15) 3.60–3.70 mm	●	SS 34 7.07–7.27 mm	●	SS 49 11.30–11.72 mm
•	PP 9 (SS 4) 1.50–1.60 mm	●	PP 30 (SS 15) 3.70–3.80 mm	●	SS 35 7.27–7.48 mm	●	
•	PP 10 (SS 4) 1.60–1.70 mm	●	PP 31 (SS 16) 3.80–4.00 mm	●	SS 36 7.48–7.70 mm	●	SS 50 11.72–11.97 mm
•	PP 11 (SS 5) 1.70–1.80 mm	●	PP 32 (SS 17) 4.00–4.10 mm	●	SS 37 7.70–7.93 mm	●	
•	PP 12 (SS 5) 1.80–1.90 mm	●	PP 33 (SS 17) 4.10–4.20 mm	●	SS 38 7.93–8.16 mm	●	SS 55 12.97–13.22 mm
•	PP 13 (SS 6) 1.90–2.00 mm	●	SS 18 4.20–4.40 mm	●	SS 39 8.16–8.41 mm	●	
•	PP 14 (SS 6) 2.00–2.10 mm	●	SS 19 4.40–4.60 mm	●	SS 40 8.41–8.67 mm	●	SS 60 14.22–14.47 mm
•	PP 15 (SS 7) 2.10–2.20 mm	●	SS 20 4.60–4.80 mm	●	SS 41 8.67–8.95 mm	●	
•	PP 16 (SS 7) 2.20–2.30 mm	●	SS 21 4.80–4.90 mm	●	SS 42 8.95–9.23 mm	●	SS 65 15.47–15.72 mm
•	PP 17 (SS 8) 2.30–2.40 mm	●	SS 22 4.90–5.10 mm	●	SS 43 9.23–9.53 mm	●	
•	PP 18 (SS 8) 2.40–2.50 mm	●	SS 23 5.10–5.27 mm	●	SS 44 9.53–9.85 mm	●	SS 70 16.72–16.97 mm
•	PP 19 (SS 9) 2.50–2.60 mm	●	SS 24 5.27–5.44 mm	●		●	
•	PP 20 (SS 9) 2.60–2.70 mm	●	SS 25 5.44–5.61 mm	●		●	SS 75 17.97–18.22 mm



Notes





VALID FROM JANUARY 2026

Sys.No. 5762295

Content is subject to change without notice. Errors and misprints excepted.
Please note, the actual products may deviate from the pictures in color and effect.
D. Swarovski Distribution GmbH, Swarovskistrasse 30, 6112 Wattens, Austria

© 2026 D. Swarovski Distribution GmbH. All rights reserved. Partial or total
publication, transmission, copy, or other duplication of texts, graphics, pictures etc.
which are to be found in this publication is forbidden without special consent by
D. Swarovski Distribution GmbH.
Swarovski® is a registered trademark of Swarovski AG.

Please visit our website for contact information: [swarovski.com/s-professionals](https://www.swarovski.com/s-professionals)

Printed by ATHESIA, Innsbruck, Austria