



Crystal Transfers

Swarovski Crystal Transfers are captivating motifs made from Swarovski Flat Backs Hotfix, utilizing XIRIUS and XILION Roses, Creation Stones, as well as Cabochons or Metallics in varying designs.











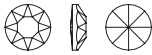





















Able to incorporate up to 18 different elements or colors in the one motif, with a seamless and effortless application process for myriad textiles, sparkling creativity has never appeared so easy. Swarovski Crystal Transfers prove to be an excellent choice for Hotfix application on a wide range of apparel and accessories. Moreover, the self-adhesive Crystal IT Transfers can be affixed to hard, non-washable surfaces.

Our range of Inspirational Motifs is designed to offer a glimpse into the vast array of Transfer possibilities, and may be ordered as they are or modified to the customer's desire, with our Design Experts able to assist in realizing any unique customization requirement. The assortment is a balanced mix of large and small motifs in all price categories, as well as a good representation of all the different elements that can be used in Crystal Transfer motifs.



Overview of Flat Backs Hotfix for Crystal Transfers

Detailed information per Flat Back Hotfix may be found in chapter "Flat Backs Hotfix" pages 84 to 113.

1 2 3		1098 A HF PP 24 (SS 12), PP 31 (SS 16) SS 20	1 2		2303 M HF 8x5, 14x9 mm	1 2		2738 M HF 10x5, 12x6 mm
		2000 A HF SS 3			2304 M HF 10x2.8, 14x3.9 mm			2739 M HF 5.8x5.3, 7x6.5 mm
		2038 A HF SS 5, 6, 8, 10			2400 M HF 2.2, 3, 4, 6 mm			2740 M HF 8.3x8.3, 10x10 mm
		2038/1 A HF SS 10			2471 M HF 5, 7, 10 mm			2754 M HF 4, 6 mm
		2078 A HF SS 12, 16, 20, 30, 34, 40, 48			2472 M HF 5, 7, 10 mm			2770 M HF 6x3.5 mm
		2078/1 A HF SS 16, 20			2510 M HF 3.7x1.9, 5x2.5 mm			2771 M HF 6.4x4.2, 8.6x5.6, 12.9x8.3 mm
		2080/4 HF SS 6, 10, 16, 20, 34			2555 M HF 8x2.6, 12x4 mm			2772 M HF 6.5x2.1, 8.6x2.8, 12.9x4.2 mm
		2200 HF 4x2, 8x4 mm			2602 M HF 3.7x2.5, 8x5.5, 14x10 mm			2773 M HF 5x3, 6.6x3.9, 9.9x5.9 mm
		2201 M HF 4x1.8, 8x3.5, 14x6 mm			2603 M HF 4x3, 8x6, 14x10 mm			2774 M HF 6.3x4.2, 8.3x5.6, 12.5x8.4 mm
		2205 M HF 7.5, 10, 14 mm			2711 M HF 3.3, 6 mm			2775 M HF 5x4.2, 6.7x5.6, 10x8.4 mm
		2300 M HF 8x4.8 mm			2715 M HF 3, 4 mm			2776 M HF 8.2x4.2, 11x5.6, 16.5x8.4 mm

1 Top view 2 Side view 3 Back view

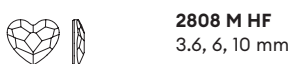
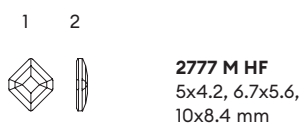

Crystal Diamonds

1360 (with art. 1028 XILION Chaton)¹

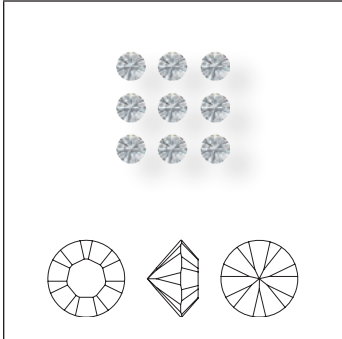

1360 (with art. 1088 XIRIUS Chaton)¹

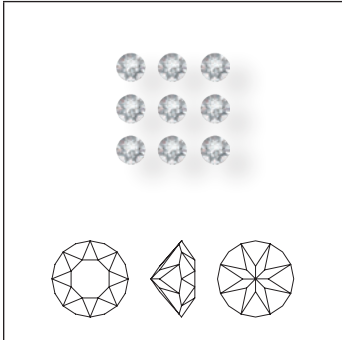

Crystal Diamonds & Metallics

1360 ¹	Size	PP 7 (PP7 with art. 1028 XILION Chaton)	PP 12 (PP12 with art. 1028 XILION Chaton)	PP 17 (PP17 with art. 1088 XIRIUS Chaton)
Crystal				
Crystal (001)		<input checked="" type="checkbox"/>	<input checked="" type="checkbox"/>	<input checked="" type="checkbox"/>
Colors				
Plain Colors				
Black Diamond (215)		<input checked="" type="checkbox"/>	<input checked="" type="checkbox"/>	<input checked="" type="checkbox"/>
Crystal Effects				
Transparent Effects				
Crystal Aurore Boreale (001 AB)		<input checked="" type="checkbox"/>	<input checked="" type="checkbox"/>	<input checked="" type="checkbox"/>

¹The article is only available within a Transfer, not as a loose stone

Metallics

To add a metallic look to your Transfer, you may choose from our Metallics assortment and simply include them into your Design.



3490
3490/006
(M2)



3490
3490/400
(M4)



3490
3490/007
(M10)



3490
3490/012
(M2.5)



3490
3490/600
(M6)



3490
3490/300
(M3)



3490
3490/008
(M8)



Gold¹ brushed
(081)



Silver brushed
(082)



Gun metal
brushed
(086)



Gold¹ polished
(091)



Silver polished
(092)



Gun metal
polished
(096)



Bronze brushed
(084)



Copper brushed
(080)



Black polished
(070)



Bronze polished
(094)



Copper polished
(090)



Signal White
(R 9003²)



Jet Black
(R 9005²)

¹ Golden colored

² Color tones according to RAL colors.

Crystal Transfers and Inspirational Motifs

ARTICLE EXPLANATION

944269

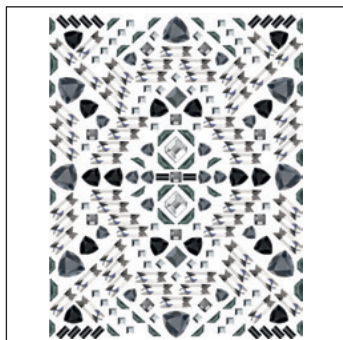

C	280/001LTCH/001SINI/001/ 280HEM/215/215/001/253/ 280/253
E	CS5x2.5/CS3x3/CS4x4/ 2555MM12x4/2400MM6/ 2772MM6.5x2.1/2772MM8.6x2.8/ 2777MM10x8.4/2472MM5/ 2472MM7/2472MM10
S	~95x122
M	4 PCS 35%

944269	C	E	S	M	35%
Article number	Color assortment	Elements	Motif size in mm	Minimum order quantity in pieces (PCS)	% of actual size
	Color code 1 (280) corresponds to element 1 (CS5x2.5); color code 2 (001LTCH) corresponds to element 2 (CS3x3) etc.	For details of stone sizes and element codes, please refer to the product charts at the beginning of this chapter.			
	For details please refer to the product charts at the beginning of this chapter and the chapter Flat Backs Hotfix pages 84–113.				

ORDERING EXAMPLE & PRODUCT VARIETY EXPLANATION

944269	C280	001LTCH
Article number	Color of crystals corresponding to element 1; color of the most frequently used element in the motif	Color of crystals corresponding to element 2; color of the second most frequently used element in the motif

MOTIFS & ROWS

13 458

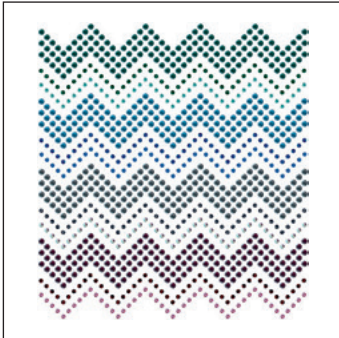

C 229SHIM/243/369SHIM/253/
539SHIM/208/227SHIM/205/
205 NIFA/243NIFA/253NIFA/
208NIFA

E S6/S6/S6/S6/S6/S6/S6/
S10/S10/S10/S10

S ~124x135

M 3 PCS **23%**

13 460

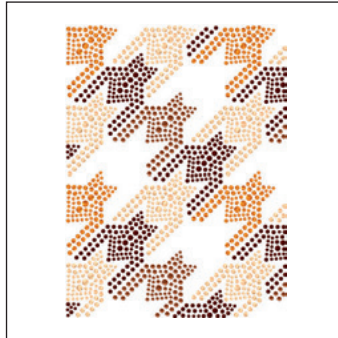

C R8012/R8012/R8012-001GSHA/
203/1001/001GSHA/203/
1001/001GSHA/203/1001/
001GSHA/203/1001

E M2/M2.5/M3-S6/S6/S6/S8/S8/
S8/S10/S10/S10/S16/S16

S ~130x172

M 3 PCS **18%**

13 461

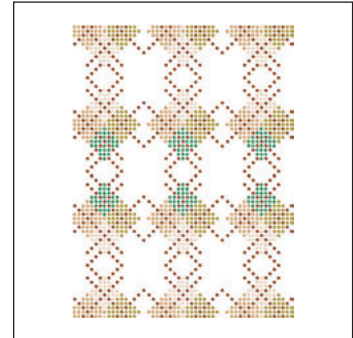

C 1001/246/1003/391/360

E S6/S6/S6/S6/S6

S ~129x172

M 3 PCS **18%**

13 462

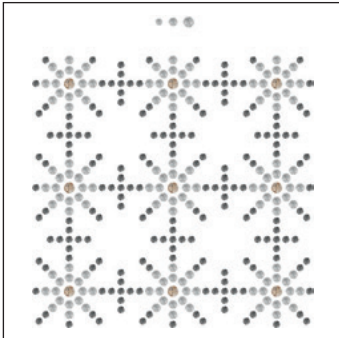

C 001GSHA/001/001SINI/
001/001

E 1098SS20/1098SS20/1098PP24/
1098PP24/1098PP31

S ~124x137

M 7 PCS **30%**

13 464

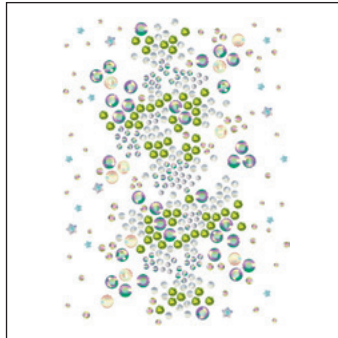

C 001TRAHFT/001L144D/
001PARSH/001TRAHFT/234/
001TRAHFT/337/001PARSH/
001AB/202/001AB

E S8/S10/S12/S12/S16/S16/S20/
S34/S34/2754MM4/2754MM6

S ~119x162

M 3 PCS **25%**

13 465



C R6018/R4005-001191/202/223/
209/214/001PARSH/226/502/
001AB/001AB/001/001GSHA

E M2/M2-P3/S3/S3/S6/S6/S6S6/
S12/2200MM4X2/2754MM4/
2754MM6/2201MM4.OX1.8

S ~111x153

M 3 PCS **28%**

13 466

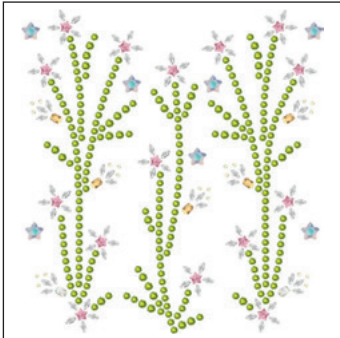

C 001AB/337/337/209/001AB/
001GSHA/001AB/001

E S3/S8/S10/2754MM4/
2754MM6/2602MM3.7X2.5/
2602MM3.7X2.5/
2201MM4.0X1.8

S ~99x107

M 4 PCS **40%**

13 467

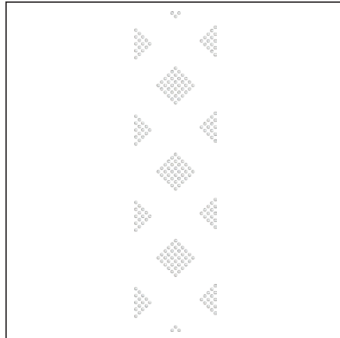

C 001650

E P2

S ~44x169

M 20 PCS **25%**

13 468

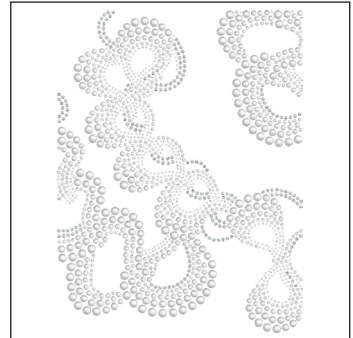

C 001650/001650/001650/
001650/001/001MOL

E P3/P4/P2/P5/S3/S6

S ~130x170

M 3 PCS **25%**

Inspirational Motifs

13 469

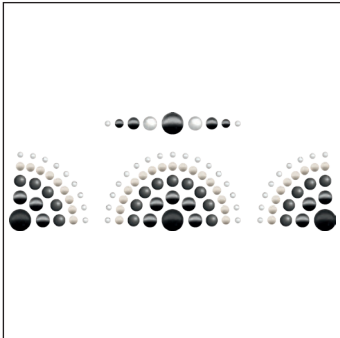

C 001191/280HEM/001617/
280HEM/280/280HEM/001650/
001650/280HEM/001650

E P3/P3/P4/P4/P7/P7/P2/P2/
P5/P5

S ~105x38

M 16 PCS **41%**

13 470

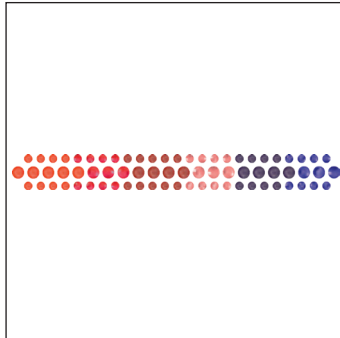

C 001L160I/001L159I/001L161I/
539/542/257/001L159I/
001L160I/001L161I/539/542/257

E S10/S10/S10/S10/S10/S10/
S16/S16/S16/S16/S16/S16

S ~103x11

M 40 PCS **42%**

13 471

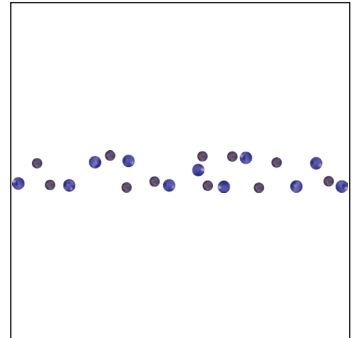

C 001L161I/539

E S16/S20

S ~122x16

M 49 PCS **29%**

13 472

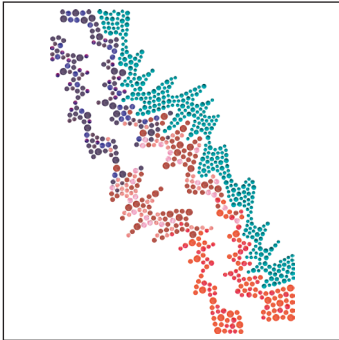

C 263/263/257/542/219/001VOL/
263/001L160L/001L159I/
001L161I/539/223/542/
001L160L/001L161I/001L159I

E S6/S8/S8/S8/S8/S8/S10/S10/
S10/S10/S12/S12/S12/S16/
S16/S16

S ~129x172

M 5 PCS **20%**

13 473

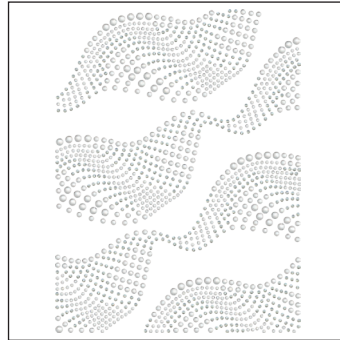

C 001650/001650/001650/
001MOL

E P3/P4/P2/S6

S ~129x171

M 3 PCS **20%**

13 475

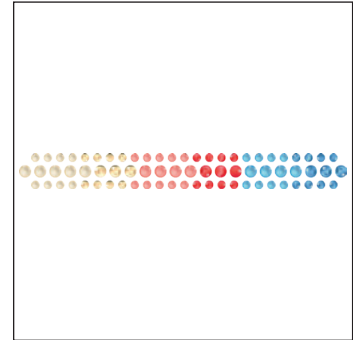

C 001L162I/001L164I/001L163I/
211/261/262/001L164I/001L162I/
001L163I/211/261/262

E S10/S10/S10/S10/S10/S10/
S16/S16/S16/S16/S16/S16

S 103x11

M 40 PCS **42%**

13 476

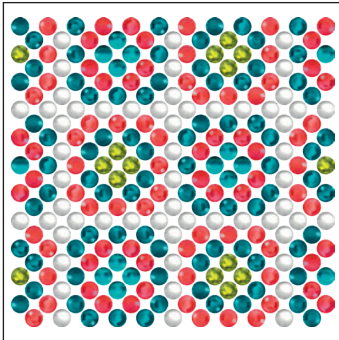

C 001650/229/262/542/337/263

E P7/S34/S34/S34/S34/S34

S ~126x120

M 3 PCS **34%**

13 477

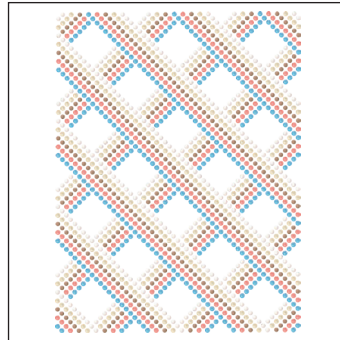

C R1019/R9003-001L164I/
001L162I/001L163I

E M2.5/M2.5-S10/S10/S10

S ~129x170

M 3 PCS **25%**

13 478

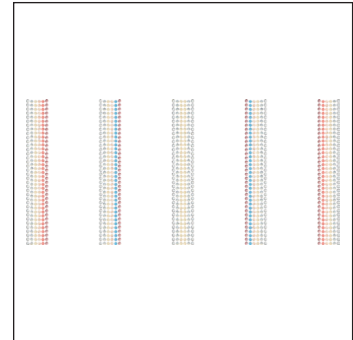

C 001650/001294/001L164I/234/
391/001L162I/001L163I

E P3/P3/S10/S10/S10/S10/S10

S ~259x120

M 1 PCS **16%**

13 479

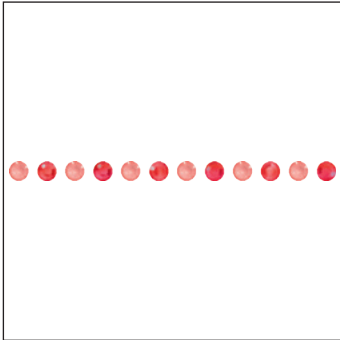

C 00111621/542/262
E S16/S16/S16
S ~966x4 (44 SEG/ROW)
M 12 ROWS **67%**

13 480

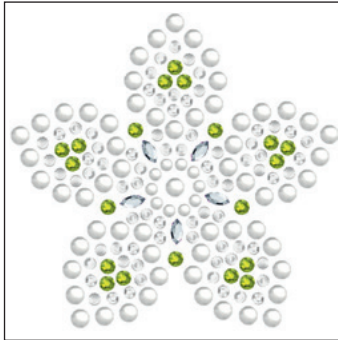

C 001650/001650/001/337/001
E P3/P2/S6/S8/2200MM4x2
S ~51x49
M 21 PCS **85%**

13 481

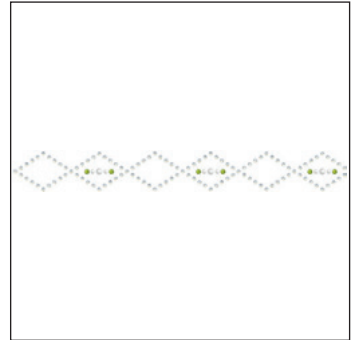

C 001650/001650/234/337
E P3/P2/S6/S8
S ~979x19 (18 SEG/ROW)
M 7 ROWS **27%**

Inspirational Motifs

13 482

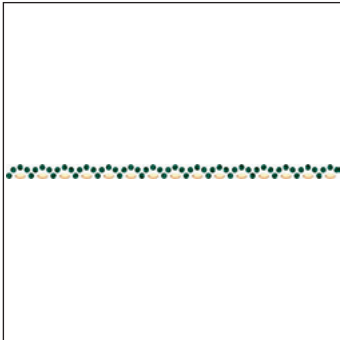

C 205/001GSHA
E S6/2200MM4x2
S ~985x5 (25 SEG/ROW)
M 13 ROWS **37%**

13 483



C 001GSHA/001GSHA/215
E S3/S8/2777MM5x4.2
S ~472x6 (12 SEG/ROW)
M 12 ROWS **37%**

13 484

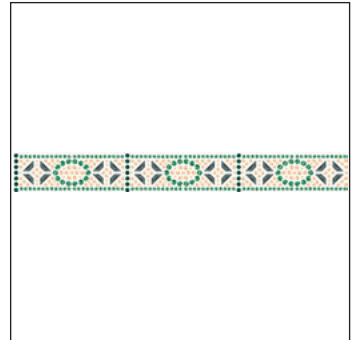

C 001GSHA/360/001GSHA/001GSHA/205/360/215
E S3/S6/S6/S8/S8/S12/2772MM8.6x2.8
S ~466x23 (7 SEG/ROW)
M 6 ROWS **22%**

13 485

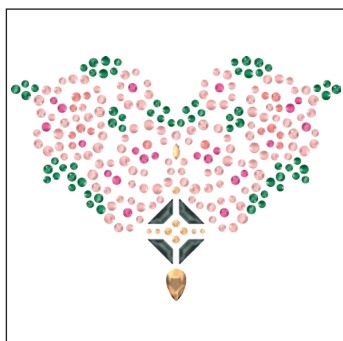

C 001GSHA/319/360/257/209/
001GSHA/319/360/209/257/
319/001GSHA/001GSHA/215

E S3/S6/S6/S6/S6/S6/S8/S8/
S8/S8/S10/2303MM8x5/
2200MM4x2/2772MM8.6x2.8

S ~81x60

M 15 PCS **54%**

13 486



C 001650/001/215/001/001

E P2/CS8x5/S3/S8/S10

S ~92x92

M 10 PCS **45%**

13 487

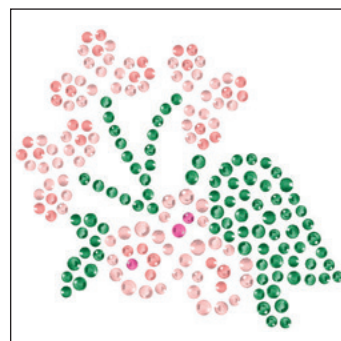

C 360/319/257/209/360/319/
257/209/319

E S6/S6/S6/S6/S8/S8/S8/S8/S10

S ~56x51

M 28 PCS **77%**

13 488

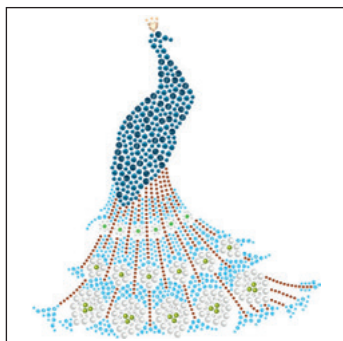

C 001650/202/1001/001/
001GSHA/202/243NIFA/
001/214/337/243NIFA/
266/001GSHA

E P3/S3/S3/S3/S3/S6/S6/S6/
S6/S8/S10/S12/2472MM5

S ~135x152

M 3 PCS **28%**

944269

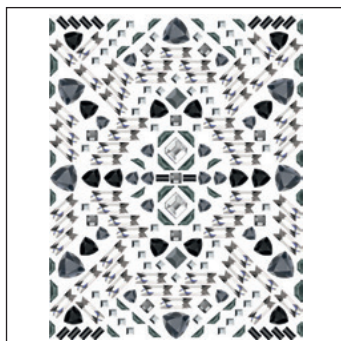

C 280/001ITCH/001SINI/001/
280HEM/215/215/001/253/
280/253

E CS5x2.5/CS3x3/CS4x4/
2555MM12x4/2400MM6/
2772MM6.5x2.1/2772MM8.6x2.8/
2777MM10x8.4/2472MM5/
2472MM7/2472MM10

S ~95x122

M 4 PCS **35%**

944589

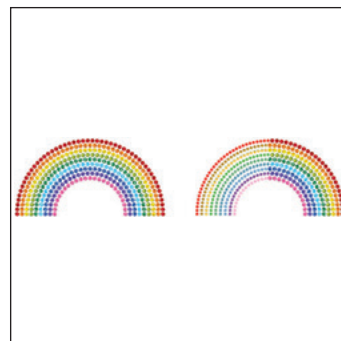

C 227/1003/001METSH/214/
214SHIM/211SHIM/211/
502SHIM/223/327/203/226/
337/360/202/206/539/209

E S6/S6/S6/S6/S6/S6/S6/S6/
S6/S10/S10/S10/S10/S10/
S10/S10/S10/S10

S ~218x51

M 7 PCS **20%**

944590

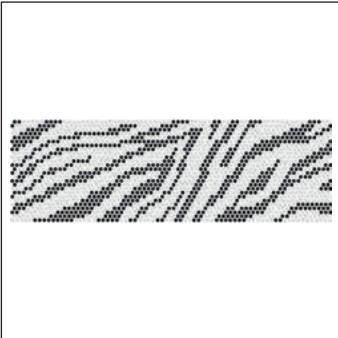

C 001/280
E S6/S6
S ~170x54
M 15 PCS **25%**

944591

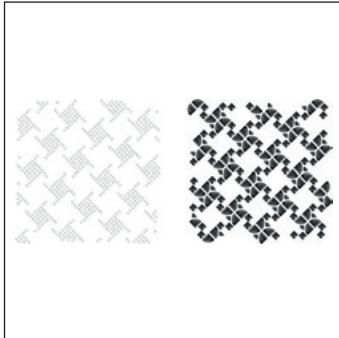

C 280/001/280/280
E CS4x4/S6/2715MM30/
2715MM60
S ~220x100
M 4 PCS **19%**

944592



C 280HEM/001/280HEM/001/
001/001/001/001/280HEM/
001SINI/001SSHA/280/253/
253
E P4/CS8x5/S10/2205MM7.5/
2201MM8x3.5/2303MM8x5/
2200MM4x2/2400MM2.2/
2771MM6.4x4.2/2364MM6x3.7/
2365MM6x3.7/2471MM5/
2472MM5/2603MM4x3
S ~154x45
M 8 PCS **28%**

944593



C 001/001
E S3/S6
S ~378x112
M 1 PCS **11%**

944594



C 001
E PP7
S ~228x8
M 16 PCS **19%**

SPECIAL MOTIF SERVICE

A special motif is any individual design created by the customer that differs to the Crystal Transfers Inspirational Collection. This service opens up an abundance of customization possibilities. You also no longer need to set your motif by hand. You can rely on Swarovski's long-standing experience and design expertise and can order a convenient, ready-to-apply design. A range of customization options for existing motifs is

Customization Possibilities

- Change of elements in an existing motif
- Change of size of an existing motif
- Logos or brand names
- Your desired design
- Up to 18 elements or colors possible per Transfer motif

Ordering Process

Send your request with the drawing you wish to order to your nearest Swarovski sales office. Make sure you include all measurements for the desired motif. Please also indicate which product group your special motif applies to (Crystal Transfers, Crystal-it, Crystal Mesh, etc.). You will then receive a quotation including your article number,

Please Note

Please always submit the drawing of your desired motif to represent it in the actual size you require. A small sketch, when enlarged to the desired size, will have blurred lines that will make it difficult to correctly reproduce. Pictures or drawings representing 100% size of the design or very good quality scans in JPG, BMP, or DXF format will ensure that we have clear data to work with. These can also be sent via email. When the sketch is submitted as a copy by email, please include a scale legend (e.g. copy/scan

available (see "Customization Possibilities" below). You can also submit design sketches that meet your special requirements – such as a brand image or an image for a particular sales campaign or garment. This will then be made up according to your specifications using Computer Aided Design, which means that adjustments can be made easily according to your needs.

minimum order quantity, price, and the line drawing of your special motif in PDF format. Please contact your Swarovski sales office again if any changes are required. Your special motif will be produced and delivered following your confirmation.

with a ruler next to the drawing). This will ensure that the desired size of the motif can be identified.

Special productions are generally offered to all our customers if these are deemed to be feasible and comply with our General Terms and Conditions. Please note that ordering a design does not grant exclusive production of this design to the customer.

Crystal-it Infinity

Crystal-it Infinity is made up of Flat Backs in different shapes, sizes, and colors. You may use up to 9 different elements per motif.

It is an easy-to-apply product thanks to the specially developed self-adhesive glue on the back of the stones. You can create your own individual and exclusive Crystal-it Infinity designs with Swarovski's special motif service.

ARTICLE EXPLANATION

75 516



C	001/001SSHA/001SINI/280/280HEM
E	S6/S6/S6/CS3x3/CS3x3
S	~32x32 (TAPE : 75x53)
M	200 PCS 100%

Crystal-it Infinity

75 516	C	E	S	M	100%
Article number	Color assortment	Elements	Motif size in mm	Minimum order quantity in pieces (PCS)	% of actual size
	For further details, please refer to the color and product charts at the beginning of this chapter. Color code 1 (001) corresponds to element 1 (S6); color code 2 (001SSHA) corresponds to element 2 (S6) etc.	For details of stone sizes and element codes, please refer to the color and product charts at the beginning of this chapter.	Size of the tape the motif is attached to in mm (TAPE)		

Please note: Due to their physical properties, Swarovski's self adhesive products are unsuitable for other uses such as gluing onto teeth, using on or near mucous membranes, and other unsafe uses.

ORDERING EXAMPLE & PRODUCT VARIETY EXPLANATION

75 516	022	001	001SSHA	001SINI	280
Article number	Carrier film color 022 White	Crystal color corresponding to element 1, color of most frequently used element in the motif. Please see the respective color chart for all available reference codes.	Crystal color corresponding to element 2, color of second most frequently used element in the motif.	Crystal color corresponding to element 3, color of third most frequently used element in the motif.	Crystal color corresponding to element 4, color of fourth most frequently used element in the motif.

FLAT BACKS FOR CRYSTAL-IT INFINITY

2038 XILION Rose

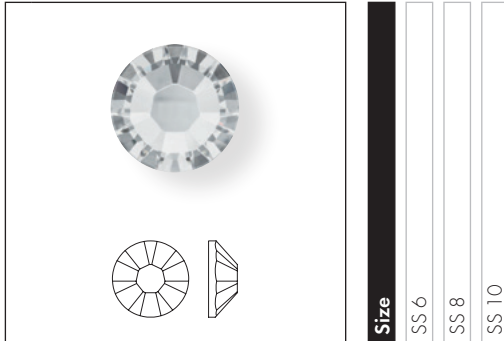

Size
SS 6
SS 8
SS 10

Crystal	SS 6	SS 8	SS 10
Crystal (001)	■	■	■
Colors			
Plain Colors			
Amethyst (204)	■	■	■
Aquamarine (202)	■	■	■
Fuchsia (502)	■	■	■
Greige (284)	■	■	■
Indian Siam (327)	■	■	■
Jet (280)	■	■	■
Light Peach (362)	■	■	■
Light Rose (223)	■	■	■
Montana (207)	■	■	■
Peridot (214)	■	■	■
Sapphire (206)	■	■	■
Siam (208)	■	■	■
Tanzanite (539)	■	■	■
Topaz (203)	■	■	■
Crystal Effects			
Transparent Effects			
Crystal Aurore Boreale (001 AB)	■	■	■
Crystal Golden Shadow (001 GSHA)	■	■	■
Crystal Silver Night (001 SINI)	■	■	■
Crystal Silver Shade (001 SSHA)	■	■	■
Metallic Effects			
Crystal Light Chrome (001 LTCH)	■	■	■
Color Effects			
Metallic Effects			
Jet Hematite (280 HEM)	■	■	■

2078 XIRIUS Rose



Size
SS 12
SS 16

Crystal	SS 12	SS 16
Crystal (001)	■	■
Colors		
Plain Colors		
Amethyst (204)	■	■
Aquamarine (202)	■	■
Fuchsia (502)	■	■
Greige (284)	■	■
Indian Siam (327)	■	■
Jet (280)	■	■
Light Peach (362)	■	■
Light Rose (223)	■	■
Montana (207)	■	■
Peridot (214)	■	■
Sapphire (206)	■	■
Siam (208)	■	■
Tanzanite (539)	■	■
Topaz (203)	■	■
Crystal Effects		
Transparent Effects		
Crystal Aurore Boreale (001 AB)	■	■
Crystal Golden Shadow (001 GSHA)	■	■
Crystal Silver Night (001 SINI)	■	■
Crystal Silver Shade (001 SSHA)	■	■
Metallic Effects		
Crystal Light Chrome (001 LTCH)	■	■
Color Effects		
Metallic Effects		
Jet Hematite (280 HEM)	■	■

Crystal-it Infinity

2300 Drop Flat Back

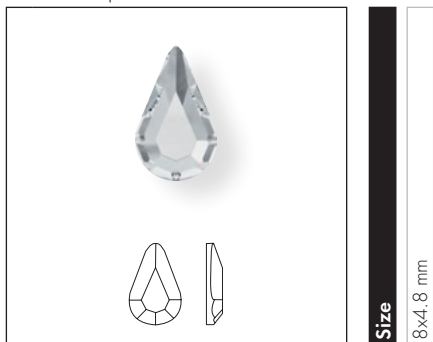

Size

8x4.8 mm

Crystal

Crystal (001)

Colors

Plain Colors

Jet (280)

Crystal Effects

Transparent Effects

Crystal Aurore Boreale (001 AB)

Crystal Golden Shadow (001 GSHA)

2400 Square Flat Back

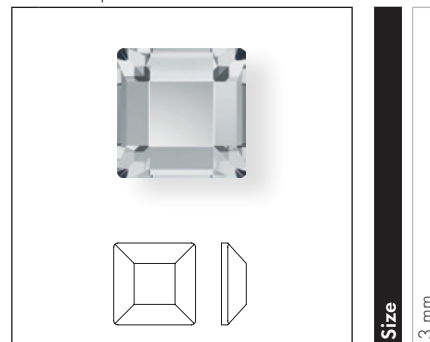

Size

3 mm

Crystal

Crystal (001)

Colors

Plain Colors

Jet (280)

Crystal Effects

Transparent Effects

Crystal Aurore Boreale (001 AB)

Crystal Golden Shadow (001 GSHA)

Color Effects

Metallic Effects

Jet Hematite (280 HEM)

2510 Baguette Flat Back

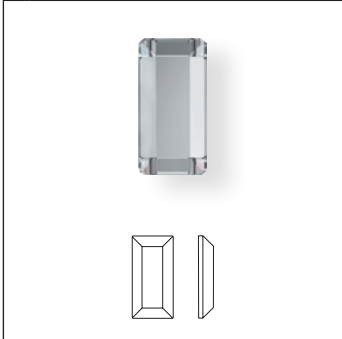

Size
5x2.5 mm

Crystal

Crystal (001)

Colors

Plain Colors

Jet (280)

Crystal Effects

Transparent Effects

Crystal Aurore Boreale (001 AB)

Crystal-it Infinity

INSPIRATIONAL MOTIFS

75 517

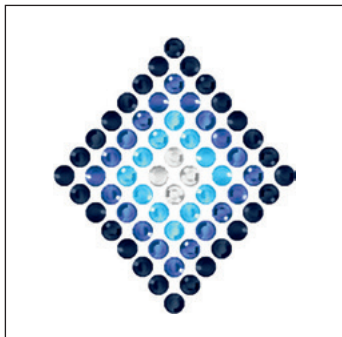

C 207/206/202/001
E S10/S10/S10/S10
S ~32x36 (TAPE : 75x53)
M 200 PCS **100%**

75 519

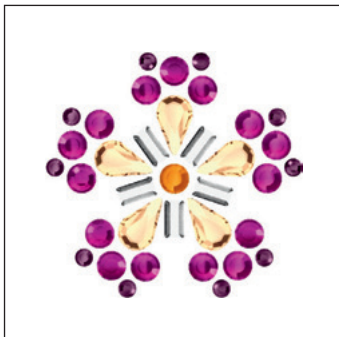

C 204/502/203/001GSHA/001
E S8/S16T/S16T/CS8x5/CS5x2.5
S ~34x32 (TAPE : 75x53)
M 200 PCS **100%**

75 520

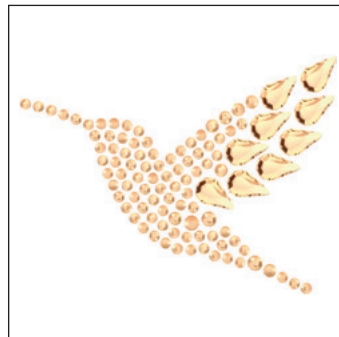

C 001GSHA/001GSHA/001GSHA/
001GSHA
E S6/S8/S10/CS8x5
S ~56x42 (TAPE : 75x105)
M 100 PCS **75%**

75 522

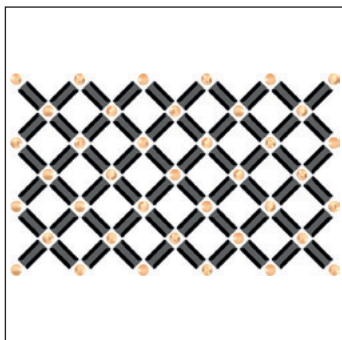

C 001GSHA/280
E S6/CS5x2.5
S ~58x35 (TAPE : 75x53)
M 200 PCS **75%**

75 523

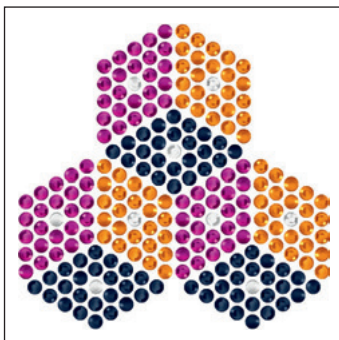

C 203/207/502/001
E S6/S6/S6/S6
S ~41x41 (TAPE : 75x105)
M 100 PCS **100%**

SPECIAL MOTIF SERVICE

A special motif is any individual design created by the customer that differs to the Self-adhesive Elements Standard or Crystal Inspirations Collections. This service opens up an abundance of customization possibilities and enables you to profit from Swarovski's long-standing experience and design expertise. A range of customization options for existing motifs is also available (see

"Customization Possibilities" below). You can also submit design sketches that meet your special requirements, such as a brand image or an image for a particular sales campaign. This will then be made up according to your specifications using Computer Aided Design, which means that adjustments can be made easily according to your needs.

Customization Possibilities for Crystal-It Infinity

- Change of elements and colors of elements of an existing motif
- Change of size of an existing motif
- Logos or brand names
- Up to 9 different elements per motif are possible

Ordering Process

Send your request with the drawing you wish to order to your nearest Swarovski sales office. Make sure you include all measurements for the desired motif. Please also indicate which product group your special motif applies to (Crystal-it, Crystal Fabric-it, Crystaltex-it, Crystaltex-it Chaton, Crystal Fine Rocks-it). You will then receive

a quotation including your article number, minimum order quantity, price, and the line drawing of your special motif in PDF format. Please contact your Swarovski sales office again if any changes are required. Your special motif will be produced and delivered following your confirmation.

Please Note

Please always submit the drawing of your desired motif to represent it in the actual size you require. A small sketch, when enlarged to the desired size, will have blurred lines that will make it difficult to correctly reproduce. Pictures or drawings representing 100% size of the design or very good quality scans in JPG, BMP, or DXF format will ensure that we have clear data to work with. These can also be sent via email. If you are sending a sewing pattern, please include the whole pattern and not just sections. When the sketch is submitted as a copy by email, please include a scale legend (e.g. copy/scan with a ruler next to the drawing). This will ensure that the desired size of the motif can be identified.

Special productions are generally offered to all our customers if these are deemed to be feasible and comply with our General Terms and Conditions. Please note that ordering a design does not grant exclusive production of this design to the customer.

If detailed information on potential tolerances is needed (e.g. cavity production for metal parts), please contact Swarovski who will enter an application request into our application database.

