

Pendants

Exuding timeless elegance, available in a large range of classic, and avant-garde cuts and shapes, Pendants are offered in a captivating variety of colors and effects. Unlocking multiple design arenas with their easy application – the top hole requires only a jump ring or pinch bail with a chain or cord – the diverse size range ensures Pendants are perfect for jewelry sets, as well as apparel, and accessories.





Colors & Effects

OPEN TO SEE COLORS & EFFECTS











Colors

 Crystal 001	 Majestic Blue 296
 Light Rose 223	 Montana 207
 Rose Peach 262	 Denim Blue 266
 Padparadscha 542	 Light Turquoise 263
 Rose 209	 Blue Zircon 229
 Fuchsia 502	 Erinite 360
 Light Siam 227	 Peridot 214
 Scarlet 276	 Citrus Green 337
 Siam 208	 Fern Green 291
 Ruby 501	 Emerald 205
 Amethyst 204	 Jonquil 213
 Iris 219	 Light Topaz 226
 Light Amethyst 212	 Golden Topaz 1003
 Violet 371	 Light Colorado Topaz 246
 Tanzanite 539	 Topaz 203
 Aquamarine 202	 Light Amber 1002
 Light Sapphire 211	 Smoked Amber 1001
 Sapphire 206	 Jet 280
 Capri Blue 243	

Effects

 Crystal Moonlight 001 MOL
 Crystal Shimmer 001 SHIM
 Crystal Aurore Boreale 001 AB
 Crystal Antique Pink 001 ANTP
 Crystal Vitrail Light 001 VL
 Crystal Paradise Shine 001 PARSH
 Crystal Vitrail Medium 001 VM
 Crystal Heliotrope 001 HEL
 Crystal Bermuda Blue 001 BBL
 Crystal Bermuda Blue 001 BBL P
 Crystal Blue Shade 001 BLSH
 Crystal Golden Shadow 001 GSHA
 Crystal Light Chrome 001 LTCH
 Crystal Silver Shade 001 SSHA
 Crystal Silver Night 001 SINI

AB Effects

 Light Rose Aurore Boreale 223 AB
 Rose Aurore Boreale 209 AB
 Fuchsia Aurore Boreale 502 AB
 Light Siam Aurore Boreale 227 AB
 Siam Aurore Boreale 208 AB
 Violet Aurore Boreale 371 AB
 Aquamarine Aurore Boreale 202 AB
 Sapphire Aurore Boreale 206 AB
 Blue Zircon Aurore Boreale 229 AB
 Peridot Aurore Boreale 214 AB
 Light Topaz Aurore Boreale 226 AB

Shimmer Effects

 Light Rose Shimmer 223 SHIM
 Light Siam Shimmer 227 SHIM
 Amethyst Shimmer 204 SHIM
 Light Amethyst Shimmer 212 SHIM
 Aquamarine Shimmer 202 SHIM
 Light Sapphire Shimmer 211 SHIM
 Emerald Shimmer 205 SHIM
 Light Topaz Shimmer 226 SHIM
 Light Colorado Topaz Shimmer 246 SHIM

Numerical Order

001	Crystal	206 AB	Sapphire Aurore Boreale	229 AB	Blue Zircon Aurore Boreale
001 AB	Crystal Aurore Boreale	206	Sapphire	229	Blue Zircon
001 ANTP	Crystal Antique Pink	207	Montana	243	Capri Blue
001 BBL P	Crystal Bermuda Blue	208 AB	Siam Aurore Boreale	246 SHIM	Light Colorado Topaz Shimmer
001 BBL	Crystal Bermuda Blue	208	Siam	246	Light Colorado Topaz
001 BLSH	Crystal Blue Shade	209 AB	Rose Aurore Boreale	262	Rose Peach
001 GSHA	Crystal Golden Shadow	209	Rose	263	Light Turquoise
001 HEL	Crystal Heliotrope	211 SHIM	Light Sapphire Shimmer	266	Denim Blue
001 LTCH	Crystal Light Chrome	211	Light Sapphire	276	Scarlet
001 MOL	Crystal Moonlight	212 SHIM	Light Amethyst Shimmer	280	Jet
001 PARSH	Crystal Paradise Shine	212	Light Amethyst	291	Fern Green
001 SHIM	Crystal Shimmer	213	Jonquill	296	Majestic Blue
001 SINI	Crystal Silver Night	214 AB	Peridot Aurore Boreale	337	Citrus Green
001 SSHA	Crystal Silver Shade	214	Peridot	360	Erinite
001 VL	Crystal Vitrail Light	219	Iris	371 AB	Violet Aurore Boreale
001 VM	Crystal Vitrail Medium	223 AB	Light Rose Aurore Boreale	371	Violet
202 AB	Aquamarine Aurore Boreale	223 SHIM	Light Rose Shimmer	501	Ruby
202 SHIM	Aquamarine Shimmer	223	Light Rose	502 AB	Fuchsia Aurore Boreale
202	Aquamarine	226 AB	Light Topaz Aurore Boreale	502	Fuchsia
203	Topaz	226 SHIM	Light Topaz Shimmer	539	Tanzanite
204	Amethyst	226	Light Topaz	542	Padparadscha
204 SHIM	Amethyst Shimmer	227 AB	Light Siam Aurore Boreale	1001	Smoked Amber
205 SHIM	Emerald Shimmer	227 SHIM	Light Siam Shimmer	1002	Light Amber
205	Emerald	227	Light Siam	1003	Golden Topaz

Alphabetical Order

Amethyst (204)	Crystal Vitrail Medium (001 VM)	Light Siam Shimmer (227 SHIM)
Amethyst Shimmer (204 SHIM)	Denim Blue (266)	Light Topaz (226)
Aquamarine (202)	Emerald (205)	Light Topaz Aurore Boreale (226 AB)
Aquamarine Aurore Boreale (202 AB)	Emerald Shimmer (205 SHIM)	Light Topaz Shimmer (226 SHIM)
Aquamarine Shimmer (202 SHIM)	Erinite (360)	Light Turquoise (263)
Blue Zircon (229)	Fern Green (291)	Majestic Blue (296)
Blue Zircon Aurore Boreale (229 AB)	Fuchsia (502)	Montana (207)
Capri Blue (243)	Fuchsia Aurore Boreale (502 AB)	Padparadscha (542)
Citrus Green (337)	Golden Topaz (1003)	Peridot (214)
Crystal (001)	Iris (219)	Peridot Aurore Boreale (214 AB)
Crystal Antique Pink (001 ANTP)	Jet (280)	Rose (209)
Crystal Aurore Boreale (001 AB)	Jonquill (213)	Rose Aurore Boreale (209 AB)
Crystal Bermuda Blue (001 BBL P)	Light Amber (1002)	Rose Peach (262)
Crystal Bermuda Blue (001 BBL)	Light Amethyst (212)	Ruby (501)
Crystal Blue Shade (001 BLSH)	Light Amethyst Shimmer (212 SHIM)	Sapphire (206)
Crystal Golden Shadow (001 GSHA)	Light Colorado Topaz (246)	Sapphire Aurore Boreale (206 AB)
Crystal Heliotrope (001 HEL)	Light Colorado Topaz Shimmer (246 SHIM)	Scarlet (276)
Crystal Light Chrome (001 LTCH)	Light Rose (223)	Siam (208)
Crystal Moonlight (001 MOL)	Light Rose Aurore Boreale (223 AB)	Siam Aurore Boreale (208 AB)
Crystal Paradise Shine (001 PARSH)	Light Rose Shimmer (223 SHIM)	Smoked Amber (1001)
Crystal Shimmer (001 SHIM)	Light Sapphire (211)	Tanzanite (539)
Crystal Silver Night (001 SINI)	Light Sapphire Shimmer (211 SHIM)	Topaz (203)
Crystal Silver Shade (001 SSHA)	Light Siam (227)	Violet (371)
Crystal Vitrail Light (001 VL)	Light Siam Aurore Boreale (227 AB)	Violet Aurore Boreale (371 AB)

For details on available colors and effects for each article within the product groups, please see the product matrix of the respective item in the Collection 2023.













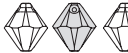

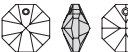

















The plating resistance of effects is tested according to Swarovski's plating guidelines (SWAROVSKI.COM/S-PROFESSIONALS). Customers are advised to carry out their own tests if their plating parameters diverge from Swarovski plating guidelines.

Colors and effects can appear different when illuminated with different light sources. Swarovski uses standard light source D65 for color decision and comparison. Slight changes in shades are unavoidable. Colors may vary according to cut and foiling.

The composition of Advanced Crystal is compliant with regulatory industry norms and laws regarding the restriction or prohibition of certain substances in the most relevant segments of our customers. Please note that the compliance of the colors Light Siam and Siam varies according to certain industry regulations. Those regulations are indicated with * in the compliance overview. Indian Siam, Ruby and Scarlet (option to Lt. Siam) conform to all CLEAR-lists. For further information please visit [swarovski.com/s-professionals](https://www.swarovski.com/s-professionals)

© 2023 D. Swarovski Distribution GmbH

Summary

1 2 3  6000 11x5.5, 13x6.5, 15x7.5, 22x11 mm	1 2 3  6090 16x11, 22x15 mm	1 2 3  6328 6, 8 mm
 6002 10x7, 15x11.5 mm	 6100 24x12 mm	 6401 8 mm
 6007 7x4, 9x5 mm	 6106 16, 22, 28, 38 mm	 6428 6, 8, 12 mm
 6010 11x5.5, 13x6.5, 17x8.5, 21x10.5 mm	 6128 8, 10, 12 mm	 6430 8, 10, 14 mm
 6015 17, 21 mm	 6210 12, 17 mm	 6431 9, 11.5, 16 mm
 6017/G 30, 56 mm	 6215 18 mm	 6432 8, 10.5, 14.5 mm
 6020 18, 30, 37 mm	 6225 10, 18, 28 mm	 6433 9, 11.5, 16 mm
 6022 14, 24 mm	 6228 10.3x10, 14.4x14, 18x17.5, 28, 40 mm	 6434 8, 10.5, 14.5 mm
 6028 8, 10, 12, 18 mm	 6240 12, 17, 27 mm	 6435 9, 11.5, 16 mm
 6040 20, 30, 40 mm	 6261 17, 27 mm	 6436 9, 11.5, 16 mm
 6049 20, 30 mm	 6264 18, 28 mm	 6438 9, 11.5, 16 mm

1 Front view 2 Side view 3 Back view

"1 Front view" or "3 Back view" shaded in gray: surface effect is applied to this side.

"2 Side view" shaded in gray: side of surface effect not defined (for all symmetrical and some asymmetrical articles).

Where all views are shaded in gray, the effect is applied over the entire marked surface.

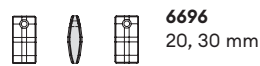
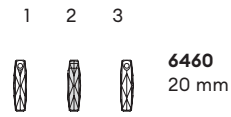

1 Front view 2 Side view 3 Back view

"1 Front view" or "3 Back view" shaded in gray: the surface effect is applied to this side.

"2 Side view" shaded in gray: side of surface effect not defined (for all symmetrical and some asymmetrical articles).

6721: 16, 20 mm: no defined side for surface effect; 28, 40 mm surface effect on "3 Back view."

6864: Reverse effect "V" is the standard version and is therefore shaded.

6000 Classic Drop Pendant

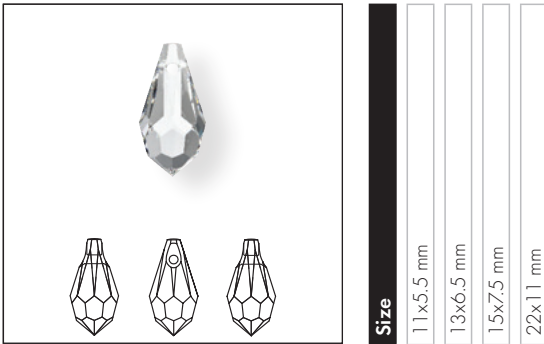

Size
11x5.5 mm
13x6.5 mm
15x7.5 mm
22x11 mm

Crystal	11x5.5 mm	13x6.5 mm	15x7.5 mm	22x11 mm
Crystal (001)	■	■	■	■
Colors				
Plain Colors				
Amethyst (204)	■			
Aquamarine (202)	■			
Blue Zircon (229)	■			
Emerald (205)	■			
Jet (280)	■	■	■	
Light Amethyst (212)	■			
Light Siam (227)	■			
Majestic Blue (296)	■			
Peridot (214)	■			
Rose (209)	■			
Sapphire (206)	■			
Scarlet (276)	■			
Siam (208)	■	■	■	
Tanzanite (539)	■			
Topaz (203)	■			
Crystal Effects				
Transparent Effects				
Crystal Aurore Boreale (001 AB)	■	■	■	■
Crystal Paradise Shine (001 PARSH)	■			

6002 Oval Disco Pendant

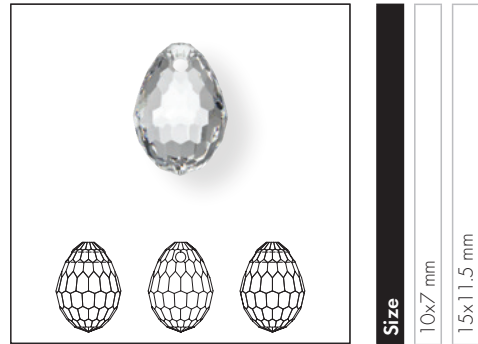

Size
10x7 mm
15x11.5 mm

Crystal	10x7 mm	15x11.5 mm
Crystal (001)	■	■
Crystal Effects		
Transparent Effects		
Crystal Aurore Boreale (001 AB)	■	■

6007 Small Briolette Pendant

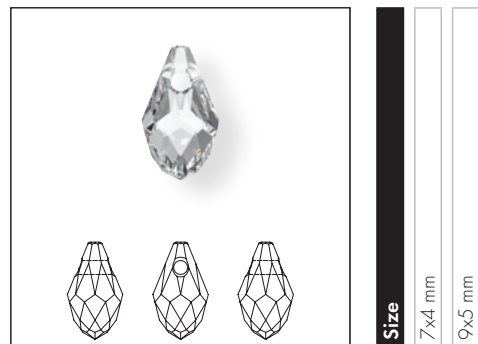

Size
7x4 mm
9x5 mm

Crystal	7x4 mm	9x5 mm
Crystal (001)	■	■
Crystal Effects		
Transparent Effects		
Crystal Aurore Boreale (001 AB)	■	■
Crystal Golden Shadow (001 GSHA)	■	■

6010 Briolette Pendant



Size 11x5.5, 13x6.5, 17x8.5, 21x10.5 mm

6106 Pear-shaped Pendant

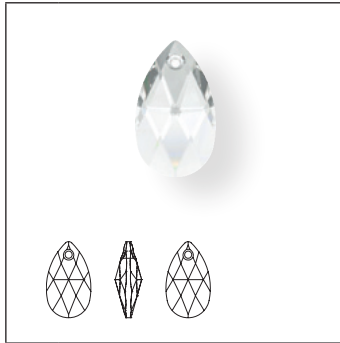

Size 16, 22, 28, 38 mm

6228 XILION Heart Pendant

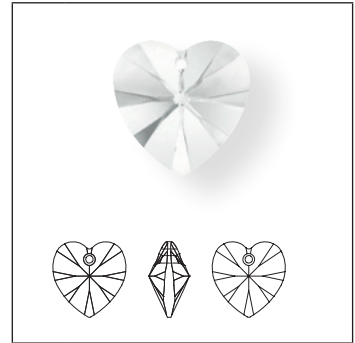

Size 10.3x10, 14.4x14, 18x17.5, 28 mm

6428 XILION Pendant

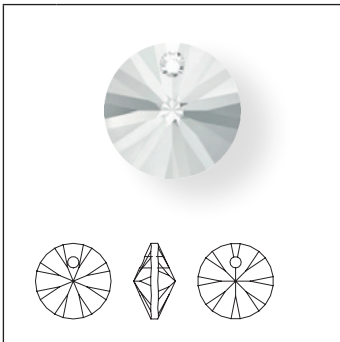

Size 6 mm

6428 XILION Pendant

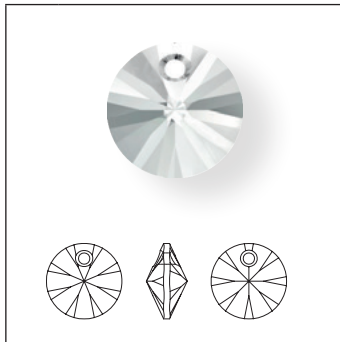

Size 8, 12 mm

	6010 Briolette Pendant				6106 Pear-shaped Pendant				6228 XILION Heart Pendant				6428 XILION Pendant			
	11x5.5 mm	13x6.5 mm	17x8.5 mm	21x10.5 mm	16 mm	22 mm	28 mm	38 mm	10.3x10 mm	14.4x14 mm	18x17.5 mm	28 mm	40 mm	6 mm	8 mm	12 mm
Crystal																
Crystal (001)	■	■	■	■	■	■	■	■	■	■	■	■	■	■	■	■
Colors																
Plain Colors																
Amethyst (204)	■	■	■		■	■	■		■	■	■		■	■	■	
Aquamarine (202)	■	■	■		■	■	■		■	■	■		■	■	■	
Blue Zircon (229)	■	■			■	■			■	■			■	■		
Denim Blue (266)	■	■														
Citrus Green (337)																
Emerald (205)	■	■	■		■	■	■		■	■	■		■	■	■	

* All colors with a 4-digit color code (i.e. Golden Topaz) are fully customizable with shorter lead times and lower MOQs compared to our 3-digit colors. Please get in touch with the Customer Service for a time and quantity estimation of your desired variant.

<p>6010 6106 6228 6428</p>		Size	6010 Briolette Pendant	6106 Pear-shaped Pendant	6228 XILION Heart Pendant	6428 XILION Pendant												
			11x5.5 mm	13x6.5 mm	17x8.5 mm	21x10.5 mm	16 mm	22 mm	28 mm	38 mm	10.3x10 mm	14.4x14 mm	18x17.5 mm	28 mm	40 mm	6 mm	8 mm	12 mm
Erinite (360)			■	■														
Fern Green (291)			■	■														
Fuchsia (502)			■	■							■	■						
Golden Topaz (1003)*			■	■				■	■		■	■				■	■	
Iris (219)			■	■												■	■	■
Jet (280)			■	■				■	■	■						■	■	■
Light Amethyst (212)			■	■				■	■		■	■	■			■	■	
Light Colorado Topaz (246)			■	■				■	■	■						■	■	■
Light Rose (223)			■	■	■			■	■	■		■	■	■		■	■	■
Light Sapphire (211)								■	■									
Light Siam (227)								■			■	■	■			■	■	
Light Topaz (226)			■	■							■	■						
Light Turquoise (263)			■	■												■	■	
Padparadscha (542)			■	■														
Peridot (214)			■	■				■	■		■	■				■	■	
Rose (209)			■	■					■		■	■	■			■	■	
Rose Peach (262)			■	■				■										
Ruby (501)								■	■									
Sapphire (206)			■	■				■	■		■	■				■	■	
Scarlet (276)			■	■	■			■	■	■	■	■	■			■	■	■
Siam (208)			■	■							■	■	■			■	■	
Smoked Amber (1001)*			■	■				■	■		■	■						
Tanzanite (539)			■	■	■			■	■									
Violet (371)											■	■				■	■	
Crystal Effects																		
Transparent Effects																		
Crystal AB (001 AB)			■	■	■	■		■	■	■	■	■	■	■	■	■	■	■
Crystal Antique Pink (001 ANTP)								■	■							■	■	
Crystal Bermuda Blue (001 BB)											■	■	■					
Crystal Bermuda Blue P (001 BB) ¹													■					
Crystal Blue Shade (001 BLSH)			■	■				■	■							■	■	
Crystal Golden Shadow (001 GSHA)			■	■	■	■		■	■	■	■	■	■			■	■	
Crystal Heliotrope (001 HEL)											■	■	■					
Crystal Paradise Shine (001 PARSH)			■	■				■	■		■	■	■			■	■	
Crystal Shimmer (001 SHIM)								■	■	■	■	■	■			■	■	
Crystal Silver Night (001 SINI)			■	■				■	■	■	■	■	■	■		■	■	

* All colors with a 4-digit color code (i.e. Golden Topaz) are fully customizable with shorter lead times and lower MOQs compared to our 3-digit colors. Please get in touch with the Customer Service for a time and quantity estimation of your desired variant.

6010 6106 6228 6428		Size	6010 Briolette Pendant	6106 Pear-shaped Pendant	6228 XILION Heart Pendant	6428 XILION Pendant
			11x5.5 mm	16 mm	10.3x10 mm	6 mm
			13x6.5 mm	22 mm	14.4x14 mm	8 mm
			17x8.5 mm	28 mm	18x17.5 mm	12 mm
			21x10.5 mm	38 mm	28 mm	
					40 mm	
Crystal Silver Shade (001 SSHA)			■	■		■
Crystal Vitrail Light (001 VL)					■	■
Crystal Vitrail Medium (001 VM)					■	■
Color Effects						
Transparent Effects						
Amethyst Shimmer (204 SHIM)			■	■	■	■
Aquamarine AB (202 AB)					■	■
Aquamarine Shimmer (202 SHIM)			■	■	■	■
Blue Zircon AB (229 AB)					■	
Emerald Shimmer (205 SHIM)			■	■		
Fuchsia AB (502 AB)					■	
Light Amethyst Shimmer (212 SHIM)			■	■	■	■
Light Colorado Topaz Shimmer (246 SHIM)			■	■		
Light Rose AB (223 AB)					■	■
Light Rose Shimmer (223 SHIM)			■	■	■	■
Light Sapphire Shimmer (211 SHIM)			■	■		
Light Siam AB (227 AB)					■	
Light Siam Shimmer (227 SHIM)					■	■
Light Topaz AB (226 AB)					■	
Light Topaz Shimmer (226 SHIM)					■	
Peridot AB (214 AB)					■	
Rose AB (209 AB)					■	■
Sapphire AB (206 AB)					■	
Siam AB (208 AB)					■	■
Violet AB (371 AB)					■	

6015 Polygon Drop

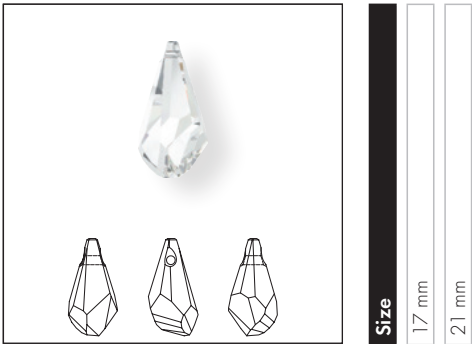

Crystal

Crystal (001)

Crystal Effects

Transparent Effects

Crystal Aurore Boreale (001 AB)

Crystal Golden Shadow (001 GSHA)

Maison Margiela for Swarovski

CRYSTALACTITE PENDANTS

Since 1988, Paris-based Maison Margiela has become famous for its collaborative team-led approach and its avant-garde transformation of classic designs. In July 2013, it presented the Maison Margiela Crystalactite for Swarovski at its Paris Haute Couture show. These were groundbreaking Crystal Fusion components inspired by natural stalactite forms and developed in creative partnership with Swarovski. Swarovski presents its interpretation of this innovative cut in pure crystalline form – the Crystalactite Pendant. Featuring a progressive

aesthetic combining partly frosted facets with primeval, irregular icicle shapes, the vision that originated in our wildest landscapes has been perfected by one of the most sophisticated design houses. With an easy-to-use hole at the top, the Pendant offers myriad design possibilities for strong, contemporary designs, and for recreating haute-couture looks.

“Naturally and spontaneously, an imposing crystal emerges from its raw, stony origin, patiently growing into its iconic stalactite shape.”

6017/G Crystalactite Pendant grand partly frosted

	Size	30 mm	56 mm
Crystal			
Crystal (001)		■	■
Crystal Effects			
Transparent Effects			
Crystal Aurore Boreale V (001 ABV)		■	■
Crystal Bermuda Blue P (001 BB)		■	■
Crystal Golden Shadow V (001 GSHAV)		■	■
Crystal Vitrail Medium P (001 VM)		■	■

6020 Helix Pendant



Size
18 mm
30 mm
37 mm

- Crystal**
- Crystal (001)
- Crystal Effects**
- Transparent Effects**
- Crystal Aurore Boreale (001 AB)
- Crystal Golden Shadow (001 GSHA)

6022 XIRIUS Raindrop Pendant

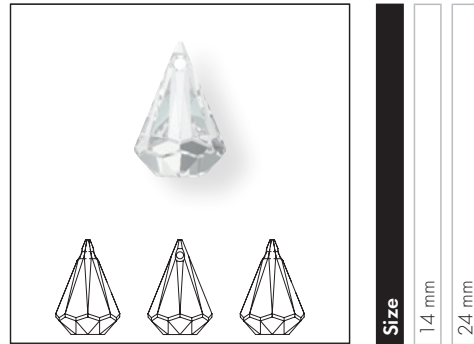

Size
14 mm
24 mm

- Crystal**
- Crystal (001)
- Crystal Effects**
- Transparent Effects**
- Crystal Aurore Boreale (001 AB)

6028 XILION Oval Pendant

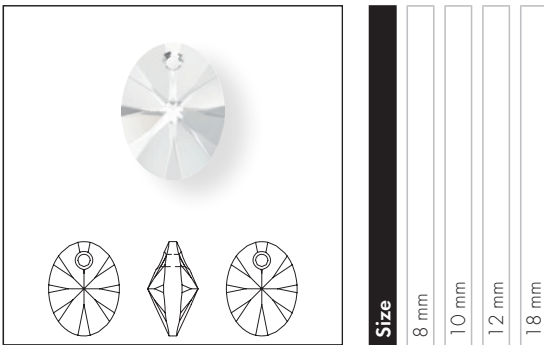

Size
8 mm
10 mm
12 mm
18 mm

- Crystal**
- Crystal (001)
- Crystal Effects**
- Transparent Effects**
- Crystal Aurore Boreale (001 AB)
- Crystal Silver Night (001 SINI)
- Crystal Vitrail Light P (001 VL)

6040 Helios Pendant

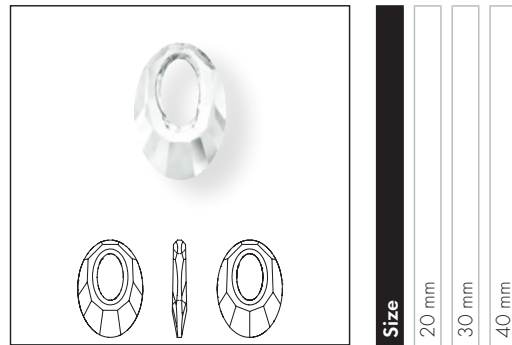

Size
20 mm
30 mm
40 mm

- Crystal**
- Crystal (001)
- Crystal Effects**
- Transparent Effects**
- Crystal Aurore Boreale (001 AB)
- Crystal Silver Night (001 SINI)

6049 Flat Disc Pendant

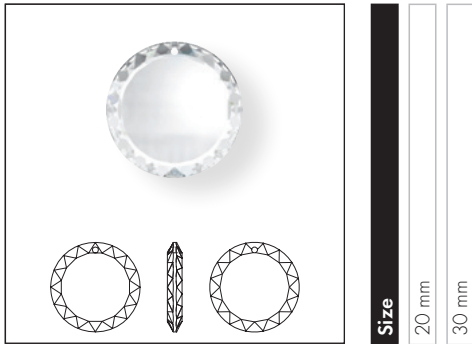

Size
20 mm
30 mm

Crystal

Crystal (001)

6090 Baroque Pendant

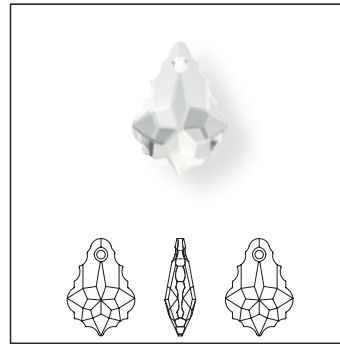

Size
16x11 mm
22x15 mm

Crystal

Crystal (001)

Colors

Plain Colors

Jet (280)

Ruby (501)

Crystal Effects

Transparent Effects

Crystal Aurore Boreale (001 AB)

Crystal Bermuda Blue (001 BB)

Crystal Golden Shadow (001 GSHA)

Crystal Vitrail Light (001 VL)

6100 Elegant Pendant

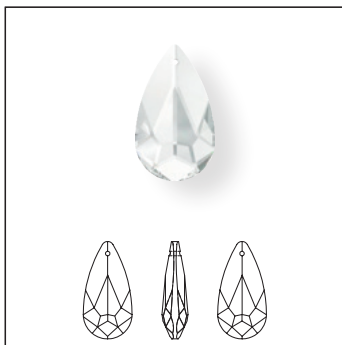

Size
24x12 mm

Crystal

Crystal (001)

Crystal Effects

Transparent Effects

Crystal Aurore Boreale (001 AB)

Crystal Bermuda Blue (001 BB)

Crystal Vitrail Light (001 VL)

Crystal Vitrail Medium (001 VM)

6128 XILLION Mini Pear Pendant

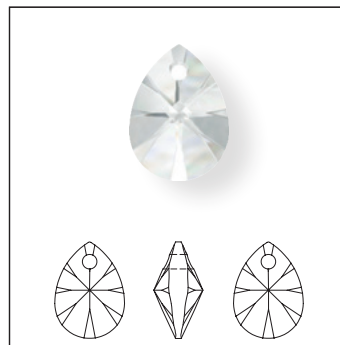

Size
8 mm
10 mm
12 mm

Crystal

Crystal (001)

Crystal Effects

Transparent Effects

Crystal Aurore Boreale (001 AB)

Crystal Golden Shadow (001 GSHA)

Crystal Paradise Shine (001 PARSH)

6210 Lunar Pendant

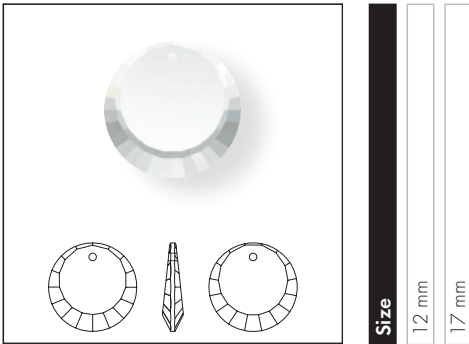

Size
12 mm
17 mm

Crystal

Crystal (001)

Crystal Effects

Transparent Effects

Crystal Aurore Boreale (001 AB)

6215 Classic Heart Pendant

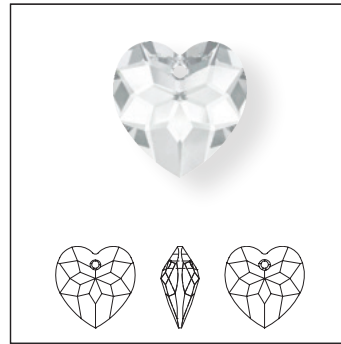

Size
18 mm

Crystal

Crystal (001)

Crystal Effects

Transparent Effects

Crystal Aurore Boreale (001 AB)

Crystal Bermuda Blue P (001 BB)

Crystal Vitrail Light (001 VL)

6225 Flat Heart Pendant

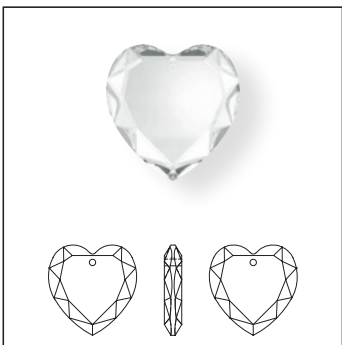

Size
10 mm
18 mm
28 mm

Crystal

Crystal (001)

6240 Wild Heart Pendant



Size
12 mm
17 mm
27 mm

Crystal

Crystal (001)

Crystal Effects

Transparent Effects

Crystal Aurore Boreale (001 AB)

”Love Story of the Heart“ by Manish Arora

Since the beginning of his international career, the award-winning, Delhi-based designer Manish Arora has worked creatively with Swarovski. In 2009, he created a memorable collection of crystalline Transfers. One year later, India's best-loved and most prolific design talent renewed his partnership with Swarovski and created a special collection of heart-shaped Pendants, which were launched in February 2011. Each individual piece is an expression of love's different emotional states and is named accordingly.



The partnership with Manish Arora is symbolic of how Swarovski engages in mutually rewarding creative partnerships with the world's best and brightest design spirits.

“The heart shape is very close to me because it is the universal symbol of love. I wanted to bring this symbol to life by creating a collection of crystal pendants and I hope people will wear them as a personal expression of the beauty and purity of this emotion.” Manish Arora

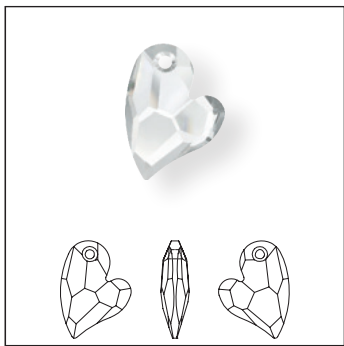
6261 Devoted 2 U Heart





Size	17 mm	27 mm
------	-------	-------

Crystal	
 Crystal (001)	
Crystal Effects	
Transparent Effects	
 Crystal Aurore Boreale (001 AB)	

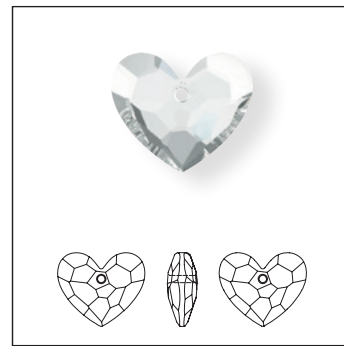
6264 Truly in Love Heart



Size	18 mm	28 mm
------	-------	-------

Crystal	
 Crystal (001)	
Crystal Effects	
Transparent Effects	
 Crystal Aurore Boreale (001 AB)	
 Crystal Bermuda Blue P (001 BB)	

6328 XILION Bi-Cone Pendant

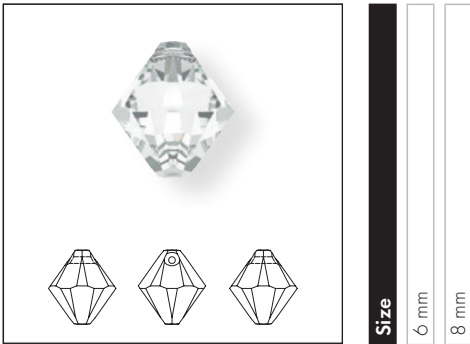

Size
6 mm
8 mm

- Crystal**
- Crystal (001)
- Colors**
- Plain Colors**
- Aquamarine (202)
- Light Rose (223)
- Violet (371)
- Crystal Effects**
- Transparent Effects**
- Crystal Aurore Boreale (001 AB)
- Crystal Golden Shadow (001 GSHA)

6401 Octagon Pendant

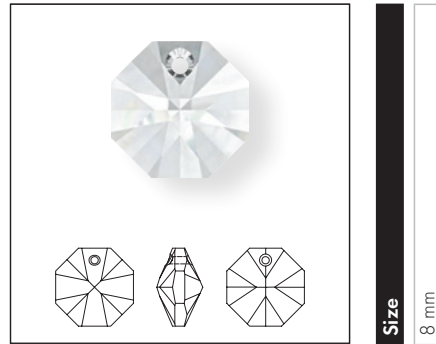

Size
8 mm

- Crystal**
- Crystal (001)
- Crystal Effects**
- Transparent Effects**
- Crystal Aurore Boreale (001 AB)
- Crystal Golden Shadow (001 GSHA)
- Crystal Silver Shade (001 SSHA)

6430 Classic Cut Pendant



Crystal	8 mm	10 mm	14 mm
Crystal (001)	■	■	■
Colors			
Plain Colors			
Amethyst (204)	■	■	■
Aquamarine (202)	■	■	■
Blue Zircon (229)	■	■	■
Emerald (205)	■	■	■
Light Amethyst (212)	■	■	■
Montana (207)	■	■	■
Peridot (214)	■	■	■
Rose (209)	■	■	■
Sapphire (206)	■	■	■
Scarlet (276)	■	■	■
Siam (208)	■	■	■
Crystal Effects			
Transparent Effects			
Crystal Aurore Boreale (001 AB)	■	■	■
Crystal Bermuda Blue P (001 BB)	■	■	■
Crystal Golden Shadow (001 GSHA)	■	■	■
Crystal Shimmer (001 SHIM)	■	■	■
Crystal Silver Night (001 SINI)	■	■	■
Crystal Vitrail Light P (001 VL)	■	■	■
Crystal Vitrail Medium P (001 VM)	■	■	■
Color Effects			
Transparent Effects			
Aquamarine Shimmer (202 SHIM)	■	■	■
Light Rose Shimmer (223 SHIM)	■	■	■

6431 Princess Cut Pendant

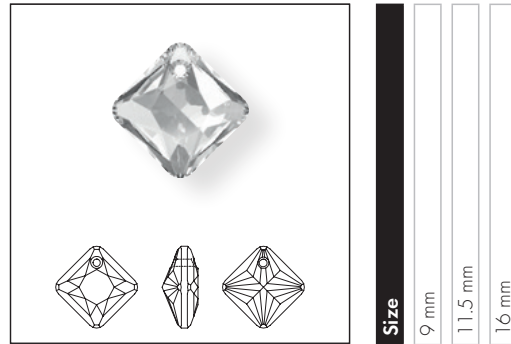

Crystal	9 mm	11.5 mm	16 mm
Crystal (001)	■	■	■
Crystal Effects			
Transparent Effects			
Crystal Aurore Boreale (001 AB)	■	■	■
Crystal Bermuda Blue P (001 BB)	■	■	■
Crystal Golden Shadow (001 GSHA)	■	■	■
Crystal Shimmer (001 SHIM)	■	■	■
Crystal Silver Night (001 SINI)	■	■	■
Crystal Vitrail Light P (001 VL)	■	■	■
Crystal Vitrail Medium P (001 VM)	■	■	■

6432 Heart Cut Pendant

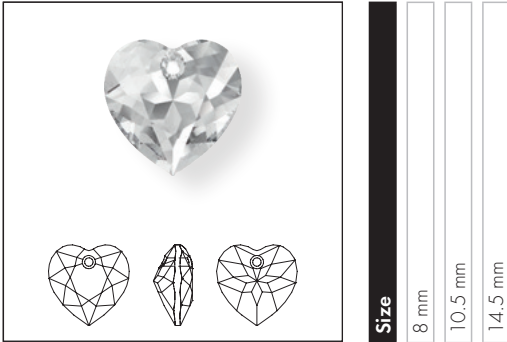

Crystal	8 mm	10.5 mm	14.5 mm
Crystal (001)	■	■	■
Colors			
Plain Colors			
Amethyst (204)	■	■	■
Aquamarine (202)	■	■	■
Light Rose (223)	■	■	■
Light Siam (227)	■	■	■
Montana (207)	■	■	■
Rose (209)	■	■	■
Scarlet (276)	■	■	■
Siam (208)	■	■	■
Crystal Effects			
Transparent Effects			
Crystal Aurore Boreale (001 AB)	■	■	■
Crystal Bermuda Blue P (001 BB)	■	■	■
Crystal Golden Shadow (001 GSHA)	■	■	■
Crystal Shimmer (001 SHIM)	■	■	■
Crystal Silver Night (001 SINI)	■	■	■
Crystal Vitrail Light P (001 VL)	■	■	■
Crystal Vitrail Medium P (001 VM)	■	■	■
Color Effects			
Transparent Effects			
Aquamarine Shimmer (202 SHIM)	■	■	■
Light Rose Shimmer (223 SHIM)	■	■	■

6433 Pear Cut Pendant

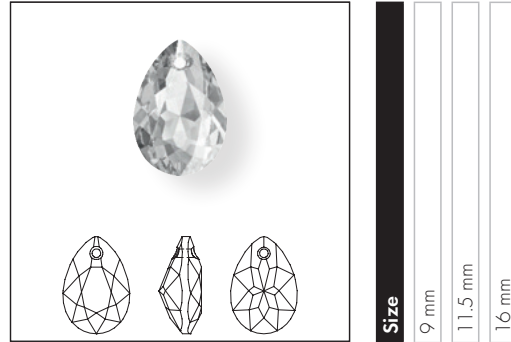

Crystal	9 mm	11.5 mm	16 mm
Crystal (001)	■	■	■
Crystal Effects			
Transparent Effects			
Crystal Aurore Boreale (001 AB)	■	■	■
Crystal Bermuda Blue P (001 BB)	■	■	■
Crystal Golden Shadow (001 GSHA)	■	■	■
Crystal Shimmer (001 SHIM)	■	■	■
Crystal Silver Night (001 SINI)	■	■	■
Crystal Vitrail Light P (001 VL)	■	■	■
Crystal Vitrail Medium P (001 VM)	■	■	■
Color Effects			
Transparent Effects			
Amethyst Shimmer (204 SHIM)	■	■	■
Aquamarine Shimmer (202 SHIM)	■	■	■
Emerald Shimmer (205 SHIM)	■	■	■
Light Rose Shimmer (223 SHIM)	■	■	■

6434 Trilliant Cut Pendant



Crystal		8 mm	10.5 mm	14.5 mm
Crystal (001)		■	■	■
Colors				
Plain Colors				
Amethyst (204)		■	■	■
Aquamarine (202)		■	■	■
Blue Zircon (229)		■	■	■
Citrus Green (337)		■	■	■
Emerald (205)		■	■	■
Golden Topaz (1003)		■	■	■
Light Amber (1002)		■	■	■
Light Amethyst (212)		■	■	■
Light Rose (223)		■	■	■
Light Siam (227)		■	■	■
Peridot (214)		■	■	■
Rose (209)		■	■	■
Sapphire (206)		■	■	■
Scarlet (276)		■	■	■
Siam (208)		■	■	■
Crystal Effects				
Transparent Effects				
Crystal Aurore Boreale (001 AB)		■	■	■
Crystal Bermuda Blue P (001 BB)		■	■	■
Crystal Golden Shadow (001 GSHA)		■	■	■
Crystal Shimmer (001 SHIM)		■	■	■
Crystal Silver Night (001 SINI)		■	■	■
Crystal Vitrail Light P (001 VL)		■	■	■
Crystal Vitrail Medium P (001 VM)		■	■	■

6435 Emerald Cut Pendant

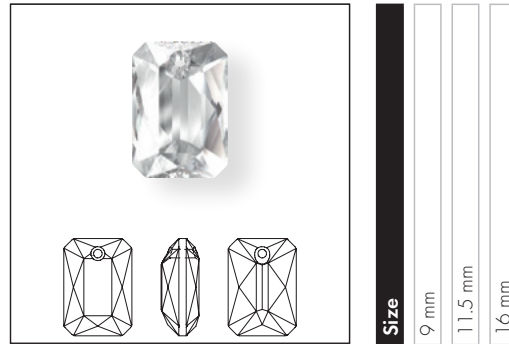

Crystal		9 mm	11.5 mm	16 mm
Crystal (001)		■	■	■
Crystal Effects				
Transparent Effects				
Crystal Aurore Boreale (001 AB)		■	■	■
Crystal Bermuda Blue P (001 BB)		■	■	■
Crystal Golden Shadow (001 GSHA)		■	■	■
Crystal Shimmer (001 SHIM)		■	■	■
Crystal Silver Night (001 SINI)		■	■	■
Crystal Vitrail Light P (001 VL)		■	■	■
Crystal Vitrail Medium P (001 VM)		■	■	■

6436 Majestic Pendant



Size	9 mm	11.5 mm	16 mm
------	------	---------	-------

Crystal

Crystal (001)

Colors

Plain Colors

Amethyst (204)

Aquamarine (202)

Blue Zircon (229)

Citrus Green (337)

Emerald (205)

Golden Topaz (1003)

Jonquil (213)

Light Amber (1002)

Light Amethyst (212)

Light Rose (223)

Peridot (214)

Rose (209)

Sapphire (206)

Scarlet (276)

Siam (208)

Crystal Effects

Transparent Effects

Crystal Aurore Boreale (001 AB)

Crystal Bermuda Blue P (001 BB)

Crystal Golden Shadow (001 GSHA)

Crystal Shimmer (001 SHIM)

Crystal Silver Night (001 SINI)

Crystal Vitrail Light P (001 VL)

Crystal Vitrail Medium P (001 VM)

Crystal (001)	■	■	■
Amethyst (204)	■	■	■
Aquamarine (202)	■	■	■
Blue Zircon (229)	■	■	■
Citrus Green (337)	■	■	■
Emerald (205)	■	■	■
Golden Topaz (1003)	■	■	■
Jonquil (213)	■	■	■
Light Amber (1002)	■	■	■
Light Amethyst (212)	■	■	■
Light Rose (223)	■	■	■
Peridot (214)	■	■	■
Rose (209)	■	■	■
Sapphire (206)	■	■	■
Scarlet (276)	■	■	■
Siam (208)	■	■	■
Crystal Aurore Boreale (001 AB)		■	■
Crystal Bermuda Blue P (001 BB)	■	■	■
Crystal Golden Shadow (001 GSHA)		■	■
Crystal Shimmer (001 SHIM)		■	■
Crystal Silver Night (001 SINI)		■	■
Crystal Vitrail Light P (001 VL)	■	■	■
Crystal Vitrail Medium P (001 VM)	■	■	■

6438 Elliptic Cut Pendant



Size 9 mm

6438 Elliptic Cut Pendant



Size 11.5, 16 mm

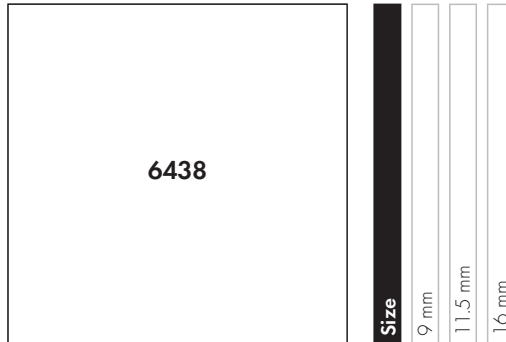

	9 mm	11.5 mm	16 mm
Crystal			
Crystal (001)	■	■	■
Colors			
Plain Colors			
Amethyst (204)	■	■	■
Aquamarine (202)	■	■	■
Blue Zircon (229)	■	■	■
Emerald (205)	■	■	■
Light Amethyst (212)	■	■	■
Light Rose (223)	■	■	■
Peridot (214)	■	■	■
Rose (209)	■	■	■
Sapphire (206)	■	■	■
Scarlet (276)	■	■	■
Topaz (203)	■	■	■
Crystal Effects			
Transparent Effects			
Crystal Aurore Boreale (001 AB)	■	■	■
Crystal Bermuda Blue P (001 BB)	■	■	■
Crystal Golden Shadow (001 GSHA)	■	■	■
Crystal Shimmer (001 SHIM)	■	■	■
Crystal Silver Night (001 SINI)	■	■	■
Crystal Vitrail Light P (001 VL)	■	■	■
Crystal Vitrail Medium P (001 VM)	■	■	■

6460 Column Pendant

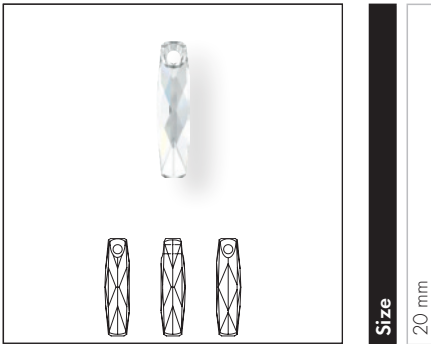

Size
20 mm

Crystal

Crystal (001)

Crystal Effects

Transparent Effects

Crystal Aurore Boreale (001 AB)

Crystal Silver Shade (001 SSHA)

6480 Spike Pendant

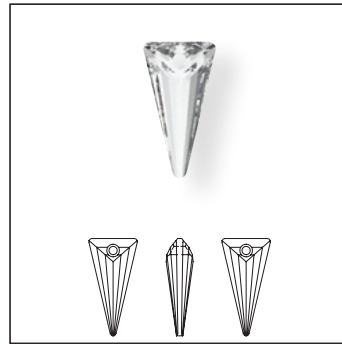

Size
18 mm
28 mm
39 mm

Crystal

Crystal (001)

Colors

Plain Colors

Jet (280)

Crystal Effects

Transparent Effects

Crystal Aurore Boreale (001 AB)

Crystal Bermuda Blue P (001 BB)

Crystal Blue Shade (001 BLSH)

Crystal Golden Shadow (001 GSHA)

Crystal Silver Night (001 SINI)

Crystal Vitrail Medium P (001 VM)

6533 Raindrop Pendant

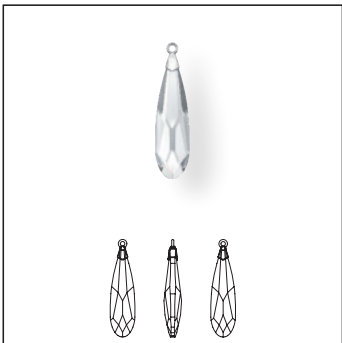

Size
17.5 mm Gold colored plating
17.5 mm Rhodium plating
23 mm Gold colored plating
23 mm Rhodium plating
33 mm Gold colored plating
33 mm Rhodium plating

Crystal

Crystal (001)

Crystal Effects

Transparent Effects

Crystal Bermuda Blue (001 BB)

Crystal Golden Shadow (001 GSHA)

6565 Metallic Cap Pear-shaped Pendant



Size
18 mm
22 mm

Crystal Effects

Metallic Effects

Crystal & Light Chrome Z MCI (001 LTCHZ)

Color Effects

Metallic Effects

Aquamarine & Light Chrome Z MCI (202 LTCHZ)

6628 XILION Triangle Pendant

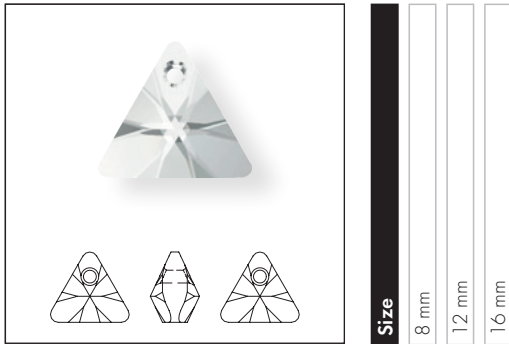

Size
8 mm
12 mm
16 mm

Crystal

Crystal (001)

Crystal Effects

Transparent Effects

- Crystal Aurore Boreale (001 AB)
- Crystal Bermuda Blue P (001 BB)
- Crystal Silver Night (001 SINI)
- Crystal Vitrail Light P (001 VL)

6656 Galactic Vertical Pendant

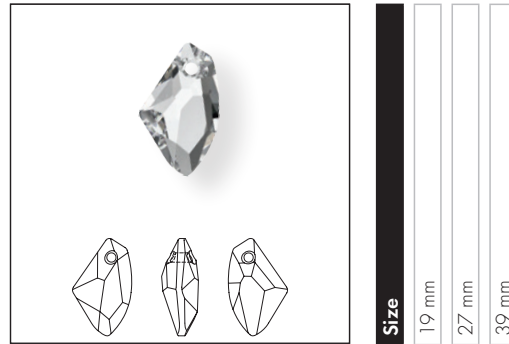

Size
19 mm
27 mm
39 mm

Crystal

Crystal (001)

Colors

Plain Colors

- Aquamarine (202)
- Light Rose (223)
- Peridot (214)
- Tanzanite (539)

Crystal Effects

Transparent Effects

- Crystal Bermuda Blue P (001 BB)
- Crystal Golden Shadow (001 GSHA)
- Crystal Moonlight (001 MOL)
- Crystal Silver Shade (001 SSHA)

6670 De-Art Pendant



Size
18 mm
24 mm
50 mm

Crystal

Crystal (001)

Colors

Plain Colors

Aquamarine (202)

Crystal Effects

Transparent Effects

- Crystal Aurore Boreale (001 AB)
- Crystal Bermuda Blue P (001 BB)
- Crystal Golden Shadow (001 GSHA)
- Crystal Silver Night (001 SINI)

6673 Meteor Pendant

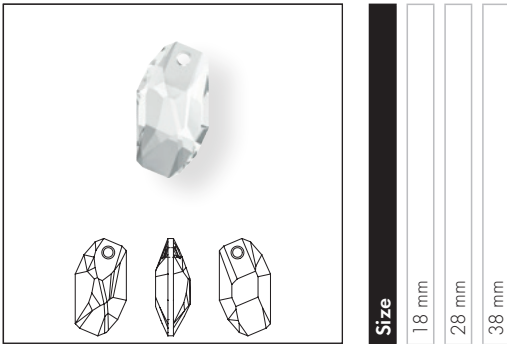

Size
18 mm
28 mm
38 mm

- Crystal**
- Crystal (001)
- Colors**
- Plain Colors**
- Light Turquoise (263)
- Crystal Effects**
- Transparent Effects**
- Crystal Aurore Boreale (001 AB)
- Crystal Golden Shadow (001 GSHA)

6680 Cosmic Pendant

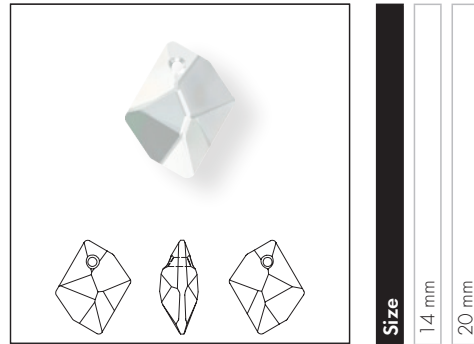

Size
14 mm
20 mm

- Crystal**
- Crystal (001)
- Crystal Effects**
- Transparent Effects**
- Crystal Aurore Boreale (001 AB)
- Crystal Golden Shadow (001 GSHA)

6685 Graphic Pendant

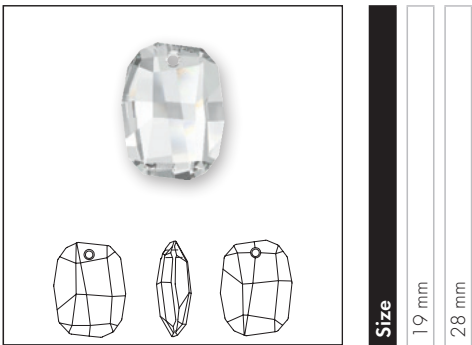

Size
19 mm
28 mm

- Crystal**
- Crystal (001)
- Colors**
- Plain Colors**
- Emerald (205)
- Crystal Effects**
- Transparent Effects**
- Crystal Aurore Boreale (001 AB)
- Crystal Golden Shadow (001 GSHA)

6690 Wing Pendant

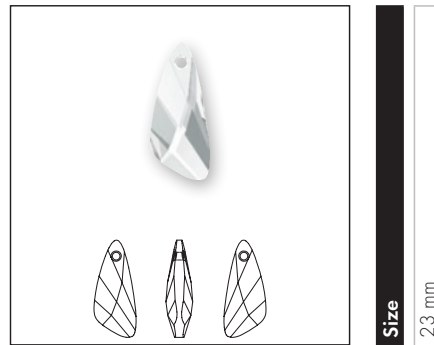

Size
23 mm

- Crystal**
- Crystal (001)
- Colors**
- Plain Colors**
- Capri Blue (243)
- Crystal Effects**
- Transparent Effects**
- Crystal Aurore Boreale (001 AB)
- Crystal Silver Night (001 SINI)

6696 Urban Pendant

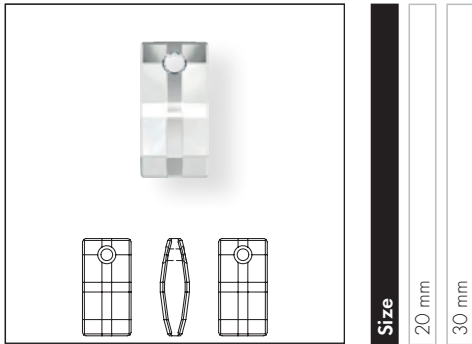

Size
20 mm
30 mm

Crystal

Crystal (001)

Crystal Effects

Transparent Effects

Crystal Aurore Boreale (001 AB)

Crystal Bermuda Blue P (001 BB)

Crystal Silver Night (001 SINI)

6704 Snowflake Pendant

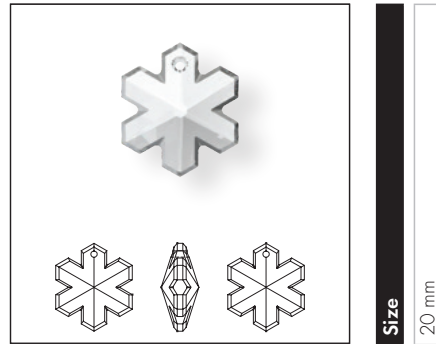

Size
20 mm

Crystal

Crystal (001)

Crystal Effects

Transparent Effects

Crystal Aurore Boreale (001 AB)

6714 Star Pendant

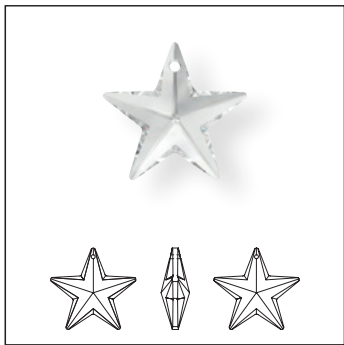

Size
20 mm
28 mm
40 mm

Crystal

Crystal (001)

Crystal Effects

Transparent Effects

Crystal Aurore Boreale (001 AB)

6721 Starfish Pendant

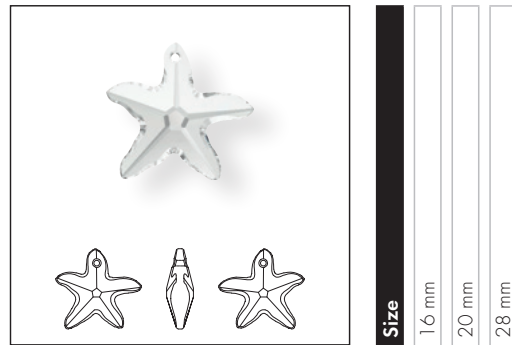

Size
16 mm
20 mm
28 mm

Crystal

Crystal (001)

Crystal Effects

Transparent Effects

Crystal Aurore Boreale (001 AB)

Crystal Bermuda Blue P (001 BB)

Ocean Mysteries designed by Céline Cousteau

Design Story: A love for the sea runs through her veins: Céline Cousteau is a celebrated filmmaker, humanitarian, and environmentalist, as well as the granddaughter of legendary ocean explorer Jacques-Yves Cousteau. She presents her first ever designs made of crystals for Swarovski, inspired by one of her favorite places, the depths of the ocean. Taking inspiration from nature itself

and leaving its beauty unaltered, her stunningly life-like creatures are not only captivating and spellbinding, they also draw attention toward the mysterious, mostly unseen, and unexplored world beneath the ocean's surface on which all ocean life depends. These mysteries need to be protected for future generations, both above and below the water.

6731 Sea Snail Pendant partly frosted

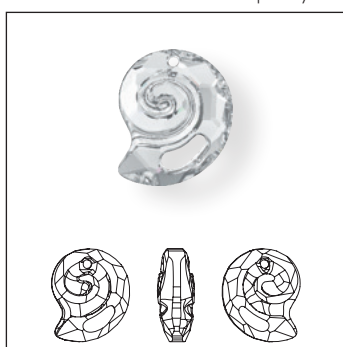

Size 14 mm

6731 Sea Snail Pendant partly frosted



Size 28 mm

6731

Crystal	Crystal (001)		
Crystal Effects			
Transparent Effects			
	Crystal Aurore Boreale (001 AB)		

Size

14 mm

28 mm

6735 Leaf Pendant

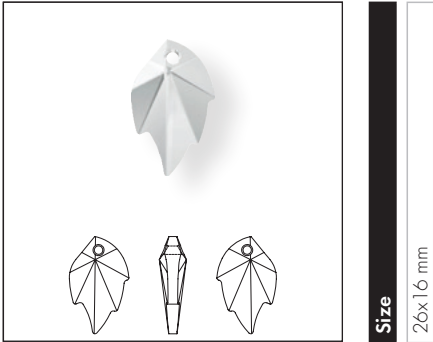

Size
26x16 mm

- Crystal**
- Crystal (001)
- Colors**
- Plain Colors**
- Emerald (205)
- Crystal Effects**
- Transparent Effects**
- Crystal Aurore Boreale (001 AB)
- Crystal Golden Shadow (001 GSHA)

6744 Flower Pendant

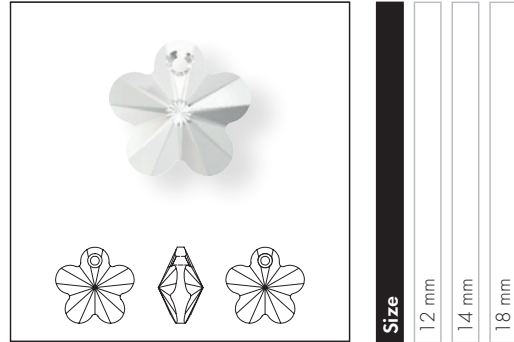

Size
12 mm
14 mm
18 mm

- Crystal**
- Crystal (001)
- Crystal Effects**
- Transparent Effects**
- Crystal Aurore Boreale (001 AB)

6748 Edelweiss Pendant

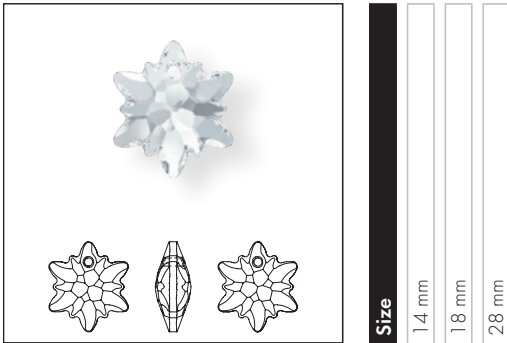

Size
14 mm
18 mm
28 mm

- Crystal**
- Crystal (001)
- Crystal Effects**
- Transparent Effects**
- Crystal Aurore Boreale (001 AB)

6864 Cross Pendant

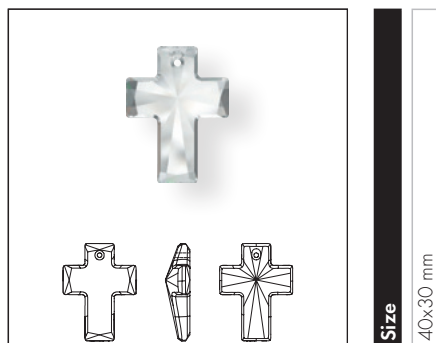

Size

40x30 mm

Crystal

Crystal (001)

Crystal Effects

Transparent Effects

Crystal Aurore Boreale V (001 ABV)

6866 Square Cross Pendant



Size

20 mm

Crystal

Crystal (001)

Crystal Effects

Transparent Effects

Crystal Aurore Boreale (001 AB)

Product Details

Product Details

Article Size	Packing Unit = Minimum Order Quantity in Pieces	Average Net Weight in Gram per Packing Unit Crystal (001)	Average Gross Weight in Gram per Packing Unit Crystal (001)
6000			
11x5.5 mm	288	99.8	123.1
13x6.5 mm	288	156.9	197.5
15x7.5 mm	144	129.8	153.4
22x11 mm	48	129.4	151.3
6002			
10x7 mm	144	91.4	109.3
15x11.5 mm	72	175.4	197.3
6007			
7x4 mm	360	46.7	55.8
9x5 mm	288	77.1	104.2
6010			
11x5.5 mm	144	57.4	75.9
13x6.5 mm	144	91.1	109.0
17x8.5 mm	36	57.3	77.2
21x10.5 mm	24	66.3	83.4
6015			
17 mm	72	93.2	111.5
21 mm	48	105.9	129.3
6017/G			
30 mm	12	25.0	45.6
56 mm	6	67.5	91.4
6020			
18 mm	36	49.7	72.1
30 mm	12	74.3	95.5
37 mm	6	76.4	82.5
6022			
14 mm	72	77.2	97.0
24 mm	24	133.9	155.5
6028			
8 mm	144	31.8	40.9
10 mm	192	71.0	97.7
12 mm	108	68.9	92.9
18 mm	72	146.5	170.3
6040			
20 mm	72	66.3	92.8
30 mm	30	85.4	116.4
40 mm	6	41.7	61.4
6049			
20 mm	72	170.5	200.4
30 mm	24	166.7	209.2
6090			
16x11 mm	72	55.8	75.8
22x15 mm	48	102.2	136.7
6100			
24x12 mm	36	54.5	83.9

Article Size	Packing Unit = Minimum Order Quantity in Pieces	Average Net Weight in Gram per Packing Unit Crystal (001)	Average Gross Weight in Gram per Packing Unit Crystal (001)
6106			
16 mm	144	129.9	158.3
22 mm	96	208.1	248.5
28 mm	36	171.8	201.1
38 mm	9	91.1	121.6
6128			
8 mm	144	23.2	34.0
10 mm	144	52.3	80.0
12 mm	144	81.8	101.3
6210			
12 mm	144	67.8	90.9
17 mm	72	98.8	122.0
6215			
18 mm	72	183.2	210.5
6225			
10 mm	144	48.3	68.4
18 mm	24	41.6	59.0
28 mm	24	160.7	206.2
6228			
10.3x10 mm	288	124.6	152.6
14.4x14 mm	144	181.4	210.5
18x17.5 mm	72	188.0	211.7
28 mm	16	124.0	158.7
40 mm	6	155.2	182.9
6240			
12 mm	108	63.3	83.5
17 mm	72	116.4	137.0
27 mm	24	142.6	147.8
6261			
17 mm	48	48.2	76.6
27 mm	20	77.0	102.6
6264			
18 mm	48	93.4	109.1
28 mm	16	93.7	118.2
6328			
6 mm	360	78.5	89.5
8 mm	288	153.2	173.2
6401			
8 mm	288	106.8	123.8
6428			
6 mm	720	80.1	89.5
8 mm	144	37.4	46.7
12 mm	144	121.8	141.6
6430			
8 mm	72	23.7	42.1
10 mm	48	31.7	51.9
14 mm	24	40.9	61.6

Article Size	Packing Unit = Minimum Order Quantity in Pieces	Average Net Weight in Gram per Packing Unit Crystal (001)	Average Gross Weight in Gram per Packing Unit Crystal (001)
6431			
9 mm	72	22.1	40.5
11.5 mm	48	30.1	51.1
16 mm	24	41,9	62.6
6432			
8 mm	72	21.9	40.3
10.5 mm	48	31.6	51.8
14.5 mm	24	40.0	60.7
6433			
9 mm	72	18.1	33.2
11.5 mm	48	28.8	46.1
16 mm	36	54.0	71.9
6434			
8 mm	72	20.1	40.3
10.5 mm	48	30.5	51.1
14.5 mm	24	38.5	59.2
6435			
9 mm	72	24.2	42.8
11.5 mm	48	35.1	53.7
16 mm	24	46.1	64.7
6436			
9 mm	72	26.9	45.3
11.5 mm	48	30.9	51.1
16 mm	24	47.4	65.8
6438			
9 mm	72	18.7	38.9
11.5 mm	48	28.3	48.5
16 mm	36	53.3	73.5
6460			
20 mm	72	60.3	83.1
6480			
18 mm	48	42.7	64.1
28 mm	36	101.6	130.5
39 mm	16	105.6	133.7
6533			
17.5 mm	36	11.6	31.8
23 mm	24	14.6	35.4
33 mm	12	22.7	43.4
6565			
18 mm	36	43.6	64.2
22 mm	24	54.9	75.0
6628			
8 mm	288	72.6	72.8
12 mm	144	101.6	126.9
16 mm	72	128.2	155.1
6656			
19 mm	48	72.3	94.2
27 mm	30	126.1	159.6
39 mm	6	61.8	82.0

Article Size	Packing Unit = Minimum Order Quantity in Pieces	Average Net Weight in Gram per Packing Unit Crystal (001)	Average Gross Weight in Gram per Packing Unit Crystal (001)
6670			
18 mm	72	68.4	104.6
24 mm	48	105.5	161.9
50 mm	6	104.7	126.8
6673			
18 mm	48	59.7	80.7
28 mm	20	89.0	112.2
38 mm	6	69.5	87.1
6680			
14 mm	144	118.7	145.1
20 mm	72	167.5	191.1
6685			
19 mm	48	104.5	127.4
28 mm	24	168.7	175.4
6690			
23 mm	36	54.5	88.6
6696			
20 mm	24	53.5	70.6
30 mm	10	59.6	83.3
6704			
20 mm	48	131.4	155.0
6714			
20 mm	48	48.2	73.1
28 mm	24	112.5	156.1
40 mm	6	56.1	87.4
6721			
16 mm	72	105.1	131.7
20 mm	30	76.8	113.6
28 mm	12	66.3	93.7
6731			
14 mm	36	35.1	64.0
28 mm	8	76.4	98.2
6735			
26x16 mm	30	73.3	110.0
6744			
12 mm	144	118.7	145.4
14 mm	144	172.9	204.5
18 mm	72	174.8	207.2
6748			
14 mm	72	65.3	90.0
18 mm	48	88.3	110.2
28 mm	18	115.7	145.4
6864			
40x30 mm	9	109.2	142.2
6866			
20 mm	72	249.5	272.8