

Beads

Swarovski Beads set the benchmark for excellence in the market. Meticulously crafted, precision-cut with a clear hole, and extraordinary brilliance, the rounded edge of the hole reduces the wear on threads to increase design durability. Available in a wide range of shapes and cuts, from classically elegant through to playful and modern, they offer myriad creative possibilities.

With a large assortment of vibrant colors, and effects they are predominantly applied using beading, wiring, stringing and weaving. Various hole diameters open up new, unlimited application, and design possibilities, particularly for apparel and accessories embellishment.



Colors & Effects

OPEN TO SEE COLORS & EFFECTS















Colors

 Crystal 001	 Light Sapphire 211
 White Opal 234	 Sapphire 206
 Light Silk 261	 Capri Blue 243
 Silk 391	 Majestic Blue 296
 Light Peach 362	 Dark Indigo 288
 Rosaline 508	 Montana 207
 Rose Water Opal 395	 Denim Blue 266
 Vintage Rose 319	 Light Turquoise 263
 Blush Rose 257	 Blue Zircon 229
 Light Rose 223	 Erinite 360
 Rose Peach 262	 Peridot 214
 Padparadscha 542	 Citrus Green 337
 Rose 209	 Fern Green 291
 Fuchsia 502	 Emerald 205
 Light Siam 227	 Jonquil 213
 Scarlet 276	 Light Topaz 226
 Siam 208	 Sunflower 292
 Ruby 501	 Golden Topaz 1003
 Amethyst 204	 Light Colorado Topaz 246
 Iris 219	 Topaz 203
 Light Amethyst 212	 Light Amber 1002
 Violet 371	 Smoked Amber 1001
 Tanzanite 539	 Greige 284
 Purple Velvet 277	 Black Diamond 215
 Light Azore 361	 Jet 280
 Aquamarine 202	









Effects

 Crystal Moonlight 001 MOL	 Light Amethyst Shimmer 212 SHIM
 Crystal Shimmer 001 SHIM	 Aquamarine Shimmer 202 SHIM
 Crystal Aurore Boreale 001 AB	 Light Sapphire Shimmer 211 SHIM
 Crystal Antique Pink 001 ANTP	 Peridot Shimmer 214 SHIM
 Crystal Paradise Shine 001 PARSH	 Erinite Shimmer 360 SHIM
 Crystal Vitrail Medium 001 VM	 Emerald Shimmer 205 SHIM
 Crystal Blue Shade 001 BLSH	 Light Topaz Shimmer 226 SHIM
 Crystal Golden Shadow 001 GSHA	 Light Colorado Topaz Shimmer 246 SHIM
 Crystal Metallic Sunshine 001 METSH	 Black Diamond Shimmer 215 SHIM
 Crystal Rose Gold 001 ROGL	 Jet Shimmer 280 SHIM
 Crystal Metallic Light Gold 001 MLGLD	

AB Effects

 Light Rose Aurore Boreale 223 AB
 Rose Aurore Boreale 209 AB
 Light Siam Aurore Boreale 227 AB
 Amethyst Aurore Boreale 204 AB
 Iris Aurore Boreale 219 AB
 Violet Aurore Boreale 371 AB
 Purple Velvet Aurore Boreale 277 AB
 Aquamarine Aurore Boreale 202 AB
 Light Sapphire Aurore Boreale 211 AB
 Sapphire Aurore Boreale 206 AB
 Capri Blue Aurore Boreale 243 AB
 Peridot Aurore Boreale 214 AB
 Fern Green Aurore Boreale 291 AB
 Jet Aurore Boreale 280 AB

Shimmer Effects

 White Opal Shimmer 234 SHIM
 Rose Water Opal Shimmer 395 SHIM
 Light Rose Shimmer 223 SHIM
 Rose Shimmer 209 SHIM
 Light Siam Shimmer 227 SHIM
 Scarlet Shimmer 276 SHIM
 Siam Shimmer 208 SHIM
 Amethyst Shimmer 204 SHIM

Numerical Order

001	Crystal	211 AB	Light Sapphire Aurore Boreale	276 SHIM	Scarlet Shimmer
001 AB	Crystal Aurore Boreale	211 SHIM	Light Sapphire Shimmer	276	Scarlet
001 ANTP	Crystal Antique Pink	211	Light Sapphire	277 AB	Purple Velvet Aurore Boreale
001 BLSH	Crystal Blue Shade	212 SHIM	Light Amethyst Shimmer	277	Purple Velvet
001 CAL	Crystal Comet Argent Light	212	Light Amethyst	280 AB	Jet Aurore Boreale
001 GSHA	Crystal Golden Shadow	213	Jonquil	280 HEM	Jet Hematite
001 LTCH	Crystal Light Chrome	214 AB	Peridot Aurore Boreale	280 SHIM	Jet Shimmer
001 METSH	Crystal Metallic Sunshine	214 SHIM	Peridot Shimmer	280	Jet
001 MLGLD	Crystal Metallic Light Gold	214	Peridot	284	Greige
001 MOL	Crystal Moonlight	215 SHIM	Black Diamond Shimmer	288	Dark Indigo
001 PARSH	Crystal Paradise Shine	215	Black Diamond	291 AB	Fern Green Aurore Boreale
001 ROGL	Crystal Rose Gold	219 AB	Iris Aurore Boreale	291	Fern Green
001 SHIM	Crystal Shimmer	219	Iris	292	Sunflower
001 SINI	Crystal Silver Night	223 AB	Light Rose Aurore Boreale	296	Majestic Blue
001 SSHA	Crystal Silver Shade	223 SHIM	Light Rose Shimmer	319	Vintage Rose
001 VM	Crystal Vitrail Medium	223	Light Rose	337	Citrus Green
202 AB	Aquamarine Aurore Boreale	226 SHIM	Light Topaz Shimmer	360 SHIM	Erinite Shimmer
202 SHIM	Aquamarine Shimmer	226	Light Topaz	360	Erinite
202	Aquamarine	227 AB	Light Siam Aurore Boreale	361	Light Azore
203	Topaz	227 SHIM	Light Siam Shimmer	362	Light Peach
204 AB	Amethyst Aurore Boreale	227	Light Siam	371 AB	Violet Aurore Boreale
204 SHIM	Amethyst Shimmer	229	Blue Zircon	371	Violet
204	Amethyst	234 SHIM	White Opal Shimmer	391	Silk
205 SHIM	Emerald Shimmer	234	White Opal	395 SHIM	Rose Water Opal Shimmer
205	Emerald	243 AB	Capri Blue Aurore Boreale	395	Rose Water Opal
206 AB	Sapphire Aurore Boreale	243	Capri Blue	501	Ruby
206	Sapphire	246 SHIM	Light Colorado Topaz Shimmer	502	Fuchsia
207	Montana	246	Light Colorado Topaz	508	Rosaline
208 SHIM	Siam Shimmer	257	Blush Rose	539	Tanzanite
208	Siam	261	Light Silk	542	Padparadscha
209 AB	Rose Aurore Boreale	262	Rose Peach	1001	Smoked Amber
209 SHIM	Rose Shimmer	263	Light Turquoise	1002	Light Amber
209	Rose	266	Denim Blue	1003	Golden Topaz

Alphabetical Order

Amethyst (204)	Erinite (360)	Light Turquoise (263)
Amethyst Aurore Boreale (204 AB)	Erinite Shimmer (360 SHIM)	Majestic Blue (296)
Amethyst Shimmer (204 SHIM)	Fern Green (291)	Montana (207)
Aquamarine (202)	Fern Green Aurore Boreale (291 AB)	Padparadscha (542)
Aquamarine Aurore Boreale (202 AB)	Fuchsia (502)	Peridot (214)
Aquamarine Shimmer (202 SHIM)	Golden Topaz (1003)	Peridot Aurore Boreale (214 AB)
Black Diamond (215)	Greige (284)	Peridot Shimmer (214 SHIM)
Black Diamond Shimmer (215 SHIM)	Iris (219)	Purple Velvet (277)
Blue Zircon (229)	Iris Aurore Boreale (219 AB)	Purple Velvet Aurore Boreale (277 AB)
Blush Rose (257)	Jet (280)	Rosaline (508)
Capri Blue (243)	Jet Aurore Boreale (280 AB)	Rose (209)
Capri Blue Aurore Boreale (243 AB)	Jet Hematite (280 HEM)	Rose Aurore Boreale (209 AB)
Citrus Green (337)	Jet Shimmer (280 SHIM)	Rose Peach (262)
Crystal (001)	Jonquil (213)	Rose Shimmer (209 SHIM)
Crystal Antique Pink (001 ANTP)	Light Amber (1002)	Rose Water Opal (395)
Crystal Aurore Boreale (001 AB)	Light Amethyst (212)	Rose Water Opal Shimmer (395 SHIM)
Crystal Blue Shade (001 BLSH)	Light Amethyst Shimmer (212 SHIM)	Ruby (501)
Crystal Comet Argent Light (001 CAL)	Light Azore (361)	Sapphire (206)
Crystal Golden Shadow (001 GSHA)	Light Colorado Topaz (246)	Sapphire Aurore Boreale (206 AB)
Crystal Light Chrome (001 LTCH)	Light Colorado Topaz Shimmer (246 SHIM)	Scarlet (276)
Crystal Metallic Light Gold (001 MLGLD)	Light Peach (362)	Scarlet Shimmer (276 SHIM)
Crystal Metallic Sunshine (001 METSH)	Light Rose (223)	Siam (208)
Crystal Moonlight (001 MOL)	Light Rose Aurore Boreale (223 AB)	Siam Shimmer (208 SHIM)
Crystal Paradise Shine (001 PARSH)	Light Rose Shimmer (223 SHIM)	Silk (391)
Crystal Rose Gold (001 ROGL)	Light Sapphire (211)	Smoked Amber (1001)
Crystal Shimmer (001 SHIM)	Light Sapphire Aurore Boreale (211 AB)	Sunflower (292)
Crystal Silver Night (001 SINI)	Light Sapphire Shimmer (211 SHIM)	Tanzanite (539)
Crystal Silver Shade (001 SSHA)	Light Siam (227)	Topaz (203)
Crystal Vitrail Medium (001 VM)	Light Siam Aurore Boreale (227 AB)	Vintage Rose (319)
Dark Indigo (288)	Light Siam Shimmer (227 SHIM)	Violet (371)
Denim Blue (266)	Light Silk (261)	Violet Aurore Boreale (371 AB)
Emerald (205)	Light Topaz (226)	White Opal (234)
Emerald Shimmer (205 SHIM)	Light Topaz Shimmer (226 SHIM)	White Opal Shimmer (234 SHIM)

For details on available colors and effects for each article within the product groups, please see the product matrix of the respective item in the Collection 2023.

The plating resistance of effects is tested according to Swarovski's plating guidelines (SWAROVSKI.COM/S-PROFESSIONALS). Customers are advised to carry out their own tests if their plating parameters diverge from Swarovski plating guidelines.

For more 1x/2x effect options please refer to the specific article overviews.

Colors and effects can appear different when illuminated with different light sources. Swarovski uses standard light source D65 for color decision and comparison. Slight changes in shades are unavoidable. Colors may vary according to cut and foiling.

The composition of Advanced Crystal is compliant with regulatory industry norms and laws regarding the restriction or prohibition of certain substances in the most relevant segments of our customers. Please note that the compliance of the colors Light Siam and Siam varies according to certain industry regulations. Those regulations are indicated with * in the compliance overview. Indian Siam, Ruby and Scarlet (option to Lt. Siam) conform to all CLEAR-lists. For further information please visit swarovski.com/s-professionals

© 2023 D. Swarovski Distribution GmbH

Summary

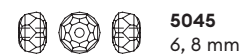
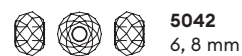
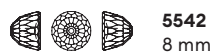

5000 Classic Bead

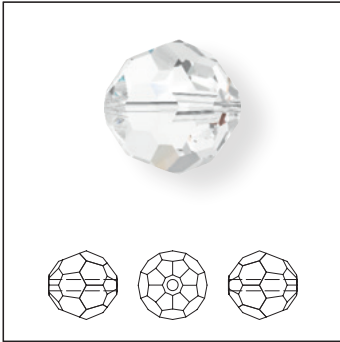

Size	2 mm	3 mm	4 mm	5 mm	6 mm	8 mm	10 mm	12 mm
------	------	------	------	------	------	------	-------	-------

Crystal























Crystal (001)

Colors

Plain Colors

- Amethyst (204)
- Aquamarine (202)
- Black Diamond (215)
- Blue Zircon (229)
- Capri Blue (243)
- Citrus Green (337)
- Denim Blue (266)
- Emerald (205)
- Erinite (360)
- Fuchsia (502)
- Golden Topaz (1003)
- Jet (280)
- Jonquil (213)
- Light Amber (1002)
- Light Amethyst (212)
- Light Azore (361)
- Light Colorado Topaz (246)
- Light Rose (223)
- Light Sapphire (211)
- Light Siam (227)
- Light Topaz (226)
- Light Turquoise (263)
- Montana (207)
- Peridot (214)
- Rose (209)
- Rose Peach (262)
- Sapphire (206)
- Scarlet (276)
- Siam (208)
- Silk (391)
- Smoked Amber (1001)
- Tanzanite (539)
- Topaz (203)
- Vintage Rose (319)
- Violet (371)

Crystal (001)	■	■	■	■	■	■	■	■
Amethyst (204)		■	■	■		■	■	■
Aquamarine (202)	■	■	■	■	■	■	■	
Black Diamond (215)	■		■	■	■	■		
Blue Zircon (229)			■		■	■		
Capri Blue (243)			■		■	■		
Citrus Green (337)			■		■	■		
Denim Blue (266)	■	■	■	■	■	■		
Emerald (205)	■	■	■	■	■	■	■	
Erinite (360)			■		■	■		
Fuchsia (502)		■	■		■	■		
Golden Topaz (1003)			■		■			
Jet (280)	■	■	■	■	■	■	■	
Jonquil (213)			■		■	■		
Light Amber (1002)			■		■			
Light Amethyst (212)			■		■	■		
Light Azore (361)			■		■	■		
Light Colorado Topaz (246)	■	■	■	■	■	■	■	
Light Rose (223)	■	■	■	■	■	■	■	
Light Sapphire (211)			■		■	■		
Light Siam (227)	■	■	■		■	■	■	
Light Topaz (226)			■		■	■		
Light Turquoise (263)			■		■	■		
Montana (207)	■	■	■	■	■	■		
Peridot (214)			■		■	■		
Rose (209)	■	■	■	■	■	■		
Rose Peach (262)			■		■	■		
Sapphire (206)			■		■	■		
Scarlet (276)		■	■		■	■	■	
Siam (208)	■	■	■		■	■	■	
Silk (391)			■		■	■		
Smoked Amber (1001)			■		■			
Tanzanite (539)	■		■		■	■		
Topaz (203)			■		■	■		
Vintage Rose (319)	■	■	■	■	■	■		
Violet (371)			■		■	■		

5000		Size	2 mm	3 mm	4 mm	5 mm	6 mm	8 mm	10 mm	12 mm
Opal Colors										
 White Opal (234)				■	■		■	■		
Crystal Effects										
Transparent Effects										
 Crystal Aurore Boreale (001 AB)			■	■	■	■	■	■	■	■
 Crystal Blue Shade (001 BLSH)					■		■	■		
 Crystal Golden Shadow (001 GSHA)			■	■	■		■	■	■	
 Crystal Moonlight (001 MOL)			■		■		■	■		
 Crystal Shimmer (001 SHIM)					■		■	■		
 Crystal Silver Night (001 SINI)			■	■	■		■	■		
 Crystal Silver Shade (001 SSHA)			■	■	■		■	■		
Metallic Effects										
 Crystal Light Chrome (001 LTCH)			■	■	■		■	■		
 Crystal Rose Gold (001 ROGL)				■	■		■			
Color Effects										
Transparent Effects										
 Amethyst Shimmer (204 SHIM)					■		■	■		
 Aquamarine Shimmer (202 SHIM)					■		■	■		
 Jet Aurore Boreale (280 AB)					■		■	■		
 Light Amethyst Shimmer (212 SHIM)					■		■	■		
 Light Rose Shimmer (223 SHIM)					■		■	■		
 Light Siam Aurore Boreale (227 AB)					■		■	■		
 Peridot Shimmer (214 SHIM)					■		■	■		
 Rose Aurore Boreale (209 AB)					■		■	■		
 Rose Shimmer (209 SHIM)					■		■	■		
 Rose Water Opal Shimmer (395 SHIM)					■		■	■		
 Siam Shimmer (208 SHIM)					■		■	■		
 White Opal Shimmer (234 SHIM)					■		■	■		

5003 Disco Ball Bead



Size
6 mm
8 mm
10 mm
12 mm

Crystal

Crystal (001)

Crystal Effects

Transparent Effects

Crystal Aurore Boreale (001 AB)

5020 Helix Bead

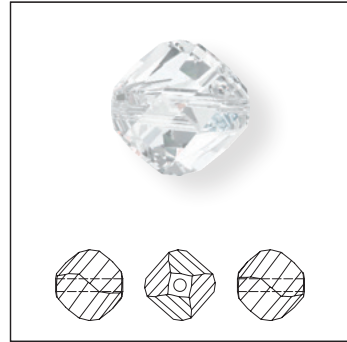

Size
6 mm
8 mm
10 mm

Crystal

Crystal (001)

Crystal Effects

Transparent Effects

Crystal Aurore Boreale (001 AB)

Crystal Golden Shadow (001 GSHA)

5028/4 Crystal Globe Bead

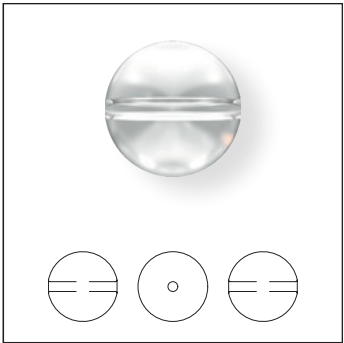

Size
6 mm
8 mm
10 mm

Crystal

Crystal (001)

Crystal Effects

Transparent Effects

Crystal Aurore Boreale (001 AB)

5040 Briolette Bead

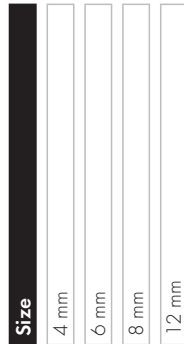

Crystal

Crystal (001)

Colors

Plain Colors

- Amethyst (204)
- Aquamarine (202)
- Blue Zircon (229)
- Emerald (205)
- Erinite (360)
- Iris (219)
- Jet (280)
- Light Amethyst (212)
- Light Colorado Topaz (246)
- Light Rose (223)
- Light Sapphire (211)
- Light Siam (227)
- Light Topaz (226)
- Light Turquoise (263)
- Peridot (214)
- Rose (209)
- Sapphire (206)
- Scarlet (276)
- Siam (208)
- Tanzanite (539)
- Topaz (203)
- Violet (371)

Crystal Effects

Transparent Effects

- Crystal Aurore Boreale (001 AB)
- Crystal Golden Shadow (001 GSHA)
- Crystal Shimmer 2X (001 SHIM2X)
- Crystal Silver Night (001 SINI)
- Crystal Silver Shade (001 SSHA)

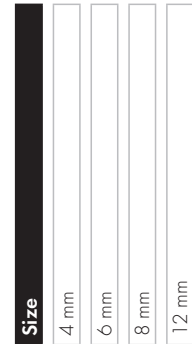
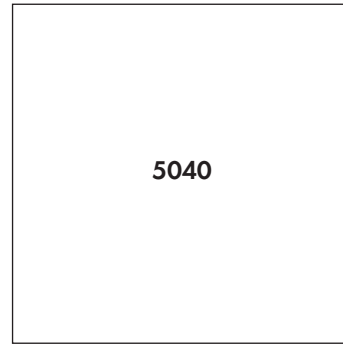

Color Effects

Transparent Effects

- Amethyst Shimmer 2X (204 SHIM2X)
- Aquamarine Shimmer 2x (202 SHIM2)
- Black Diamond Shimmer 2X (215 SHIM2X)
- Erinite Shimmer 2X (360 SHIM2X)
- Light Amethyst Shimmer 2x (212 SHIM2X)
- Light Colorado Topaz Shimmer 2X (246 SHIM2X)
- Light Rose Shimmer 2X (223 SHIM2X)
- Light Sapphire Shimmer 2X (211 SHIM2X)
- Light Siam Shimmer 2X (227 SHIM2X)
- Light Topaz Shimmer 2X (226 SHIM2X)
- Rose Water Opal Shimmer 2X (395 SHIM2X)
- White Opal Shimmer 2X (234 SHIM2X)

5042 Briolette XL Hole Bead

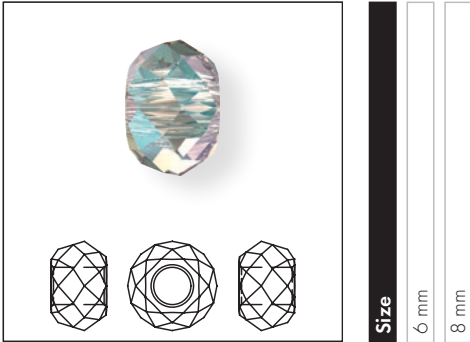

Crystal Effects	
Transparent Effects	
Crystal Shimmer 2X (001 SHIM2X)	■ ■
Color Effects	
Transparent Effects	
Amethyst Shimmer 2X (204 SHIM2X)	■ ■
Aquamarine Shimmer 2x (202 SHIM2)	■ ■
Emerald Shimmer 2X (205 SHIM2X)	■ ■
Jet Shimmer 2X (280 SHIM2X)	■ ■
Light Colorado Topaz Shimmer 2X (246 SHIM2X)	■ ■
Scarlet Shimmer 2X (276 SHIM2X)	■ ■

5043 Briolette XXL Hole Bead

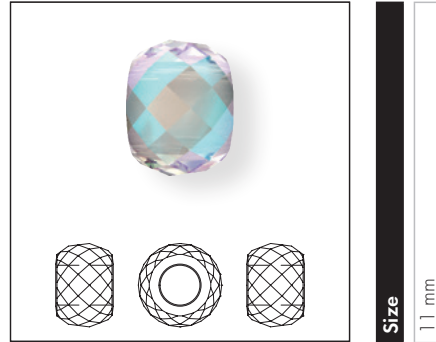

Crystal Effects	
Transparent Effects	
Crystal Shimmer 2X (001 SHIM2X)	■ ■
Color Effects	
Transparent Effects	
Amethyst Shimmer 2X (204 SHIM2X)	■ ■
Aquamarine Shimmer 2x (202 SHIM2)	■ ■
Emerald Shimmer 2X (205 SHIM2X)	■ ■
Jet Shimmer 2X (280 SHIM2X)	■ ■
Light Colorado Topaz Shimmer 2X (246 SHIM2X)	■ ■
Scarlet Shimmer 2X (276 SHIM2X)	■ ■

5044 Olive Briolette Bead



Size
5x4 mm
7x6 mm
9,5x8 mm

Crystal		
Crystal (001)	■	■
Colors		
Plain Colors		
Amethyst (204)	■	■
Aquamarine (202)	■	■
Blue Zircon (229)	■	■
Emerald (205)	■	■
Jet (280)	■	■
Light Amber (1002)	■	■
Light Rose (223)	■	■
Light Siam (227)	■	■
Light Turquoise (263)	■	■
Peridot (214)	■	■
Rose Peach (262)	■	■
Violet (371)	■	■
Crystal Effects		
Transparent Effects		
Crystal Aurore Boreale (001 AB)	■	■
Crystal Golden Shadow (001 GSHA)	■	■

5045 Rondelle Bead



Size
6 mm
8 mm

Crystal		
Crystal (001)	■	■
Crystal Effects		
Transparent Effects		
Crystal Aurore Boreale (001 AB)	■	■

5305 Slim XILION Bead

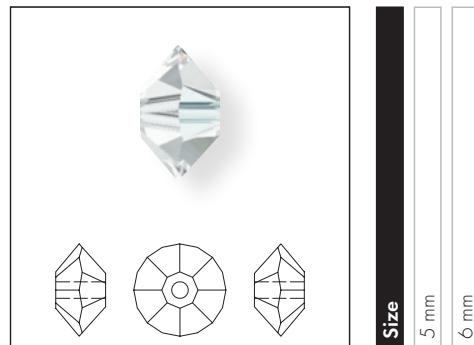

Size
5 mm
6 mm

Crystal		
Crystal (001)	■	■
Crystal Effects		
Transparent Effects		
Crystal Aurore Boreale (001 AB)	■	■

5328 XILION Bead



Size	2.5 mm	3 mm	4 mm	5 mm	6 mm	8 mm	10 mm
------	--------	------	------	------	------	------	-------

Crystal

Crystal (001)

Colors















Plain Colors

- Amethyst (204)
- Aquamarine (202)
- Black Diamond (215)
- Blue Zircon (229)
- Blush Rose (257)
- Capri Blue (243)
- Citrus Green (337)
- Dark Indigo (288)
- Denim Blue (266)
- Emerald (205)
- Erinite (360)
- Fern Green (291)
- Fuchsia (502)
- Golden Topaz (1003)
- Greige (284)
- Iris (219)
- Jet (280)
- Jonquil (213)
- Light Amber (1002)
- Light Amethyst (212)
- Light Azore (361)
- Light Colorado Topaz (246)
- Light Peach (362)
- Light Rose (223)
- Light Sapphire (211)
- Light Siam (227)
- Light Silk (261)
- Light Topaz (226)
- Light Turquoise (263)
- Majestic Blue (296)
- Montana (207)

Crystal (001)	■	■	■	■	■	■	■
Amethyst (204)	■	■	■	■	■	■	■
Aquamarine (202)	■	■	■	■	■	■	■
Black Diamond (215)		■	■	■	■	■	■
Blue Zircon (229)		■	■	■	■	■	■
Blush Rose (257)		■	■	■	■		
Capri Blue (243)		■	■	■	■		
Citrus Green (337)		■	■	■	■		
Dark Indigo (288)		■	■		■		
Denim Blue (266)		■	■	■	■		
Emerald (205)	■	■	■	■	■	■	
Erinite (360)		■	■	■	■		
Fern Green (291)		■	■		■		
Fuchsia (502)		■	■	■	■		
Golden Topaz (1003)		■	■				
Greige (284)		■	■				
Iris (219)		■	■	■	■		
Jet (280)	■	■	■	■	■	■	
Jonquil (213)		■	■				
Light Amber (1002)		■	■				
Light Amethyst (212)		■	■	■	■		
Light Azore (361)		■	■	■	■		
Light Colorado Topaz (246)	■	■	■	■	■	■	
Light Peach (362)		■	■	■	■		
Light Rose (223)	■	■	■	■	■	■	
Light Sapphire (211)		■	■	■	■		
Light Siam (227)		■	■	■	■	■	
Light Silk (261)		■	■		■		
Light Topaz (226)		■	■	■	■		
Light Turquoise (263)		■	■	■	■	■	
Majestic Blue (296)		■	■	■	■		
Montana (207)		■	■	■	■		

5328	Size						
	2.5 mm	3 mm	4 mm	5 mm	6 mm	8 mm	10 mm
Padparadscha (542)		■	■				
Peridot (214)		■	■	■	■	■	■
Purple Velvet (277)		■	■		■		
Rosaline (508)		■	■	■	■		
Rose (209)		■	■	■	■		
Rose Peach (262)		■	■	■	■		
Ruby (501)		■	■	■	■		
Sapphire (206)		■	■	■	■	■	
Scarlet (276)	■	■	■	■	■		
Siam (208)		■	■	■	■	■	
Silk (391)		■	■	■	■		
Smoked Amber (1001)		■	■				
Sunflower (292)		■	■		■		
Tanzanite (539)		■	■	■	■		
Topaz (203)		■	■	■	■		
Vintage Rose (319)		■	■	■	■		
Violet (371)		■	■	■	■		
Opal Colors							
Rose Water Opal (395)		■	■	■	■		
White Opal (234)		■	■	■	■		
Crystal Effects							
Transparent Effects							
Crystal Antique Pink (001 ANTP)		■	■				
Crystal Aurore Boreale (001 AB)	■	■	■	■	■	■	■
Crystal Aurore Boreale 2x (001 AB2)		■	■	■	■		
Crystal Blue Shade (001 BLSH)		■	■	■	■		
Crystal Golden Shadow (001 GSHA)	■	■	■	■	■	■	
Crystal Moonlight (001 MOL)		■	■	■	■		
Crystal Paradise Shine (001 PARSH)		■	■	■	■		
Crystal Paradise Shine 2x (001 PARS2)			■				
Crystal Shimmer (001 SHIM)		■	■	■	■		
Crystal Shimmer 2X (001 SHIM2X)		■	■				
Crystal Silver Night (001 SINI)		■	■	■			
Crystal Silver Shade (001 SSHA)	■	■	■	■	■	■	
Crystal Vitrail Medium (001 VM)		■	■				

5328	Size							
	2.5 mm	3 mm	4 mm	5 mm	6 mm	8 mm	10 mm	
Metallic Effects								
Crystal Comet Argent Light (001 CAL)		■	■	■	■			
Crystal Light Chrome (001 LTCH)		■	■					
Crystal Light Chrome 2x (001 LTCH2)			■					
Crystal Metallic Light Gold 2x (001 MLG2)		■	■		■			
Crystal Metallic Sunshine (001 METSH)		■	■	■	■			
Crystal Metallic Sunshine 2x (001 MTSH2)			■					
Crystal Rose Gold (001 ROGL)		■	■					
Crystal Rose Gold 2x (001 ROGL2)		■	■	■	■			
Color Effects								
Transparent Effects								
Amethyst Aurore Boreale (204 AB)		■	■					
Amethyst Shimmer (204 SHIM)		■	■		■			
Amethyst Shimmer 2X (204 SHIM2X)		■	■					
Aquamarine Aurore Boreale (202 AB)		■	■					
Aquamarine Shimmer (202 SHIM)		■	■	■	■			
Aquamarine Shimmer 2x (202 SHIM2)		■	■					
Black Diamond Shimmer (215 SHIM)		■	■		■			
Black Diamond Shimmer 2X (215 SHIM2X)		■	■					
Capri Blue Aurore Boreale (243 AB)		■	■					
Fern Green Aurore Boreale (291 AB)		■	■		■			
Iris Aurore Boreale 2X (219 AB2)		■	■					
Jet Aurore Boreale (280 AB)		■	■	■	■			
Jet Aurore Boreale 2x (280 AB2)		■	■					
Light Amethyst Shimmer (212 SHIM)		■	■		■			
Light Amethyst Shimmer 2x (212 SHIM2X)		■	■					
Light Rose Aurore Boreale (223 AB)		■	■	■	■			
Light Rose Aurore Boreale 2x (223 AB2)		■	■					
Light Rose Shimmer (223 SHIM)		■	■		■			
Light Rose Shimmer 2X (223 SHIM2X)		■	■					
Light Sapphire Aurore Boreale (211 AB)		■	■					
Light Sapphire Shimmer 2X (211 SHIM2X)		■	■					
Light Siam Aurore Boreale (227 AB)		■	■					
Light Siam Shimmer 2X (227 SHIM2X)		■	■					
Peridot Aurore Boreale (214 AB)			■					
Peridot Shimmer (214 SHIM)		■	■	■	■			
Peridot Shimmer 2x (214 SHIM2X)		■	■					

5328									
		Size	2.5 mm	3 mm	4 mm	5 mm	6 mm	8 mm	10 mm
	Purple Velvet Aurore Boreale (277 AB)			■	■			■	
	Rose Aurore Boreale (209 AB)		■	■					
	Rose Shimmer (209 SHIM)		■	■			■		
	Rose Shimmer 2x (209 SHIM2X)		■	■					
	Rose Water Opal Shimmer (395 SHIM)		■	■		■	■		
	Rose Water Opal Shimmer 2X (395 SHIM2X)		■	■					
	Sapphire Aurore Boreale (206 AB)		■	■					
	Siam Shimmer (208 SHIM)		■	■			■		
	Siam Shimmer 2x (208 SHIM2X)		■	■					
	Violet Aurore Boreale (371 AB)		■	■					
	White Opal Shimmer (234 SHIM)		■	■		■	■		
	White Opal Shimmer 2X (234 SHIM2X)		■	■					
Metallic Effects									
	Jet Hematite (280 HEM)		■	■					
	Jet Hematite 2x (280 HEM2)		■	■					

5500 Drop Bead



Size

9x6 mm

12x8 mm

Crystal

Crystal (001)

Colors

Plain Colors

- Amethyst (204)
- Aquamarine (202)
- Blue Zircon (229)
- Citrus Green (337)
- Emerald (205)
- Light Amethyst (212)
- Light Colorado Topaz (246)
- Light Rose (223)
- Light Siam (227)
- Light Topaz (226)
- Peridot (214)
- Rose (209)
- Sapphire (206)
- Scarlet (276)
- Siam (208)
- Topaz (203)

Crystal Effects

Transparent Effects

- Crystal Aurore Boreale (001 AB)
- Crystal Golden Shadow (001 GSHA)
- Crystal Shimmer 2X (001 SHIM2X)

Color Effects

Transparent Effects

- Amethyst Shimmer 2X (204 SHIM2X)
- Aquamarine Shimmer 2x (202 SHIM2)
- Light Colorado Topaz Shimmer 2X (246 SHIM2X)
- Light Siam Shimmer 2X (227 SHIM2X)

5542 Dome Bead small

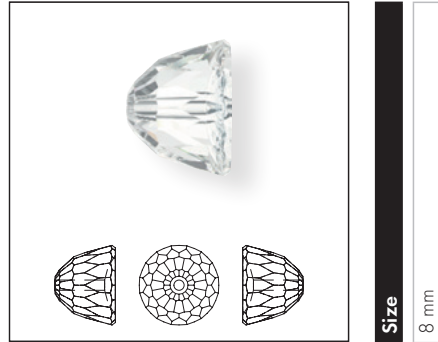

Size

8 mm

Crystal

Crystal (001)

Crystal Effects

Transparent Effects

- Crystal Aurore Boreale (001 AB)
- Crystal Golden Shadow (001 GSHA)

5601 Cube Bead

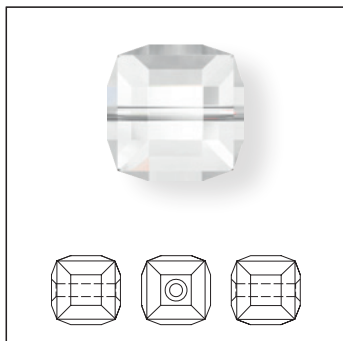

Size	4 mm	6 mm	8 mm	10 mm	12 mm
------	------	------	------	-------	-------

Crystal

Crystal (001)

Colors

Plain Colors

Amethyst (204)

Aquamarine (202)

Black Diamond (215)

Blue Zircon (229)

Blush Rose (257)

Emerald (205)

Erinite (360)

Fuchsia (502)

Iris (219)

Jet (280)

Light Colorado Topaz (246)

Light Sapphire (211)

Light Siam (227)

Light Topaz (226)

Light Turquoise (263)

Majestic Blue (296)

Peridot (214)

Rose Peach (262)

Sapphire (206)

Siam (208)

Smoked Amber (1001)

Tanzanite (539)

















Topaz (203)

Opal Colors

Rose Water Opal (395)

White Opal (234)

Crystal (001)	■	■	■	■	■
Amethyst (204)	■	■	■		
Aquamarine (202)	■	■	■		
Black Diamond (215)	■	■	■		
Blue Zircon (229)	■	■	■		
Blush Rose (257)	■	■	■		
Emerald (205)	■	■	■		
Erinite (360)	■	■	■		
Fuchsia (502)		■	■		
Iris (219)	■	■	■		
Jet (280)	■	■	■		
Light Colorado Topaz (246)	■	■	■		
Light Sapphire (211)	■	■	■		
Light Siam (227)	■	■	■		
Light Topaz (226)	■	■	■		
Light Turquoise (263)	■	■	■		
Majestic Blue (296)	■	■			
Peridot (214)	■	■	■		
Rose Peach (262)	■	■	■		
Sapphire (206)	■	■	■		
Siam (208)	■	■	■		
Smoked Amber (1001)	■	■			
Tanzanite (539)	■	■	■		
Topaz (203)	■	■	■		
Rose Water Opal (395)	■	■			
White Opal (234)	■	■			

5601		Size	4 mm	6 mm	8 mm	10 mm	12 mm
Crystal Effects							
Transparent Effects							
 Crystal Aurore Boreale B (001 ABB)			■	■	■	■	
 Crystal Blue Shade B (001 BLSB)			■	■	■		
 Crystal Golden Shadow B (001 GSHAB)			■	■	■		
 Crystal Shimmer B (001 SHIMB)			■	■	■		
 Crystal Silver Night B (001 SINIB)			■	■	■		
 Crystal Vitrail Medium B (001 VMB)			■	■	■		
Metallic Effects							
 Crystal Light Chrome B (001 LTCHB)			■	■	■		
 Crystal Metallic Sunshine B (001 MTSHB)			■	■	■		
 Crystal Rose Gold B 2x (001 ROGB2)			■	■			
Color Effects							
Transparent Effects							
 Black Diamond Shimmer B (215 SHIMB)			■	■	■		
 Erinite Shimmer B (360 SHIMB)			■	■	■		
 Light Colorado Topaz Shimmer B (246 SHIMB)			■	■	■		
 Light Sapphire Shimmer B (211 SHIMB)			■	■	■		
 Light Siam Shimmer B (227 SHIMB)			■	■	■		
 Rose Water Opal Shimmer B (395 SHIMB)			■	■			
 White Opal Shimmer B (234 SHIMB)			■	■			

5714 Star Bead

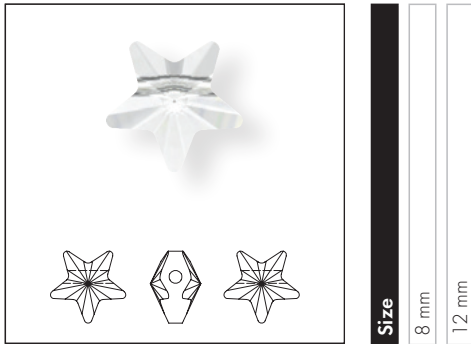

Size
8 mm
12 mm

Crystal

Crystal (001)

Crystal Effects

Transparent Effects

Crystal Aurore Boreale (001 AB)

5741 Love Bead

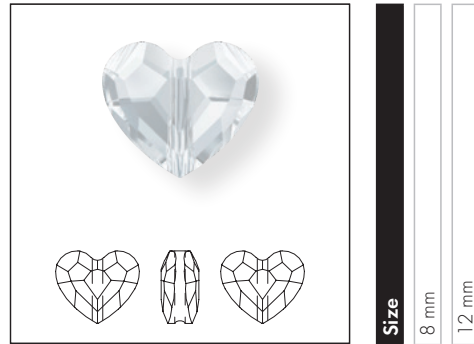

Size
8 mm
12 mm

Crystal

Crystal (001)

Colors

Plain Colors

Blush Rose (257)

Light Siam (227)

Rose (209)

Crystal Effects

Transparent Effects

Crystal Aurore Boreale (001 AB)

Crystal Silver Night 2x (001 SINI2)

5742 Heart Bead

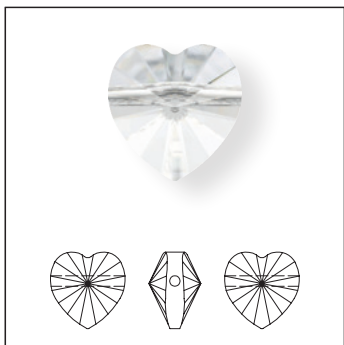

Size
8 mm
10 mm

Crystal

Crystal (001)

Crystal Effects

Transparent Effects

Crystal Aurore Boreale (001 AB)

5750 Skull Bead

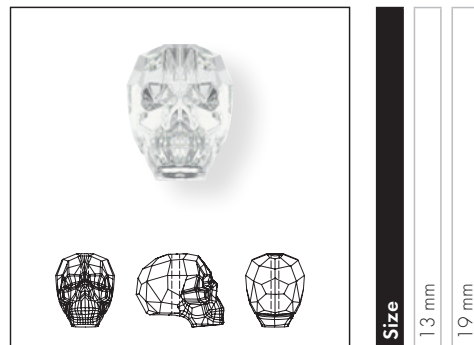

Size
13 mm
19 mm

Crystal

Crystal (001)

Colors

Plain Colors

Jet (280)

Crystal Effects

Transparent Effects

Crystal Paradise Shine (001 PARSH)

Crystal Silver Night (001 SINI)

Crystal Silver Night 2x (001 SINI2)

Metallic Effects

Crystal Metallic Light Gold 2x (001 MIG2)

5752 Clover Bead

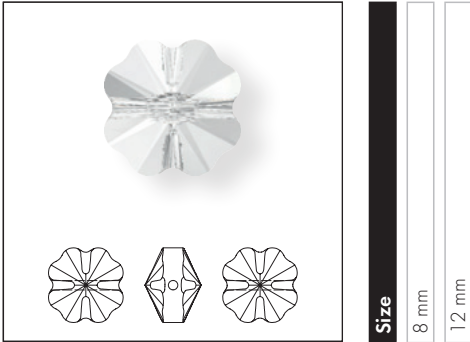

Crystal	
Crystal (001)	
Colors	
Plain Colors	
Fern Green (291)	
Crystal Effects	
Transparent Effects	
Crystal Aurore Boreale (001 AB)	
Crystal Golden Shadow (001 GSHA)	

5754 Butterfly Bead

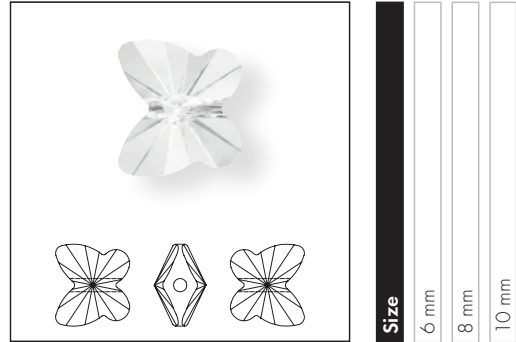

Crystal	
Crystal (001)	
Colors	
Plain Colors	
Fuchsia (502)	
Jet (280)	
Light Rose (223)	
Light Siam (227)	
Violet (371)	
Crystal Effects	
Transparent Effects	
Crystal Aurore Boreale (001 AB)	
Crystal Golden Shadow (001 GSHA)	

Product Details

Article Size	Packing Unit = Minimum Order Quantity in Pieces	Average Net Weight in Gram per Packing Unit Crystal (001)	Average Gross Weight in Gram per Packing Unit Crystal (001)
5000			
2 mm	1,440	11.5	20.8
3 mm	720	23.6	33.4
4 mm	720	53.5	62.6
5 mm	720	105.3	116.3
6 mm	360	81.6	92.5
8 mm	288	193.5	200.8
10 mm	144	180.6	199.4
12 mm	72	144.2	166.1
5003			
6 mm	360	109.9	120.8
8 mm	144	100.4	118.6
10 mm	144	195.9	219.2
12 mm	72	158.5	179.2
5020			
6 mm	360	74.5	85.2
8 mm	288	146.6	178.2
10 mm	144	116.4	139.2
5028/4			
6 mm	360	75.791	83.4
8 mm	144	74.714	85.6
10 mm	72	70.763	76.5
5040			
4 mm	720	41.3	50.4
6 mm	360	71.8	82.9
8 mm	288	135.6	163.7
12 mm	144	214.4	242.4
5042			
6 mm	288	45.7	69.3
8 mm	216	93.4	120.2
5043			
11 mm	12	13.2	31.8
5044			
5x4 mm	360	37.6	47.8
7x6 mm	288	98.1	108.3
9.5x8 mm	72	58.6	77.0
5045			
6 mm	288	60.7	70.9
8 mm	216	117.5	145.9
5305			
5 mm	720	52.7	63.9
6 mm	360	50.5	61.4

Article Size	Packing Unit = Minimum Order Quantity in Pieces	Average Net Weight in Gram per Packing Unit Crystal (001)	Average Gross Weight in Gram per Packing Unit Crystal (001)
5328			
2.5 mm	1,440	23.8	31.4
3 mm	1,440	34.1	45.2
4 mm	1,440	81.8	89.2
5 mm	720	89.3	100.0
6 mm	360	73.7	84.6
8 mm	288	141.8	173.4
10 mm	144	140.4	154.0
5500			
9x6 mm	144	59.0	69.9
12x8 mm	144	144.0	164.1
5542			
8 mm	96	81.4	102.9
5601			
4 mm	288	43.9	65.2
6 mm	144	70.6	88.9
8 mm	96	100.2	118.4
10 mm	72	138.0	156.5
12 mm	36	129.6	147.7
5714			
8 mm	288	73.3	102.1
12 mm	108	72.3	102.2
5741			
8 mm	144	43.3	66.24
12 mm	72	66.2	89.58
5742			
8 mm	288	120.5	154.5
10 mm	288	233.1	266.5
5750			
13 mm	12	24.2	43.8
19 mm	12	73.7	100.0
5752			
8 mm	288	106.1	136.9
12 mm	96	117.7	137.5
5754			
6 mm	360	42.3	53.0
8 mm	288	77.9	109.8
10 mm	288	156.9	188.9