

Fancy Stones

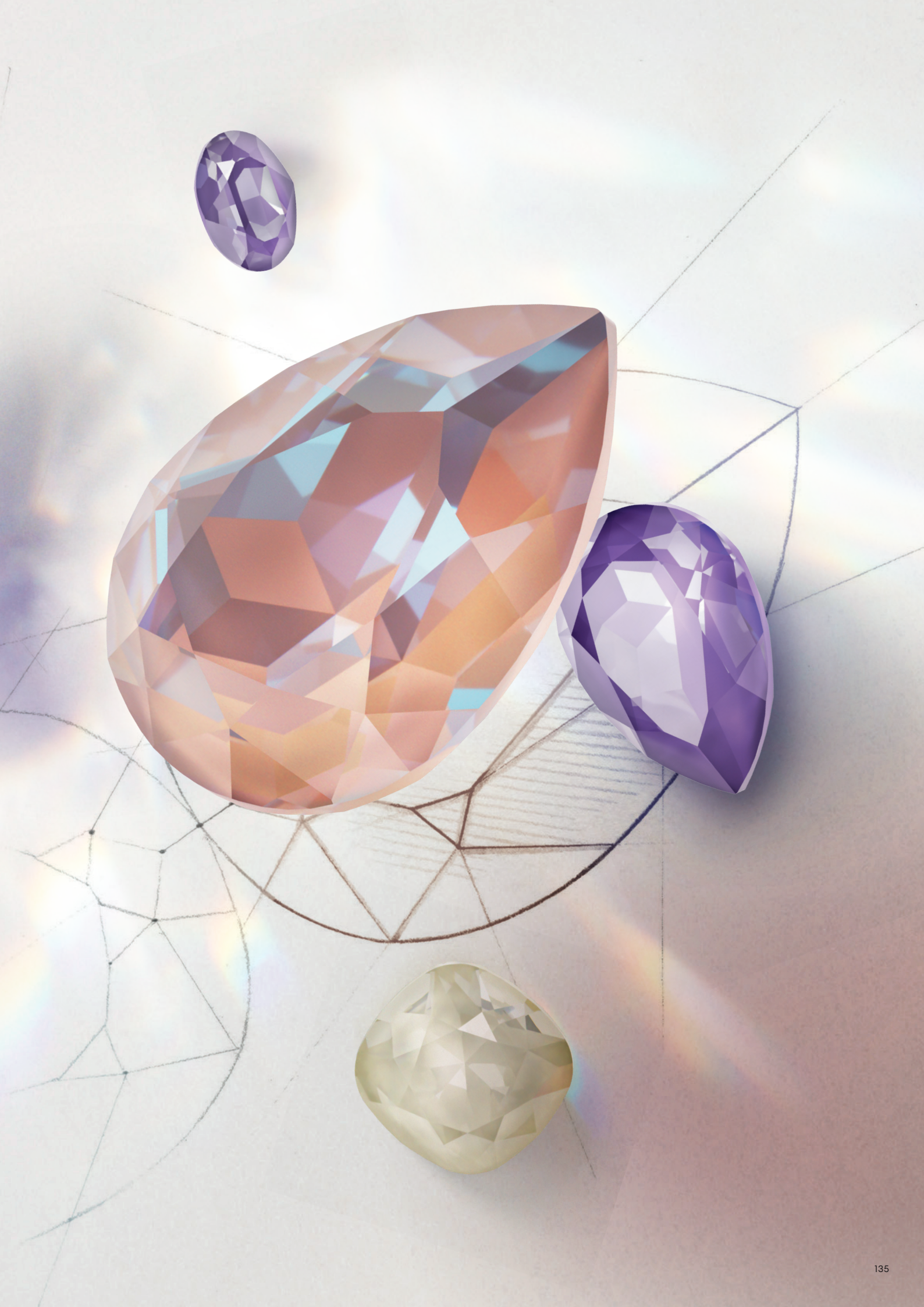

























Fancy Stones are available in a wide range of inspiring shapes from traditional gemstone-inspired cuts to progressive, contemporary stones. Available in a captivating assortment of various sizes and colors, they offer endless creative possibility. Showing either a faceted or non-flat reverse side, Fancy Stones can be glued into pre-cast cavities or used in metal settings. With their precision-cut facets, Fancy Stones deliver unparalleled brilliance to infuse designs with a uniquely captivating shine.













Colors & Effects

OPEN TO SEE COLORS & EFFECTS

Colors



- | | |
|---|---|
|  Crystal
001 |  Erinite
360 |
|  White Opal
234 |  Chrysolite
238 |
|  Light Silk
261 |  Peridot
214 |
|  Rosaline
508 |  Citrus Green
337 |
|  Rose Water Opal
395 |  Emerald
205 |
|  Vintage Rose
319 |  Jonquil
213 |
|  Light Rose
223 |  Light Topaz
226 |
|  Rose Peach
262 |  Golden Topaz
1003 |
|  Rose
209 |  Light Colorado Topaz
246 |
|  Fuchsia
502 |  Light Amber
1002 |
|  Light Siam
227 |  Smoked Amber
1001 |
|  Scarlet
276 |  Black Diamond
215 |
|  Siam
208 |  Jet
280 |
|  Amethyst
204 | |
|  Iris
219 | |
|  Light Amethyst
212 | |
|  Violet
371 | |
|  Tanzanite
539 | |
|  Light Azore
361 | |
|  Aquamarine
202 | |
|  Light Sapphire
211 | |
|  Sapphire
206 | |
|  Montana
207 | |
|  Denim Blue
266 | |
|  Light Turquoise
263 | |

Effects





- | |
|---|
|  Crystal Moonlight
001 MOL |
|  Crystal Aurore Boreale
001 AB |
|  Crystal Vitrail Light
001 VL |
|  Crystal Paradise Shine
001 PARSH |
|  Crystal Vitrail Medium
001 VM |
|  Crystal Volcano
001 VOL |
|  Crystal Bermuda Blue
001 BBL |
|  Crystal Blue Shade
001 BLSH |
|  Crystal Golden Shadow
001 GSHA |
|  Crystal Silver Shade
001 SSHA |
|  Crystal Silver Night
001 SINI |

Crystal Lacquer^{PRO} Effects







Crystal Lacquer^{PRO} DeLite Effects

- | |
|---|
|  Crystal Ivory Cream DeLite
001 L106D |
|  Crystal Dusty Pink DeLite
001 L149D |
|  Crystal Orange Glow DeLite
001 L146D |
|  Crystal Lotus Pink DeLite
001 L145D |
|  Crystal Royal Red DeLite
001 L107D |
|  Crystal Lavender DeLite
001 L144D |
|  Crystal Ocean DeLite
001 L143D |
|  Crystal Royal Blue DeLite
001 L110D |
|  Crystal Laguna DeLite
001 L142D |
|  Crystal Silky Sage DeLite
001 L147D |
|  Crystal Serene Gray DeLite
001 L150D |

Crystal Lacquer^{PRO} Ignite Effects

- | |
|--|
|  Crystal Linen Ignite
001 L164I |
|  Crystal Flamingo Ignite
001 L162I |
|  Crystal Orange Ignite
001 L159I |
|  Crystal Maroon Ignite
001 L160I |
|  Crystal Purple Ignite
001 L161I |
|  Crystal Sky Ignite
001 L163I |

Ignite Effects

- | |
|--|
|  Crystal Ignite
001 IGNIT |
|  Light Rose Ignite
223 IGNIT |
|  Scarlet Ignite
276 IGNIT |
|  Amethyst Ignite
204 IGNIT |
|  Aquamarine Ignite
202 IGNIT |
|  Emerald Ignite
205 IGNIT |
|  Light Colorado Topaz Ignite
246 IGNIT |

Shimmer Effects

- | |
|---|
|  Light Topaz Shimmer
226 SHIM |
|---|

Numerical Order

001	Crystal	001 SINI	Crystal Silver Night	227	Light Siam
001 AB	Crystal Aurore Boreale	001 SSHA	Crystal Silver Shade	234	White Opal
001 BBL	Crystal Bermuda Blue	001 VL	Crystal Vitrail Light	238	Chrysolite
001 BLSH	Crystal Blue Shade	001 VM	Crystal Vitrail Medium	246 IGNIT	Light Colorado Topaz Ignite
001 GSHA	Crystal Golden Shadow	001 VOL	Crystal Volcano	246	Light Colorado Topaz
001 IGNIT	Crystal Ignite	202 IGNIT	Aquamarine Ignite	261	Light Silk
001 LI06D	Crystal Ivory Cream DeLite	202	Aquamarine	262	Rose Peach
001 LI07D	Crystal Royal Red DeLite	204 IGNIT	Amethyst Ignite	263	Light Turquoise
001 LI10D	Crystal Royal Blue DeLite	204	Amethyst	266	Denim Blue
001 LI42D	Crystal Laguna DeLite	205 IGNIT	Emerald Ignite	276 IGNIT	Scarlet Ignite
001 LI43D	Crystal Ocean DeLite	205	Emerald	276	Scarlet
001 LI44D	Crystal Lavender DeLite	206	Sapphire	280	Jet
001 LI45D	Crystal Lotus Pink DeLite	207	Montana	319	Vintage Rose
001 LI46D	Crystal Orange Glow DeLite	208	Siam	337	Citrus Green
001 LI47D	Crystal Silky Sage DeLite	209	Rose	360	Erinite
001 LI49D	Crystal Dusty Pink DeLite	211	Light Sapphire	361	Light Azore
001 LI50D	Crystal Serene Gray DeLite	212	Light Amethyst	371	Violet
001 LI59I	Crystal Orange Ignite	213	Jonquil	395	Rose Water Opal
001 LI60I	Crystal Maroon Ignite	214	Peridot	502	Fuchsia
001 LI61I	Crystal Purple Ignite	215	Black Diamond	508	Rosaline
001 LI62I	Crystal Flamingo Ignite	219	Iris	539	Tanzanite
001 LI63I	Crystal Sky Ignite	223 IGNIT	Light Rose Ignite	1001	Smoked Amber
001 LI64I	Crystal Linen Ignite	223	Light Rose	1002	Light Amber
001 MOL	Crystal Moonlight	226 SHIM	Light Topaz Shimmer	1003	Golden Topaz
001 PARSH	Crystal Paradise Shine	226	Light Topaz		

Alphabetical Order

Amethyst (204)	Crystal Paradise Shine (001 PARSH)	Light Colorado Topaz Ignite (246 IGNIT)
Amethyst Ignite (204 IGNIT)	Crystal Purple Ignite (001 LI61I)	Light Rose (223)
Aquamarine (202)	Crystal Royal Blue DeLite (001 LI10D)	Light Rose Ignite (223 IGNIT)
Aquamarine Ignite (202 IGNIT)	Crystal Royal Red DeLite (001 LI07D)	Light Sapphire (211)
Black Diamond (215)	Crystal Serene Gray DeLite (001 LI50D)	Light Siam (227)
Chrysolite (238)	Crystal Silky Sage DeLite (001 LI47D)	Light Silk (261)
Citrus Green (337)	Crystal Silver Night (001 SINI)	Light Topaz (226)
Crystal (001)	Crystal Silver Shade (001 SSHA)	Light Topaz Shimmer (226 SHIM)
Crystal Aurore Boreale (001 AB)	Crystal Sky Ignite (001 LI63I)	Light Turquoise (263)
Crystal Bermuda Blue (001 BBL)	Crystal Vitrail Light (001 VL)	Montana (207)
Crystal Blue Shade (001 BLSH)	Crystal Vitrail Medium (001 VM)	Peridot (214)
Crystal Dusty Pink DeLite (001 LI49D)	Crystal Volcano (001 VOL)	Rosaline (508)
Crystal Flamingo Ignite (001 LI62I)	Denim Blue (266)	Rose (209)
Crystal Golden Shadow (001 GSHA)	Emerald (205)	Rose Peach (262)
Crystal Ignite (001 IGNIT)	Emerald Ignite (205 IGNIT)	Rose Water Opal (395)
Crystal Ivory Cream DeLite (001 LI06D)	Erinite (360)	Sapphire (206)
Crystal Laguna DeLite (001 LI42D)	Fuchsia (502)	Scarlet (276)
Crystal Lavender DeLite (001 LI44D)	Golden Topaz (1003)	Scarlet Ignite (276 IGNIT)
Crystal Linen Ignite (001 LI64I)	Iris (219)	Siam (208)
Crystal Lotus Pink DeLite (001 LI45D)	Jet (280)	Smoked Amber (1001)
Crystal Maroon Ignite (001 LI60I)	Jonquil (213)	Tanzanite (539)
Crystal Moonlight (001 MOL)	Light Amber (1002)	Vintage Rose (319)
Crystal Ocean DeLite (001 LI43D)	Light Amethyst (212)	Violet (371)
Crystal Orange Glow DeLite (001 LI46D)	Light Azore (361)	White Opal (234)
Crystal Orange Ignite (001 LI59I)	Light Colorado Topaz (246)	

For details on available colors and effects for each article within the product groups, please see the product matrix of the respective item in the Collection 2023.

The plating resistance of effects is tested according to Swarovski's plating guidelines (SWAROVSKI.COM/S-PROFESSIONALS). Customers are advised to carry out their own tests if their plating parameters diverge from Swarovski plating guidelines.

Colors and effects can appear different when illuminated with different light sources. Swarovski uses standard light source D65 for color decision and comparison. Slight changes in shades are unavoidable. Colors may vary according to cut and foiling.

The composition of Advanced Crystal is compliant with regulatory industry norms and laws regarding the restriction or prohibition of certain substances in the most relevant segments of our customers. Please note that the compliance of the colors Light Siam and Siam varies according to certain industry regulations. Those regulations are indicated with * in the compliance overview. Indian Siam, Ruby and Scarlet (option to Lt. Siam) conform to all CLEAR-lists. For further information please visit [swarovski.com/s-professionals](https://www.swarovski.com/s-professionals)

© 2023 D. Swarovski Distribution GmbH

Summary

1 2 3  4120 6x4, 8x6, 14x10, 18x13 mm	1 2 3  4327 30x20 mm	1 2 3  4500 3x2, 6x2 mm
 4127 30x22 mm	 4328 6x3.6, 8x4.8 mm	 4501 4x2, 5x2, 5x2.5, 7x3 mm
 4128 6x4, 8x6 mm	 4329 8x7, 10x8.7, 14x12.1 mm	 4502 3x1 mm
 4139 14, 20 mm	 4390 10x7, 14x10, 18x13 mm	 4527 8x6, 14x10, 18x13 mm
 4160 8x6, 10x8, 14x10, 18x13 mm	 4428 1.5, 2, 3, 4, 8 mm	 4547 15x5, 21x7 mm
 4161 15x5 mm	 4447 6, 8, 10, 12 mm	 4568 14x10, 18x13 mm
 4162 10x5.5, 14x7.5, 18x9.5 mm	 4460 8, 10, 14, 18 mm	 4600 6x4, 8x6, 10x8 mm
 4200 11x3, 15x4 mm	 4470 10, 12 mm	 4610 14x10, 18x13 mm
 4228 4x2, 5x2.5, 6x3, 8x4, 10x5, 15x7 mm	 4471 8, 10, 12 mm	 4627 27x18.5 mm
 4320 6x4, 8x6, 10x7, 14x10, 18x13 mm	 4480 6, 8, 10, 14, 18 mm	 4683 7.8x8.7, 10x11.2, 12x13.5, 14x15.8 mm
 4322 10x5 mm	 4483 8, 10, 12, 14 mm	 4706 7, 12, 17 mm

05

1 2 3

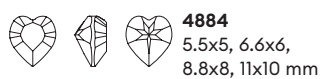
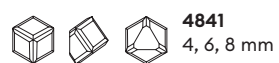

Summary

1 Top view 2 Side view 3 Back view

4120 Oval Fancy Stone



Size 6x4, 8x6, 14x10, 18x13 mm

4127 Big Oval Fancy Stone

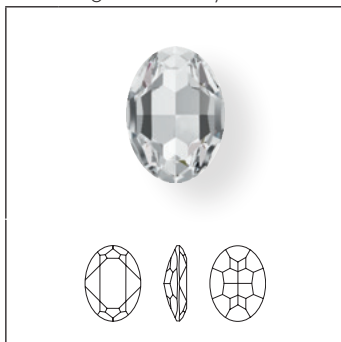







Size 30x22 mm

	4122 Big Oval Fancy Stone				4127 Big Oval Fancy Stone
	6x4 mm	8x6 mm	14x10 mm	18x13 mm	30x22 mm
Crystal					
Crystal F (001)	■	■	■	■	■
Colors					
Plain Colors					
Amethyst F (204)	■	■	■	■	■
Aquamarine F (202)	■	■	■	■	■
Black Diamond F (215)	■	■	■	■	■
Chrysolite F (238)	■	■	■	■	■
Citrus Green F (337)	■	■	■	■	■
Denim Blue F (266)	■	■	■	■	■
Emerald F (205)	■	■	■	■	■
Golden Topaz F (1003)*	■	■	■	■	■
Jet (280)	■	■	■	■	■
Light Amber F (1002)*	■	■	■	■	■
Light Amethyst F (212)	■	■	■	■	■
Light Azore F (361)	■	■	■	■	■
Light Colorado Topaz F (246)	■	■	■	■	■
Light Rose F (223)	■	■	■	■	■
Light Topaz F (226)	■	■	■	■	■
Light Turquoise F (263)	■	■	■	■	■
Montana F (207)	■	■	■	■	■
Peridot F (214)	■	■	■	■	■

* All colors with a 4-digit color code (i.e. Golden Topaz) are fully customizable with shorter lead times and lower MOQs compared to our 3-digit colors. Please get in touch with the Customer Service for a time and quantity estimation of your desired variant.

4120 4127		Size	4122 Big Oval Fancy Stone	6x4 mm	8x6 mm	14x10 mm	18x13 mm	4127 Big Oval Fancy Stone	30x22 mm
	Rose F (209)		■	■	■	■			
	Rose Peach F (262)		■	■	■	■			
	Sapphire F (206)		■	■	■	■			
	Scarlet F (276)		■	■	■	■			
	Siam F (208)		■	■	■	■			
	Smoked Amber F (1001)*		■	■	■	■			
	Tanzanite F (539)		■	■	■	■		■	
	Vintage Rose F (319)		■	■	■	■			
Opal Colors									
	White Opal F (234)		■	■	■	■			■
Crystal Effects									
Transparent Effects									
	Crystal Aurore Boreale F (001 AB)		■	■	■	■			■
	Crystal Golden Shadow F (001 GSHA)		■	■	■	■			■
	Crystal Ignite (001 IGNIT)			■	■	■			
	Crystal Moonlight F (001 MOL)		■	■	■	■			
	Crystal Silver Night F (001 SINI)		■	■	■	■			
	Crystal Silver Shade F (001 SSHA)		■	■	■	■			■
Crystal Lacquer^{PRO} Effects									
Crystal Lacquer^{PRO} Ignite Effects									
	Crystal Flamingo Ignite (001 L162I)				■	■			■
	Crystal Linen Ignite (001 L164I)				■	■			■
	Crystal Maroon Ignite (001 L160I)				■	■			■
	Crystal Orange Ignite (001 L159I)				■	■			■
	Crystal Purple Ignite (001 L161I)				■	■			■
	Crystal Sky Ignite (001 L163I)				■	■			■
Crystal Lacquer^{PRO} DeLite Effects									
	Crystal Dusty Pink DeLite (001 L149D)				■	■			■
	Crystal Ivory Cream DeLite (001 L106D)				■	■			■
	Crystal Lavender DeLite (001 L144D)				■	■			■
	Crystal Royal Blue DeLite (001 L110D)				■	■			■
	Crystal Serene Gray DeLite (001 L150D)				■	■			■

* All colors with a 4-digit color code (i.e. Golden Topaz) are fully customizable with shorter lead times and lower MOQs compared to our 3-digit colors. Please get in touch with the Customer Service for a time and quantity estimation of your desired variant.

<p>4120 4127</p>					
		Size			
		4122 Big Oval Fancy Stone			
		6x4 mm			
		8x6 mm			
		14x10 mm			
		18x13 mm			
		4127 Big Oval Fancy Stone			
		30x22 mm			
Color Effects					
Transparent Effects					
 Amethyst Ignite (204 IGNIT)			■	■	■
 Aquamarine Ignite (204 IGNIT)			■	■	■
 Emerald Ignite (205 IGNIT)			■	■	■
 Light Colorado Topaz Ignite (246 IGNIT)			■	■	■
 Light Rose Ignite (223 IGNIT)			■	■	■
 Scarlet Ignite (276 IGNIT)			■	■	■

4128 XILION Oval Fancy Stone



Crystal	
Crystal F (001)	<input type="checkbox"/>
Colors	
Plain Colors	
Amethyst F (204)	<input type="checkbox"/>
Aquamarine F (202)	<input type="checkbox"/>
Black Diamond F (215)	<input type="checkbox"/>
Emerald F (205)	<input type="checkbox"/>
Light Amethyst F (212)	<input type="checkbox"/>
Light Rose F (223)	<input type="checkbox"/>
Montana F (207)	<input type="checkbox"/>
Rose F (209)	<input type="checkbox"/>
Siam F (208)	<input type="checkbox"/>
Crystal Effects	
Transparent Effects	
Crystal Golden Shadow F (001 GSHA)	<input type="checkbox"/>

4139 Cosmic Ring Fancy Stone



Crystal	
Crystal (001)	<input type="checkbox"/>
Crystal Effects	
Transparent Effects	
Crystal Aurore Boreale (001 AB)	<input type="checkbox"/>
Crystal Bermuda Blue (001 BB)	<input type="checkbox"/>
Crystal Golden Shadow (001 GSHA)	<input type="checkbox"/>
Crystal Silver Night (001 SINI)	<input type="checkbox"/>
Crystal Vitrail Light (001 VL)	<input type="checkbox"/>
Crystal Vitrail Medium (001 VM)	<input type="checkbox"/>
Crystal Volcano (001 VOL)	<input type="checkbox"/>
Metallic Effects	
Crystal Comet Argent Light V SI (001 CAVSI)	<input type="checkbox"/>

4160 Mystic Oval Fancy Stone



Crystal

Crystal F (001)

Crystal Effects

Transparent Effects

Crystal Aurore Boreale F (001 AB)

Crystal Paradise Shine F (001 PARSH)

Crystal Vitrail Medium F (001 VM)

Crystal Lacquer^{PRO} Effects

Crystal Flamingo Ignite (001 L162I)

Crystal Linen Ignite (001 L164I)

Crystal Maroon Ignite (001 L160I)

Crystal Orange Ignite (001 L159I)

Crystal Purple Ignite (001 L161I)

Crystal Sky Ignite (001 L163I)

4161 Long Classic Oval Fancy Stone

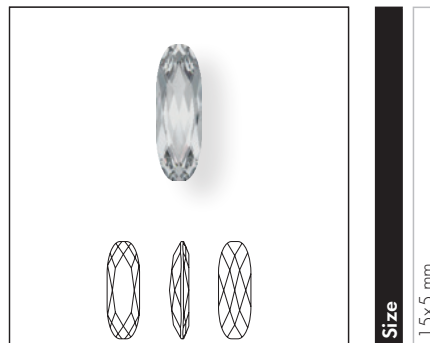

Crystal

Crystal F (001)

4162 Elongated Oval Fancy Stone

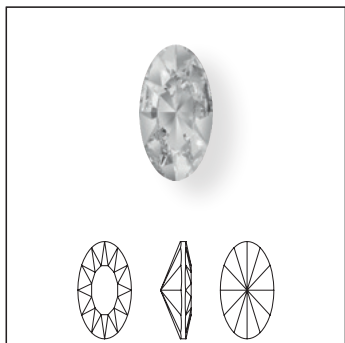

Size
10x5.5 mm
14x7.5 mm
18x9.5 mm

Crystal	10x5.5 mm	14x7.5 mm	18x9.5 mm
Crystal F (001)	■	■	■
Colors			
Plain Colors			
Aquamarine F (202)	■	■	■
Black Diamond F (215)	■	■	■
Emerald F (205)	■	■	■
Iris F (219)	■	■	■
Jet (280)	■	■	■
Light Colorado Topaz F (246)	■	■	■
Montana F (207)	■	■	■
Scarlet F (276)	■	■	■
Vintage Rose F (319)	■	■	■
Crystal Effects			
Transparent Effects			
Crystal Aurore Boreale F (001 AB)	■	■	■
Crystal Golden Shadow F (001 GSHA)	■	■	■
Crystal Silver Shade F (001 SSHA)	■	■	■

4200 Sphinx Eye Fancy Stone

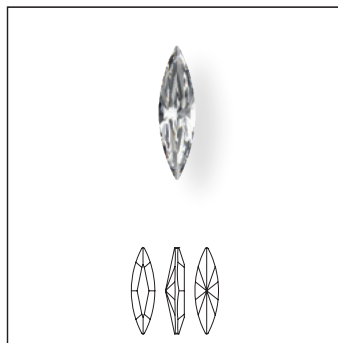

Size
11x3 mm
15x4 mm

Crystal	11x3 mm	15x4 mm
Crystal F (001)	■	■
Crystal Effects		
Transparent Effects		
Crystal Aurore Boreale F (001 AB)	■	■
Crystal Golden Shadow F (001 GSHA)	■	■

4228 XILION Navette Fancy Stone

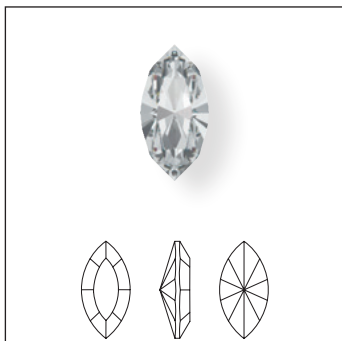





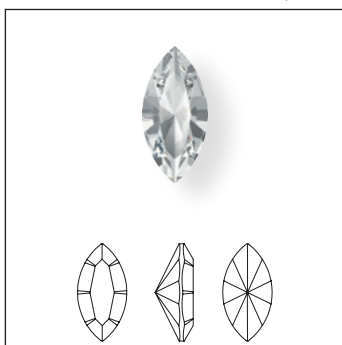



Size 4x2, 5x2.5 mm

4228 XILION Navette Fancy Stone



Size 6x3, 8x4, 10x5, 15x7 mm

4228	Size					
	4x2 mm	5x2.5 mm	6x3 mm	8x4 mm	10x5 mm	15x7 mm
Crystal						
Crystal F (001)	■	■	■	■	■	■
Colors						
Plain Colors						
Amethyst F (204)	■	■	■	■	■	■
Aquamarine F (202)	■	■	■	■	■	■
Black Diamond F (215)	■	■	■	■	■	■
Chrysolite F (238)	■	■	■	■	■	■
Citrus Green F (337)	■	■	■	■	■	■
Denim Blue F (266)	■	■	■	■	■	■
Emerald F (205)	■	■	■	■	■	■
Golden Topaz F (1003)	■	■	■	■	■	■
Jet (280)	■	■	■	■	■	■
Light Amber F (1002)	■	■	■	■	■	■
Light Amethyst F (212)	■	■	■	■	■	■
Light Colorado Topaz F (246)	■	■	■	■	■	■
Light Rose F (223)	■	■	■	■	■	■
Light Sapphire F (211)	■	■	■	■	■	■
Light Siam F (227)	■	■	■	■	■	■
Light Silk F (261)	■	■	■	■	■	■
Light Topaz F (226)	■	■	■	■	■	■
Light Turquoise F (263)	■	■	■	■	■	■
Montana F (207)	■	■	■	■	■	■
Peridot F (214)	■	■	■	■	■	■
Rose F (209)	■	■	■	■	■	■
Rose Peach F (262)	■	■	■	■	■	■
Sapphire F (206)	■	■	■	■	■	■
Scarlet F (276)	■	■	■	■	■	■
Siam F (208)	■	■	■	■	■	■
Smoked Amber F (1001)	■	■	■	■	■	■
Tanzanite F (539)	■	■	■	■	■	■
Opal Colors						
White Opal F (234)	■	■	■	■	■	■
Crystal Effects						
Transparent Effects						
Crystal Aurore Boreale F (001 AB)	■	■	■	■	■	■
Crystal Golden Shadow F (001 GSHA)	■	■	■	■	■	■
Crystal Moonlight F (001 MOL)	■	■	■	■	■	■
Crystal Silver Night F (001 SINI)	■	■	■	■	■	■
Crystal Silver Shade F (001 SSHA)	■	■	■	■	■	■

4228								
		Size	4x2 mm	5x2.5 mm	6x3 mm	8x4 mm	10x5 mm	15x7 mm
Crystal Lacquer^{PRO} Effects								
	Crystal Dusty Pink Delite (001 L149D)						■	
	Crystal Ivory Cream Delite (001 L106D)						■	
	Crystal Lavender Delite (001 L144D)						■	
	Crystal Maroon Ignite (001 L160I)						■	
	Crystal Orange Ignite (001 L159I)						■	
	Crystal Purple Ignite (001 L161I)						■	
	Crystal Royal Blue Delite (001 L110D)						■	
	Crystal Serene Gray Delite (001 L150D)						■	

4320 Pear Fancy Stone

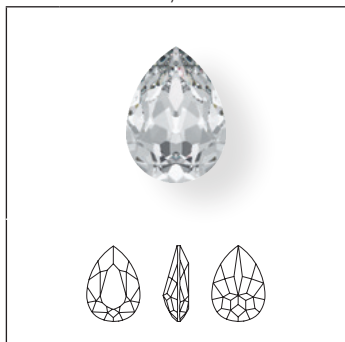

Size 6x4, 8x6, 10x7, 14x10, 18x13 mm

4327 Large Pear Fancy Stone



Size 30x20 mm

	6x4 mm	8x6 mm	10x7 mm	14x10 mm	18x13 mm	30x20 mm
4320 4327						
Crystal						
Crystal F (001)	■	■	■	■	■	■
Colors						
Plain Colors						
Amethyst F (204)	■	■	■	■	■	■
Aquamarine F (202)	■	■	■	■	■	■
Black Diamond F (215)	■	■	■	■	■	■
Chrysolite F (238)	■	■	■	■	■	■
Citrus Green F (337)	■	■	■	■	■	■
Denim Blue F (266)	■	■	■	■	■	■
Emerald F (205)	■	■	■	■	■	■
Golden Topaz F (1003)*	■	■	■	■	■	■
Iris F (219)	■	■	■	■	■	■
Jet (280)	■	■	■	■	■	■
Light Amber F (1002)*	■	■	■	■	■	■
Light Amethyst F (212)	■	■	■	■	■	■
Light Colorado Topaz F (246)	■	■	■	■	■	■
Light Rose F (223)	■	■	■	■	■	■
Light Silk F (261)	■	■	■	■	■	■
Light Topaz F (226)	■	■	■	■	■	■
Light Turquoise F (263)	■	■	■	■	■	■
Montana F (207)	■	■	■	■	■	■
Peridot F (214)	■	■	■	■	■	■

* All colors with a 4-digit color code (i.e. Golden Topaz) are fully customizable with shorter lead times and lower MOQs compared to our 3-digit colors. Please get in touch with the Customer Service for a time and quantity estimation of your desired variant.

4320 4327		Size	4320 Pear Fancy Stone	6x4 mm	8x6 mm	10x7 mm	14x10 mm	18x13 mm	4327 Large Pear Fancy Stone	30x20 mm
	Rose F (209)		■	■	■	■	■	■		
	Rose Peach F (262)		■	■	■	■	■	■		
	Sapphire F (206)		■	■	■	■	■	■		
	Scarlet F (276)		■	■	■	■	■	■		
	Siam F (208)		■	■	■	■	■	■		
	Smoked Amber F (1001)*		■	■	■	■	■	■		
	Tanzanite F (539)		■	■	■	■	■	■	■	
	Vintage Rose F (319)		■	■	■	■	■	■		
Opal Colors										
	White Opal F (234)		■	■	■	■	■	■	■	
Crystal Effects										
Transparent Effects										
	Crystal Aurore Boreale F (001 AB)		■	■	■	■	■	■	■	
	Crystal Golden Shadow F (001 GSHA)		■	■	■	■	■	■	■	
	Crystal Ignite (001 IGNIT)			■	■	■	■	■		
	Crystal Moonlight F (001 MOL)		■	■	■	■	■	■		
	Crystal Silver Night F (001 SINI)		■	■	■	■	■	■		
	Crystal Silver Shade F (001 SSHA)		■	■	■	■	■	■	■	
Crystal Lacquer^{PRO} Effects										
Crystal Lacquer^{PRO} Ignite Effects										
	Crystal Flamingo Ignite (001 L1621)					■	■	■	■	
	Crystal Linen Ignite (001 L1641)					■	■	■	■	
	Crystal Maroon Ignite (001 L1601)					■	■	■	■	
	Crystal Orange Ignite (001 L1591)					■	■	■	■	
	Crystal Purple Ignite (001 L1611)					■	■	■	■	
	Crystal Sky Ignite (001 L1631)					■	■	■	■	

* All colors with a 4-digit color code (i.e. Golden Topaz) are fully customizable with shorter lead times and lower MOQs compared to our 3-digit colors. Please get in touch with the Customer Service for a time and quantity estimation of your desired variant.

4320 4327		Size	4320 Pear Fancy Stone	6x4 mm	8x6 mm	10x7 mm	14x10 mm	18x13 mm	4327 Large Pear Fancy Stone	30x20 mm	
Crystal Lacquer^{PRO} DeLite Effects											
	Crystal Dusty Pink DeLite (001 L149D)						■	■	■		
	Crystal Ivory Cream DeLite (001 L106D)						■	■	■		
	Crystal Laguna DeLite (001 L142D)						■	■	■		
	Crystal Lavender DeLite (001 L144D)						■	■	■		
	Crystal Ocean DeLite (001 L143D)						■	■	■		
	Crystal Royal Blue DeLite (001 L110D)						■	■	■		
	Crystal Serene Gray DeLite (001 L150D)						■	■	■		
	Crystal Silky Sage DeLite (001 L147D)						■	■	■		
Color Effects											
Transparent Effects											
	Amethyst Ignite (204 IGNIT)			■	■	■	■				
	Aquamarine Ignite (204 IGNIT)			■	■	■	■				
	Emerald Ignite (205 IGNIT)			■	■	■	■				
	Light Colorado Topaz Ignite (246 IGNIT)			■	■	■	■				
	Light Rose Ignite (223 IGNIT)			■	■	■	■				
	Scarlet Ignite (276 IGNIT)			■	■	■	■				

4322 Teardrop Fancy Stone

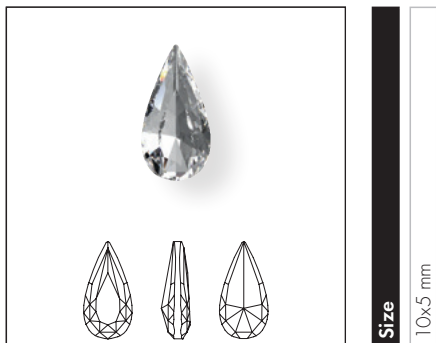

Size

10x5 mm

Crystal

Crystal F (001)

Colors

Plain Colors

Vintage Rose F (319)

Crystal Effects

Transparent Effects

Crystal Aurore Boreale F (001 AB)

Crystal Golden Shadow F (001 GSHA)

Crystal Silver Shade F (001 SSHA)

4328 XILLION Pear Fancy Stone



Size

6x3.6 mm

8x4.8 mm

Crystal

Crystal F (001)

Colors

Plain Colors

Aquamarine F (202)

Black Diamond F (215)

Emerald F (205)

Light Rose F (223)

Siam F (208)

Crystal Effects

Transparent Effects

Crystal Golden Shadow F (001 GSHA)

4329 Majestic Fancy Stone



Crystal	8x7 mm	10x8.7 mm	14x12.1 mm
Crystal F (001)	■	■	■
Colors			
Plain Colors			
Amethyst F (204)	■	■	■
Aquamarine F (202)	■	■	■
Citrus Green F (337)	■	■	■
Emerald F (205)	■	■	■
Golden Topaz F (1003)	■	■	■
Jonquil F (213)	■	■	■
Light Amber F (1002)	■	■	■
Light Rose F (223)	■	■	■
Montana F (207)	■	■	■
Scarlet F (276)	■	■	■
Crystal Effects			
Transparent Effects			
Crystal Golden Shadow F (001 GSHA)	■	■	■
Crystal Ignite (001 IGNIT)	■	■	■
Crystal Silver Night (001 SINI)	■	■	■
Color Effects			
Transparent Effects			
Amethyst Ignite (204 IGNIT)	■	■	■
Aquamarine Ignite (202 IGNIT)	■	■	■
Emerald Ignite (205 IGNIT)	■	■	■
Light Rose Ignite (223 IGNIT)	■	■	■
Scarlet Ignite (276 IGNIT)	■	■	■

4390 Mirage Pear Fancy Stone

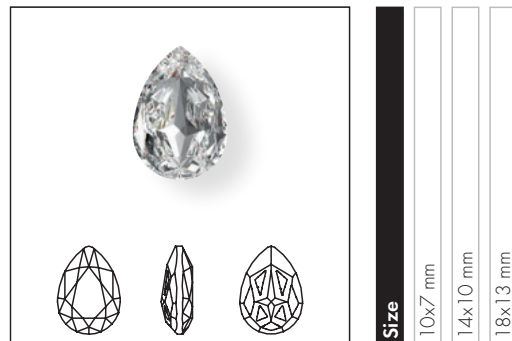

Crystal	10x7 mm	14x10 mm	18x13 mm
Crystal F (001)	■	■	■
Colors			
Plain Colors			
Amethyst F (204)	■	■	■
Aquamarine F (202)	■	■	■
Black Diamond F (215)	■	■	■
Emerald F (205)	■	■	■
Light Colorado Topaz F (246)	■	■	■
Light Rose F (223)	■	■	■
Montana F (207)	■	■	■
Scarlet F (276)	■	■	■
Crystal Effects			
Transparent Effects			
Crystal Aurore Boreale F (001 AB)	■	■	■
Crystal Paradise Shine F (001 PARSH)	■	■	■
Crystal Silver Night F (001 SINI)	■	■	■
Crystal Vitrail Medium F (001 VM)	■	■	■

4428 XILION Square Fancy Stone

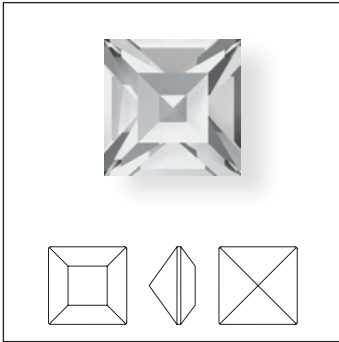

Size 1.5, 2 mm

4428 XILION Square Fancy Stone

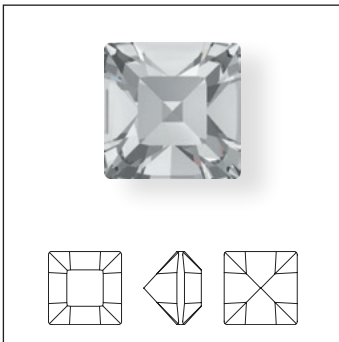

Size 3, 4 mm

4428 XILION Square Fancy Stone

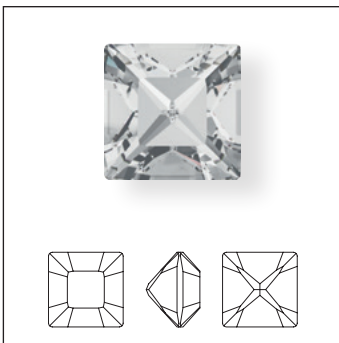

Size 8 mm

4428	Size	1.5 mm	2 mm	3 mm	4 mm	8 mm
Crystal						
Crystal F (001)		■	■	■	■	■
Colors						
Plain Colors						
Amethyst F (204)		■	■	■	■	■
Aquamarine F (202)		■	■	■	■	■
Black Diamond F (215)		■	■	■	■	■
Citrus Green F (337)		■	■	■	■	■
Emerald F (205)		■	■	■	■	■
Jet (280)		■	■	■	■	■
Jet F (280)		■	■	■	■	■
Light Amethyst F (212)		■	■	■	■	■
Light Colorado Topaz F (246)		■	■	■	■	■
Light Rose F (223)		■	■	■	■	■
Light Sapphire F (211)		■	■	■	■	■
Light Siam F (227)		■	■	■	■	■
Light Topaz F (226)		■	■	■	■	■
Light Turquoise F (263)		■	■	■	■	■
Montana F (207)		■	■	■	■	■
Peridot F (214)		■	■	■	■	■
Rose F (209)		■	■	■	■	■
Rose Peach F (262)		■	■	■	■	■
Sapphire F (206)		■	■	■	■	■
Scarlet F (276)		■	■	■	■	■
Siam F (208)		■	■	■	■	■
Tanzanite F (539)		■	■	■	■	■
Crystal Effects						
Transparent Effects						
Crystal Aurore Boreale F (001 AB)		■	■	■	■	■
Crystal Golden Shadow F (001 GSHA)		■	■	■	■	■
Crystal Silver Night F (001 SINI)		■	■	■	■	■
Crystal Silver Shade F (001 SSHA)		■	■	■	■	■

4447 Princess Square Fancy Stone



Size
6 mm
8 mm
10 mm
12 mm

Crystal
Crystal F (001)

4460 Mystic Square Fancy Stone

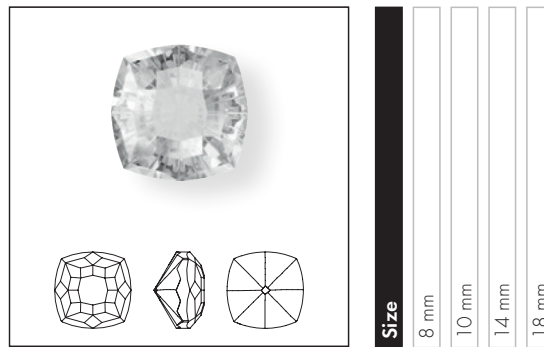

Size
8 mm
10 mm
14 mm
18 mm

Crystal
Crystal F (001)

Colors

Plain Colors

- Amethyst F (204)
- Aquamarine F (202)
- Emerald F (205)
- Iris F (219)
- Light Colorado Topaz F (246)
- Scarlet F (276)

Crystal Effects

Transparent Effects

- Crystal Aurore Boreale F (001 AB)
- Crystal Paradise Shine F (001 PARSH)
- Crystal Vitrail Medium F (001 VM)

Crystal Lacquer^{PRO} Effects

- Crystal Flamingo Ignite (001 L162I)
- Crystal Linen Ignite (001 L164I)
- Crystal Maroon Ignite (001 L160I)
- Crystal Orange Ignite (001 L159I)
- Crystal Purple Ignite (001 L161I)
- Crystal Sky Ignite (001 L163I)

Color Effects

Transparent Effects

- Light Topaz Shimmer F (226 SHIM)

05

4470 Cushion Square Fancy Stone

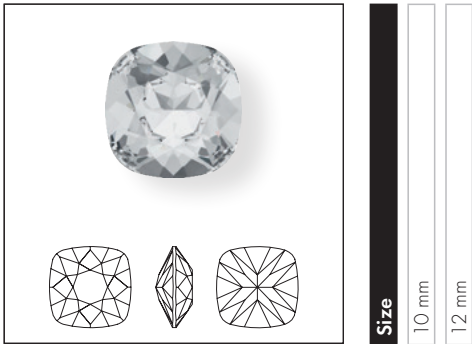

Size
10 mm
12 mm

Crystal

Crystal F (001)

Colors

Plain Colors

Amethyst F (204)

Aquamarine F (202)

Black Diamond F (215)

Chrysolite F (238)

Citrus Green F (337)

Denim Blue F (266)

Emerald F (205)

Golden Topaz F (1003)

Iris F (219)

Jet (280)

Light Amber F (1002)

Light Amethyst F (212)

Light Azure F (361)

Light Colorado Topaz F (246)

Light Rose F (223)

Light Sapphire F (211)

Light Siam F (227)

Light Topaz F (226)

Light Turquoise F (263)

Peridot F (214)

Rose Peach F (262)

Sapphire F (206)

Scarlet F (276)

Siam F (208)

Smoked Amber F (1001)

Tanzanite F (539)

Vintage Rose F (319)

Opal Colors

White Opal F (234)

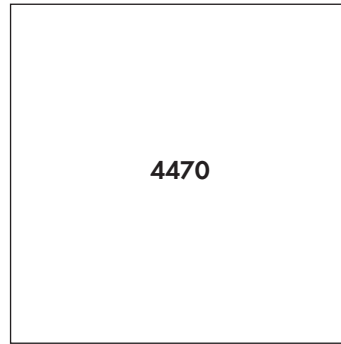

Size
10 mm
12 mm

Crystal Effects

Transparent Effects

Crystal Aurore Boreale F (001 AB)

Crystal Bermuda Blue F (001 BB)

Crystal Golden Shadow F (001 GSHA)

Crystal Ignite (001 IGNIT)

Crystal Moonlight F (001 MOL)

Crystal Silver Night F (001 SINI)

Crystal Silver Shade F (001 SSHA)

Crystal Lacquer^{PRO} Effects

Crystal Dusty Pink DeLite (001 L149D)

Crystal Flamingo Ignite (001 L162I)

Crystal Ivory Cream DeLite (001 L106D)

Crystal Laguna DeLite (001 L142D)

Crystal Lavender DeLite (001 L144D)

Crystal Linen Ignite (001 L164I)

Crystal Lotus Pink DeLite (001 L145D)

Crystal Maroon Ignite (001 L160I)

Crystal Ocean DeLite (001 L143D)

Crystal Orange Glow DeLite (001 L146D)

Crystal Orange Ignite (001 L159I)

Crystal Purple Ignite (001 L161I)

Crystal Royal Blue DeLite (001 L110D)

Crystal Royal Red DeLite (001 L107D)

Crystal Serene Gray DeLite (001 L150D)

Crystal Silky Sage DeLite (001 L147D)

Crystal Sky Ignite (001 L163I)

Color Effects

Transparent Effects

Amethyst Ignite (204 IGNIT)

Aquamarine Ignite (202 IGNIT)

Emerald Ignite (205 IGNIT)

Light Colorado Topaz Ignite (246 IGNIT)

Light Rose Ignite (223 IGNIT)

Scarlet Ignite (276 IGNIT)

4471 Rose Cut Cushion Fancy Stone



Size
8 mm
10 mm
12 mm

Crystal	8 mm	10 mm	12 mm
Crystal F (001)	■	■	■
Colors			
Plain Colors			
Vintage Rose F (319)	■	■	■
Opal Colors			
Rose Water Opal F (395)	■	■	■
White Opal F (234)	■	■	■
Crystal Effects			
Transparent Effects			
Crystal Aurore Boreale F (001 AB)	■	■	■
Crystal Golden Shadow F (001 GSHA)	■	■	■

4480 Imperial Fancy Stone



Size
6 mm
8 mm
10 mm
14 mm
18 mm

Crystal	6 mm	8 mm	10 mm	14 mm	18 mm
Crystal F (001)	■	■	■	■	■
Colors					
Plain Colors					
Amethyst F (204)	■	■	■	■	■
Aquamarine F (202)	■	■	■	■	■
Emerald F (205)	■	■	■	■	■
Jet (280)	■	■	■	■	■
Light Colorado Topaz F (246)	■	■	■	■	■
Light Rose F (223)	■	■	■	■	■
Montana F (207)	■	■	■	■	■
Scarlet F (276)	■	■	■	■	■
Crystal Effects					
Transparent Effects					
Crystal Aurore Boreale F (001 AB)	■	■	■	■	■
Crystal Golden Shadow F (001 GSHA)	■	■	■	■	■
Crystal Silver Night (001 SINI)	■	■	■	■	■
Crystal Silver Shade F (001 SSHA)	■	■	■	■	■

4483 Fantasy Cushion Fancy Stone



	8 mm	10 mm	12 mm	14 mm
Crystal				
Crystal F (001)	■	■	■	■
Colors				
Plain Colors				
Vintage Rose F (319)	■	■	■	■
Crystal Effects				
Transparent Effects				
Crystal Golden Shadow F (001 GSHA)	■	■	■	■
Crystal Silver Night (001 SINI)	■	■	■	■
Crystal Lacquer^{PRO} Effects				
Crystal Flamingo Ignite (001 L162I)	■	■	■	■
Crystal Linen Ignite (001 L164I)	■	■	■	■
Crystal Sky Ignite (001 L163I)	■	■	■	■

4500 Thin Baguette Fancy Stone

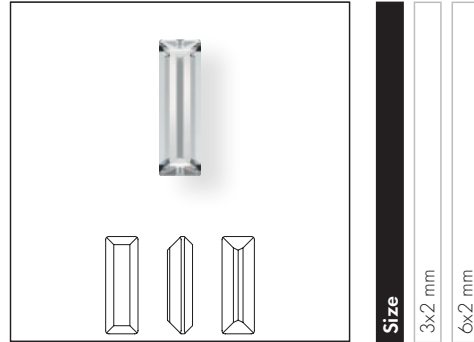

	3x2 mm	6x2 mm
Crystal		
Crystal (001)	■	■
Crystal F (001)	■	■

4501 Baguette Fancy Stone

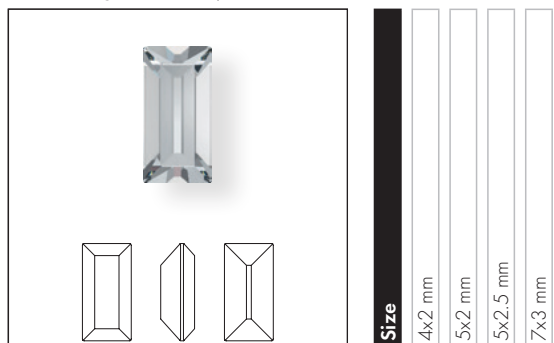

Size
4x2 mm
5x2 mm
5x2.5 mm
7x3 mm

Crystal

Crystal F (001)

Colors

Plain Colors

- Amethyst F (204)
- Aquamarine F (202)
- Black Diamond F (215)
- Citrus Green F (337)
- Emerald F (205)
- Jet (280)
- Light Amethyst F (212)
- Light Colorado Topaz F (246)
- Light Rose F (223)
- Light Sapphire F (211)
- Light Topaz F (226)
- Light Turquoise F (263)
- Montana F (207)
- Peridot F (214)
- Rose F (209)
- Sapphire F (206)
- Scarlet F (276)
- Siam F (208)
- Tanzanite F (539)

Crystal Effects

Transparent Effects

- Crystal Aurore Boreale F (001 AB)
- Crystal Golden Shadow F (001 GSHA)
- Crystal Silver Night F (001 SINI)
- Crystal Silver Shade F (001 SSHA)

4502 Small Baguette Fancy Stone

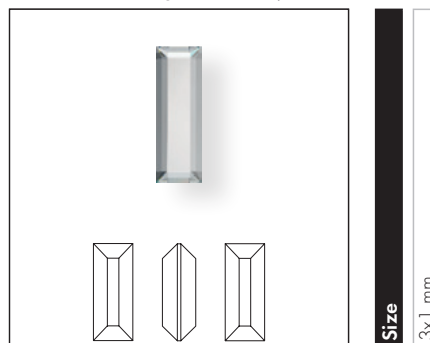

Size
3x1 mm

Crystal

Crystal (001)

Crystal F (001)

4527 Step Cut Fancy Stone

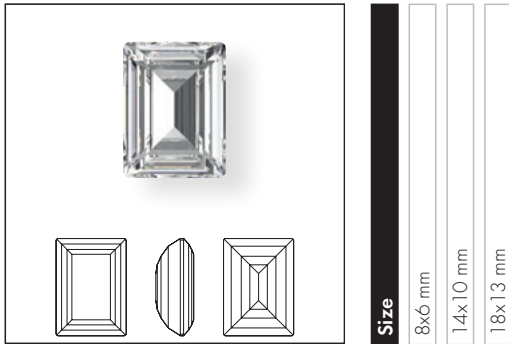

Size
8x6 mm
14x10 mm
18x13 mm

Crystal

Crystal F (001)

Colors

Plain Colors

Erinite F (360)

Light Amethyst F (212)

Montana F (207)

Tanzanite F (539)

Crystal Effects

Transparent Effects

Crystal Golden Shadow F (001 GSHA)

Crystal Moonlight F (001 MOL)

4547 Princess Baguette Fancy Stone

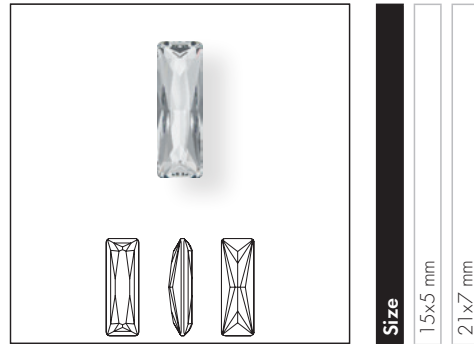

Size
15x5 mm
21x7 mm

Crystal

Crystal F (001)

4568 Cushion Fancy Stone

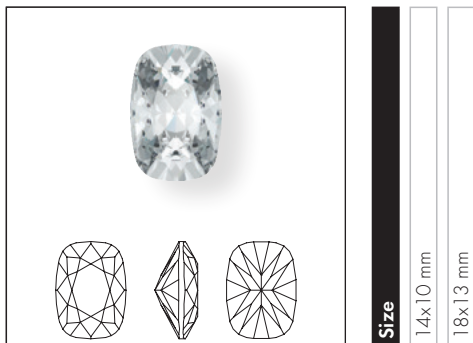

Size
14x10 mm
18x13 mm

- Crystal**
- Crystal F (001)
- Crystal Effects**
- Transparent Effects**
- Crystal Golden Shadow F (001 GSHA)
- Crystal Silver Night (001 SINI)
- Crystal Silver Shade F (001 SSHA)

4600 Octagon Fancy Stone

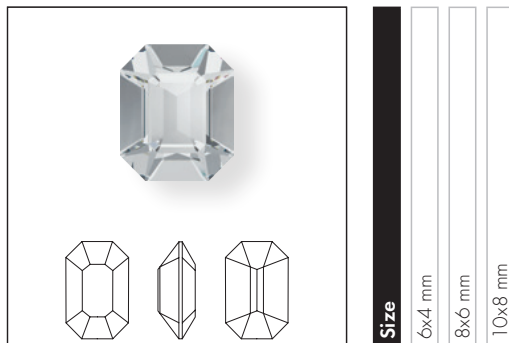

Size
6x4 mm
8x6 mm
10x8 mm

- Crystal**
- Crystal F (001)
- Crystal Effects**
- Transparent Effects**
- Crystal Golden Shadow F (001 GSHA)
- Crystal Silver Shade F (001 SSHA)

4610 Curved Back Octagon Fancy Stone



Size 14x10, 18x13 mm

4627 Thin Octagon Fancy Stone

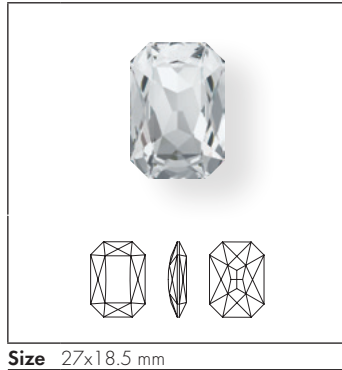

Size 27x18.5 mm

	4610 4627	4610 Curved Back Octagon F. Stone 14x10 mm	18x13 mm	4627 Thin Octagon Fancy Stone 27x18.5 mm
Crystal				
Crystal F (001)		■	■	■
Colors				
Plain Colors				
Amethyst F (204)		■	■	■
Aquamarine F (202)		■	■	■
Black Diamond F (215)		■	■	■
Emerald F (205)		■	■	■
Jet (280)		■	■	■
Light Colorado Topaz F (246)		■	■	■
Montana F (207)		■	■	■
Peridot F (214)		■	■	■
Siam F (208)		■	■	■
Tanzanite F (539)		■	■	■
Crystal Effects				
Transparent Effects				
Crystal Golden Shadow F (001 GSHA)		■	■	■
Crystal Silver Shade F (001 SSHA)		■	■	■
Crystal Lacquer^{PRO} Effects				
Crystal Lacquer^{PRO} Ignite Effects				
Crystal Flamingo Ignite (001 L1621)				■
Crystal Linen Ignite (001 L1641)				■
Crystal Sky Ignite (001 L1631)				■

4683 Fantasy Hexagon Fancy Stone



Size

7.8x8.7 mm
10x11.2 mm
12x13.5 mm
14x15.8 mm

Crystal

Crystal F (001)

Colors

Plain Colors

Vintage Rose F (319)

Crystal Effects

Transparent Effects

Crystal Golden Shadow F (001 GSHA)

Crystal Silver Night (001 SINI)

4706 Trilliant Fancy Stone



Size

7 mm
12 mm
17 mm

Crystal

Crystal F (001)

Colors

Plain Colors

Amethyst F (204)

Aquamarine F (202)

Light Colorado Topaz F (246)

Rose F (209)

Scarlet F (276)

Tanzanite F (539)

Vintage Rose F (319)

Crystal Effects

Transparent Effects

Crystal Aurore Boreale F (001 AB)

Crystal Blue Shade F (001 BLSH)

Crystal Golden Shadow F (001 GSHA)

Crystal Silver Night (001 SINI)

Crystal Silver Shade F (001 SSHA)

Crystal Volcano F (001 VOL)

4722 Triangle Fancy Stone

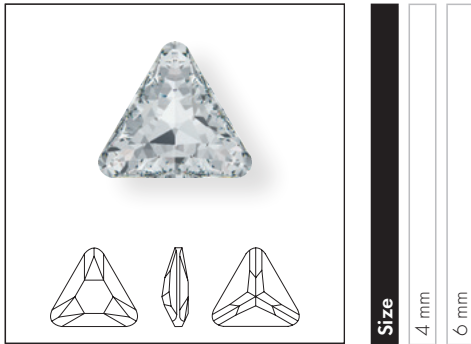

Size
4 mm
6 mm

Crystal

Crystal F (001)

4744 Rivoli Flower Fancy Stone

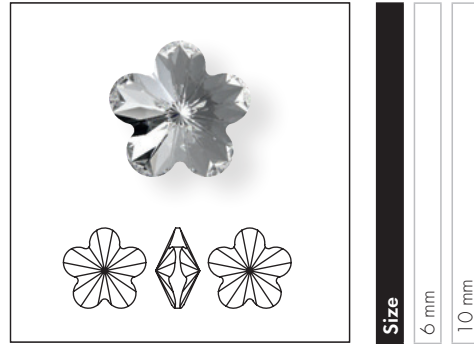

Size
6 mm
10 mm

Crystal

Crystal F (001)

Colors

Plain Colors

Aquamarine F (202)

Fuchsia F (502)

Light Rose F (223)

Violet F (371)

Crystal Effects

Transparent Effects

Crystal Aurore Boreale F (001 AB)

4745 Rivoli Star Fancy Stone



Size
5 mm
10 mm

- Crystal**
- Crystal F (001)
- Colors**
- Plain Colors**
- Jet (280)
- Crystal Effects**
- Transparent Effects**
- Crystal Aurore Boreale F (001 AB)
- Crystal Bermuda Blue F (001 BB)
- Crystal Golden Shadow F (001 GSHA)
- Crystal Silver Shade F (001 SSHA)
- Crystal Vitrail Light F (001 VL)
- Crystal Vitrail Medium F (001 VM)

4809 Sweet Heart Fancy Stone

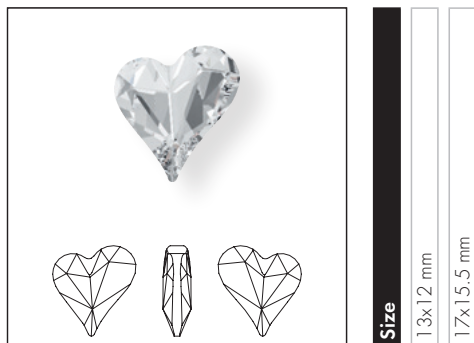

Size
13x12 mm
17x15.5 mm

- Crystal**
- Crystal F (001)
- Colors**
- Plain Colors**
- Amethyst F (204)
- Light Siam F (227)
- Rosaline F (508)
- Rose F (209)
- Rose Peach F (262)
- Violet F (371)
- Crystal Effects**
- Transparent Effects**
- Crystal Aurore Boreale F (001 AB)
- Crystal Blue Shade F (001 BLSH)
- Crystal Golden Shadow F (001 GSHA)
- Crystal Silver Night (001 SINI)

4841 Cube Fancy Stone

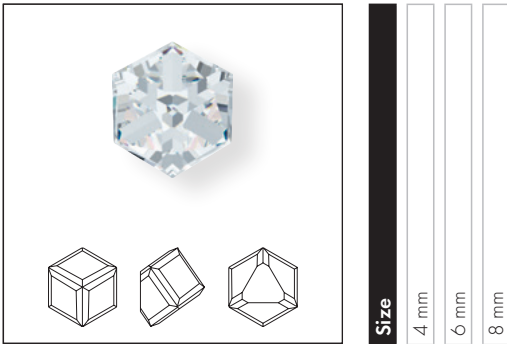

	4 mm	6 mm	8 mm
Crystal			
Crystal Comet Argent Light V Z (001 CAVZ)	■	■	■
Crystal Effects			
Transparent Effects			
Crystal Aurore Boreale CAL V Z (001 ABCVZ)	■	■	■
Crystal Vitrail Light Z (001 VLZ)	■	■	■
Crystal Vitrail Medium Z (001 VMZ)	■	■	■
Crystal Bermuda Blue Z (001 BBZ)	■	■	■
Crystal Golden Shadow CAL V Z (001 GSCVZ)	■	■	■
Color Effects			
Aquamarine Comet Argent Light V Z (202 CAVZ)	■	■	■
Light Rose Comet Argent Light V Z (223 CAVZ)	■	■	■
Light Siam Comet Argent Light V Z (227 CAVZ)	■	■	■

4869 Disco Fancy Stone

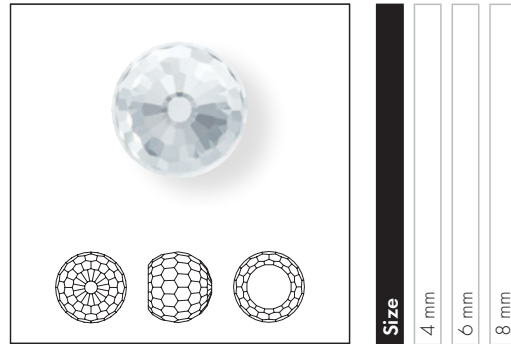

	4 mm	6 mm	8 mm
Crystal			
Crystal Comet Argent Light V Z (001 CAVZ)	■	■	■
Crystal Effects			
Transparent Effects			
Crystal Aurore Boreale CAL V Z (001 ABCVZ)	■	■	■
Crystal Vitrail Medium Z (001 VMZ)	■	■	■

4884 XILION Heart Fancy Stone



Size
5.5x5 mm
6.6x6 mm
8.8x8 mm
11x10 mm

Crystal

Crystal F (001)

Colors

Plain Colors

Aquamarine F (202)

Light Amethyst F (212)

Light Rose F (223)

Light Siam F (227)

Peridot F (214)

Rose F (209)

Crystal F (001)	■	■	■	■
Aquamarine F (202)	■	■	■	
Light Amethyst F (212)	■	■	■	
Light Rose F (223)	■	■	■	
Light Siam F (227)	■	■	■	
Peridot F (214)	■	■	■	
Rose F (209)	■	■	■	

Product Details

Article Size	Packing Unit = Minimum Order Quantity in Pieces	Average Net Weight in Gram per Packing Unit Crystal (001)	Average Gross Weight in Gram per Packing Unit Crystal (001)
4120			
6x4 mm	360	31.2	42.1
8x6 mm	180	44.7	45.2
14x10 mm	144	170.2	193.8
18x13 mm	48	112.3	132.9
4127			
30x22 mm	24	173.6	218.7
4128			
6x4 mm	360	26.8	37.6
8x6 mm	360	76.5	87.3
4139			
14 mm	72	53.2	82.7
20 mm	24	46.7	78.7
4160			
8x6 mm	90	23.9	43.5
10x8 mm	72	40.1	59.8
14x10 mm	48	65.9	85.6
18x13 mm	24	70.7	90.3
4161			
15x5 mm	72	29.5	51.6
4162			
10x5.5 mm	144	23.8	34.9
14x7.5 mm	72	36.0	56.4
18x9.5 mm	48	49.6	70.5
4200			
11x3 mm	360	28.6	39.4
15x4 mm	144	26.2	37.1
4228			
4x2 mm	720	9.2	18.3
5x2.5 mm	720	18.9	28.0
6x3 mm	720	30.5	39.6
8x4 mm	360	32.9	42.0
10x5 mm	360	60.7	72.1
15x7 mm	144	63.9	88.1
4320			
6x4 mm	360	25.7	34.8
8x6 mm	180	30.7	39.8
10x7 mm	144	48.6	68.9
14x10 mm	144	126.6	150.2
18x13 mm	48	85.2	105.8
4322			
10x5 mm	72	13.95	33.93
4327			
30x20 mm	24	161.8	206.8
4328			
6x3.6 mm	720	40.0	50.5
8x4.8 mm	360	42.1	53.0

Article Size	Packing Unit = Minimum Order Quantity in Pieces	Average Net Weight in Gram per Packing Unit Crystal (001)	Average Gross Weight in Gram per Packing Unit Crystal (001)
4329			
8x7 mm	90	23.9	45.3
10x8.7 mm	72	30.5	48.9
14x12.1 mm	24	26.5	47.2
4390			
10x7 mm	144	45.3	70.4
14x10 mm	144	125.4	150.9
18x13 mm	48	87.4	111.8
4428			
1.5 mm	1,440	4.32	15.1
2 mm	1,440	12.2	23.0
3 mm	1,440	34.8	57.6
4 mm	1,440	108.5	119.5
8 mm	144	84.5	99.6
4447			
6 mm	360	87.5	98.3
8 mm	144	71.5	91.9
10 mm	144	133.9	157.2
12 mm	72	117.6	137.9
4460			
8 mm	72	32.1	49.2
10 mm	48	41.1	58.8
14 mm	24	55.1	70.4
18 mm	15	70.5	88.7
4470			
10 mm	144	91.6	111.9
12 mm	72	74.7	92.9
4471			
8 mm	144	41.3	66.4
10 mm	96	54.3	77.5
12 mm	48	43.3	67.6
4480			
6 mm	288	50.02	73.28
8 mm	144	65.95	87.79
10 mm	96	86.30	110.13
14 mm	48	115.2	136.1
18 mm	15	75.0	92.9
4483			
8 mm	144	63.3	88.4
10 mm	96	77.76	104.6
12 mm	48	66.7	91.1
14 mm	24	53.0	72.8
4500			
3x2 mm	1,440	20.5	32.0
6x2 mm	720	18.4	27.5

Article Size	Packing Unit = Minimum Order Quantity in Pieces	Average Net Weight in Gram per Packing Unit Crystal (001)	Average Gross Weight in Gram per Packing Unit Crystal (001)
4501			
4x2 mm	720	16.8	25.9
5x2 mm	720	18.1	27.2
5x2.5 mm	720	20.9	30.0
7x3 mm	720	60.2	71.1
4502			
3x1 mm	720	2.2	11.4
4527			
8x6 mm	144	53.7	64.6
14x10 mm	72	122.4	144.9
18x13 mm	72	246.9	270.6
4547			
15x5 mm	72	37.4	58.9
21x7 mm	48	65.3	98.7
4568			
14x10 mm	72	74.9	103.1
18x13 mm	24	46.2	64.7
4600			
6x4 mm	360	40.9	51.8
8x6 mm	144	41.2	52.2
10x8 mm	144	84.0	104.0
4610			
14x10 mm	144	171.3	194.9
18x13 mm	48	124.9	145.5
4627			
27x18.5 mm	24	125.3	170.8
4683			
7.8x8.7 mm	144	57.3	80.5
10x11.2 mm	96	75.8	99.4
12x13.5 mm	48	61.0	84.7
14x15.8 mm	24	46.4	67.0
4706			
7 mm	144	23.7	44.4
12 mm	72	61.5	83.9
17 mm	48	96.4	119.8
4722			
4 mm	480	12.0	21.1
6 mm	180	16.4	25.5
4744			
6 mm	720	62.3	72.8
10 mm	288	126.0	158.1
4745			
5 mm	720	35.6	46.4
10 mm	144	48.5	71.3

Article Size	Packing Unit = Minimum Order Quantity in Pieces	Average Net Weight in Gram per Packing Unit Crystal (001)	Average Gross Weight in Gram per Packing Unit Crystal (001)
4809			
13x12 mm	72	47.8	68.5
17x15.5 mm	48	69.3	93.7
4841			
4 mm	288	45.3	66.6
6 mm	144	77.2	95.3
8 mm	72	89.2	107.4
4869			
4 mm	480	36.2	45.3
6 mm	180	47.2	56.4
8 mm	144	90.8	109.0
4884			
5.5x5 mm	360	39.0	49.7
6.6x6 mm	360	67.2	78.0
8.8x8 mm	288	111.4	138.1
11x10 mm	144	107.3	127.4