

Flat Backs Hotfix

Flat Backs Hotfix possess a flat reverse side, and are pre-coated with a heat sensitive glue. They are easily applied to a large range of textiles producing a shimmering, durable and long-lasting design.

The captivating beauty of the Flat Back Rose, Xilion and Xirius Rose is crafted by a unique silver mirror coating on its reverse side, resulting in amplified light reflection and a warmer appearance.

The most coveted and famous item in this product group is article 2078 XIRIUS Rose. Incredibly progressive, and completely unique, multi-layer cutting technology is used to create the inspiring XIRIUS star design, allowing for superior shine, and rich, well-balanced light refraction, redefining the market standard.



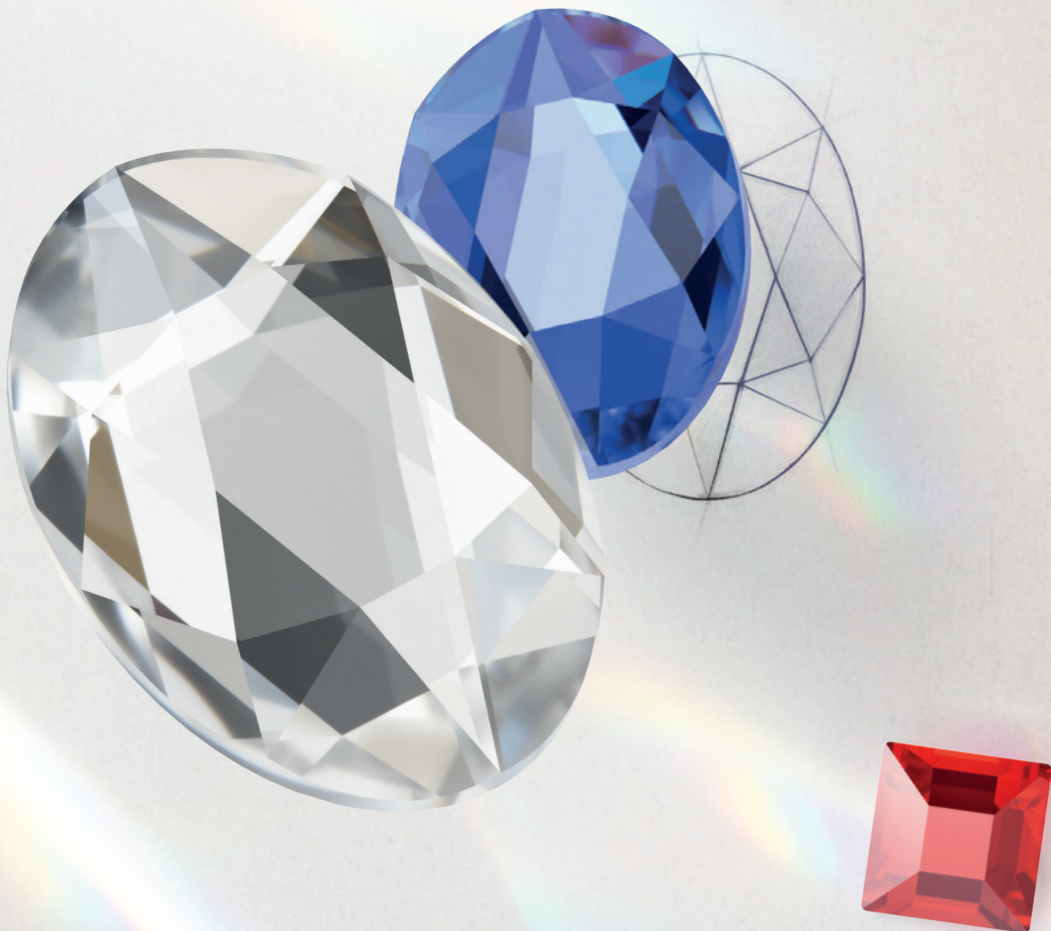

























Swarovski's outstanding quality is underlined by the highest precision in table size and diameter.





























Colors & Effects





OPEN TO SEE COLORS & EFFECTS

Colors

-  Crystal 001
-  Crystal Hotfix Transparent 001 HFT
-  White Opal 234
-  Light Silk 261
-  Silk 391
-  Light Peach 362
-  Vintage Rose 319
-  Blush Rose 257
-  Light Rose 223
-  Rose Peach 262
-  Padparadscha 542
-  Indian Pink 289
-  Rose 209
-  Fuchsia 502
-  Light Siam 227
-  Scarlet 276
-  Indian Siam 327
-  Siam 208
-  Ruby 501
-  Burgundy 515
-  Amethyst 204
-  Iris 219
-  Light Amethyst 212
-  Provence Lavender 283
-  Tanzanite 539
-  Purple Velvet 277
-  Aquamarine 202
-  Light Sapphire 211



-  Sapphire 206
-  Capri Blue 243
-  Majestic Blue 296
-  Cobalt 369
-  Dark Indigo 288
-  Montana 207
-  Denim Blue 266
-  Indicolite 379
-  Light Turquoise 263
-  Blue Zircon 229
-  Erinite 360
-  Chrysolite 238
-  Peridot 214
-  Citrus Green 337
-  Fern Green 291
-  Emerald 205
-  Jonquill 213
-  Light Topaz 226
-  Golden Topaz 1003
-  Light Colorado Topaz 246
-  Topaz 203
-  Light Amber 1002
-  Smoked Amber 1001
-  Greige 284
-  Black Diamond 215
-  Graphite 253
-  Jet 280

Effects







-  Crystal Moonlight 001 MOL
-  Crystal Shimmer 001 SHIM
-  Crystal Transmission Hotfix Transparent 001 TRA HFT
-  Crystal Aurore Boreale 001 AB
-  Crystal Paradise Shine 001 PARSH
-  Crystal Volcano 001 VOL
-  Crystal Blue Shade 001 BLSH
-  Crystal Golden Shadow 001 GSHA
-  Crystal Metallic Sunshine 001 METSH
-  Crystal Rose Gold 001 ROGL
-  Crystal Light Chrome 001 LTCH
-  Crystal Silver Shade 001 SSHA
-  Crystal Silver Night 001 SINI
-  Jet Hematite 280 HEM

Crystal Lacquer^{PRO} Effects

Crystal Lacquer^{PRO} Ignite Effects

-  Crystal Linen Ignite
001 L164I
-  Crystal Flamingo Ignite
001 L162I
-  Crystal Orange Ignite
001 L159I
-  Crystal Maroon Ignite
001 L160I
-  Crystal Purple Ignite
001 L161I
-  Crystal Sky Ignite
001 L163I





Crystal Electric Lacquer^{PRO} Effects

-  Crystal Electric White
001 L139S
-  Crystal Electric Orange
001 L136S
-  Crystal Electric Pink
001 L137S
-  Crystal Electric Violet
001 L148S
-  Crystal Electric Blue
001 L134S
-  Crystal Electric Green
001 L135S
-  Crystal Electric Yellow
001 L138S

Shimmer Effects

-  Silk Shimmer
391 SHIM
-  Light Rose Shimmer
223 SHIM
-  Fuchsia Shimmer
502 SHIM
-  Light Siam Shimmer
227 SHIM
-  Tanzanite Shimmer
539 SHIM
-  Light Sapphire Shimmer
211 SHIM
-  Blue Zircon Shimmer
229 SHIM
-  Peridot Shimmer
214 SHIM
-  Topaz Shimmer
203 SHIM
-  Black Diamond Shimmer
215 SHIM

AB Effects

-  Light Rose Aurore Boreale
223 AB
-  Light Siam Aurore Boreale
227 AB
-  Sapphire Aurore Boreale
206 AB
-  Jonquil Aurore Boreale
213 AB
-  Jet Aurore Boreale
280 AB

Nightfall Effects

-  Siam Nightfall
208 NIFA
-  Capri Blue Nightfall
243 NIFA
-  Emerald Nightfall
205 NIFA
-  Graphite Nightfall
253 NIFA

Cabochons

-  Crystal White Pearl
001 650
-  Crystal Nacre
001 191
-  Crystal Creampearl
001 291
-  Crystal Golden Shadow
001 GSHA
-  Crystal Rosaline Pearl
001 294
-  Crystal Dark Grey Pearl
001 617
-  Jet
280
-  Jet Hematite
280 HEM

Rimmed Flat Backs

-  Jet Light Chrome Z
280 LTCHZ

Numerical Order

| | | | | | |
|-------------|---|----------|---------------------------|-----------|--------------------|
| 001 | Crystal | 204 | Amethyst | 261 | Light Silk |
| 001 191 | Crystal Nacre | 205 NIFA | Emerald Nightfall | 262 | Rose Peach |
| 001 291 | Crystal Creampearl | 205 | Emerald | 263 | Light Turquoise |
| 001 294 | Crystal Rosaline Pearl | 206 AB | Sapphire Aurore Boreale | 266 | Denim Blue |
| 001 617 | Crystal Dark Grey Pearl | 206 | Sapphire | 276 | Scarlet |
| 001 650 | Crystal White Pearl | 207 | Montana | 277 | Purple Velvet |
| 001 AB | Crystal Aurore Boreale | 208 NIFA | Siam Nightfall | 280 AB | Jet Aurore Boreale |
| 001 BLSH | Crystal Blue Shade | 208 | Siam | 280 HEM | Jet Hematite |
| 001 GSHA | Crystal Golden Shadow | 209 | Rose | 280 LTCHZ | Jet Light Chrome Z |
| 001 HFT | Crystal Hotfix Transparent | 211 SHIM | Light Sapphire Shimmer | 280 | Jet |
| 001 LI34S | Crystal Electric Blue | 211 | Light Sapphire | 283 | Provence Lavender |
| 001 LI35S | Crystal Electric Green | 212 | Light Amethyst | 284 | Greige |
| 001 LI36S | Crystal Electric Orange | 213 AB | Jonquil Aurore Boreale | 288 | Dark Indigo |
| 001 LI37S | Crystal Electric Pink | 213 | Jonquil | 289 | Indian Pink |
| 001 LI38S | Crystal Electric Yellow | 214 SHIM | Peridot Shimmer | 291 | Fern Green |
| 001 LI39S | Crystal Electric White | 214 | Peridot | 296 | Majestic Blue |
| 001 LI48S | Crystal Electric Violet | 215 SHIM | Black Diamond Shimmer | 319 | Vintage Rose |
| 001 LI59I | Crystal Orange Ignite | 215 | Black Diamond | 327 | Indian Siam |
| 001 LI60I | Crystal Maroon Ignite | 219 | Iris | 337 | Citrus Green |
| 001 LI61I | Crystal Purple Ignite | 223 AB | Light Rose Aurore Boreale | 360 | Erinite |
| 001 LI62I | Crystal Flamingo Ignite | 223 SHIM | Light Rose Shimmer | 362 | Light Peach |
| 001 LI63I | Crystal Sky Ignite | 223 | Light Rose | 369 | Cobalt |
| 001 LI64I | Crystal Linen Ignite | 226 | Light Topaz | 379 | Indicolite |
| 001 LTCH | Crystal Light Chrome | 227 AB | Light Siam Aurore Boreale | 391 SHIM | Silk Shimmer |
| 001 METSH | Crystal Metallic Sunshine | 227 SHIM | Light Siam Shimmer | 391 | Silk |
| 001 MOL | Crystal Moonlight | 227 | Light Siam | 501 | Ruby |
| 001 PARSH | Crystal Paradise Shine | 229 SHIM | Blue Zircon Shimmer | 502 SHIM | Fuchsia Shimmer |
| 001 ROGL | Crystal Rose Gold | 229 | Blue Zircon | 502 | Fuchsia |
| 001 SHIM | Crystal Shimmer | 234 | White Opal | 515 | Burgundy |
| 001 SINI | Crystal Silver Night | 238 | Chrysolite | 539 SHIM | Tanzanite Shimmer |
| 001 SSHA | Crystal Silver Shade | 243 NIFA | Capri Blue Nightfall | 539 | Tanzanite |
| 001 TRA HFT | Crystal Transmission Hotfix Transparent | 243 | Capri Blue | 542 | Padparadscha |
| 001 VOL | Crystal Volcano | 246 | Light Colorado Topaz | 1001 | Smoked Amber |
| 202 | Aquamarine | 253 NIFA | Graphite Nightfall | 1002 | Light Amber |
| 203 SHIM | Topaz Shimmer | 253 | Graphite | 1003 | Golden Topaz |
| 203 | Topaz | 257 | Blush Rose | | |

Alphabetical Order

| | | |
|---------------------------------------|---|------------------------------------|
| Amethyst (204) | Crystal Purple Ignite (001 L1611) | Light Rose (223) |
| Aquamarine (202) | Crystal Rosaline Pearl (001 294) | Light Rose Aurore Boreale (223 AB) |
| Black Diamond (215) | Crystal Rose Gold (001 ROGL) | Light Rose Shimmer (223 SHIM) |
| Black Diamond Shimmer (215 SHIM) | Crystal Shimmer (001 SHIM) | Light Sapphire (211) |
| Blue Zircon (229) | Crystal Silver Night (001 SINI) | Light Sapphire Shimmer (211 SHIM) |
| Blue Zircon Shimmer (229 SHIM) | Crystal Silver Shade (001 SSHA) | Light Siam (227) |
| Blush Rose (257) | Crystal Sky Ignite (001 L1631) | Light Siam Aurore Boreale (227 AB) |
| Burgundy (515) | Crystal Transmission Hotfix Transparent (001 TRA HFT) | Light Siam Shimmer (227 SHIM) |
| Capri Blue (243) | Crystal Volcano (001 VOL) | Light Silk (261) |
| Capri Blue Nightfall (243 NIFA) | Crystal White Pearl (001 650) | Light Topaz (226) |
| Chrysolite (238) | Dark Indigo (288) | Light Turquoise (263) |
| Citrus Green (337) | Denim Blue (266) | Majestic Blue (296) |
| Cobalt (369) | Emerald (205) | Montana (207) |
| Crystal (001) | Emerald Nightfall (205 NIFA) | Padparadscha (542) |
| Crystal Aurore Boreale (001 AB) | Erinite (360) | Peridot (214) |
| Crystal Blue Shade (001 BLSH) | Fern Green (291) | Peridot Shimmer (214 SHIM) |
| Crystal Creampearl (001 291) | Fuchsia (502) | Provence Lavender (283) |
| Crystal Dark Grey Pearl (001 617) | Fuchsia Shimmer (502 SHIM) | Purple Velvet (277) |
| Crystal Electric Blue (001 L134S) | Golden Topaz (1003) | Rose (209) |
| Crystal Electric Green (001 L135S) | Graphite (253) | Rose Peach (262) |
| Crystal Electric Orange (001 L136S) | Graphite Nightfall (253 NIFA) | Ruby (501) |
| Crystal Electric Pink (001 L137S) | Greige (284) | Sapphire (206) |
| Crystal Electric Violet (001 L148S) | Indian Pink (289) | Sapphire Aurore Boreale (206 AB) |
| Crystal Electric White (001 L139S) | Indian Siam (327) | Scarlet (276) |
| Crystal Electric Yellow (001 L138S) | Indicolite (379) | Siam (208) |
| Crystal Flamingo Ignite (001 L1621) | Iris (219) | Siam Nightfall (208 NIFA) |
| Crystal Golden Shadow (001 GSHA) | Jet (280) | Silk (391) |
| Crystal Hotfix Transparent (001 HFT) | Jet Aurore Boreale (280 AB) | Silk Shimmer (391 SHIM) |
| Crystal Light Chrome (001 LTCH) | Jet Hematite (280 HEM) | Smoked Amber (1001) |
| Crystal Linen Ignite (001 L1641) | Jet Light Chrome Z (280 LTCHZ) | Tanzanite (539) |
| Crystal Maroon Ignite (001 L1601) | Jonquil (213) | Tanzanite Shimmer (539 SHIM) |
| Crystal Metallic Sunshine (001 METSH) | Jonquil Aurore Boreale (213 AB) | Topaz (203) |
| Crystal Moonlight (001 MOL) | Light Amber (1002) | Topaz Shimmer (203 SHIM) |
| Crystal Nacre (001 191) | Light Amethyst (212) | Vintage Rose (319) |
| Crystal Orange Ignite (001 L1591) | Light Colorado Topaz (246) | White Opal (234) |
| Crystal Paradise Shine (001 PARSH) | Light Peach (362) | |

03

For details on available colors and effects for each article within the product groups, please see the product matrix of the respective item in the Collection 2023.













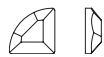



















The plating resistance of effects is tested according to Swarovski's plating guidelines (SWAROVSKI.COM/S-PROFESSIONALS). Customers are advised to carry out their own tests if their plating parameters diverge from Swarovski plating guidelines.

Colors and effects can appear different when illuminated with different light sources. Swarovski uses standard light source D65 for color decision and comparison. Slight changes in shades are unavoidable. Colors may vary according to cut and foiling.

The composition of Advanced Crystal is compliant with regulatory industry norms and laws regarding the restriction or prohibition of certain substances in the most relevant segments of our customers. Please note that the compliance of the colors Light Siam and Siam varies according to certain industry regulations. Those regulations are indicated with * in the compliance overview. Indian Siam, Ruby and Scarlet (option to Lt. Siam) conform to all CLEAR-lists. For further information please visit swarovski.com/s-professionals

© 2023 D. Swarovski Distribution GmbH

Summary

| | | | | | | | | |
|-------|---|---|-----|---|--|-----|---|--|
| 1 2 3 |  | 1098 A HF PP 24 (SS 12), PP 31 (SS 16) SS 20 | 1 2 |  | 2303 M HF 8x5, 14x9 mm | 1 2 |  | 2715 M HF 3, 4 mm |
| |  | 2000 A HF SS 3 | |  | 2304 M HF 10x2.8, 14x3.9 mm | |  | 2738 M HF 10x5, 12x6 mm |
| |  | 2038 A HF SS 5, 6, 8, 10 | |  | 2400 M HF 2.2, 3, 4, 6 mm | |  | 2739 M HF 5.8x5.3, 7x6.5 mm |
| |  | 2038/1 A HF SS 10 | |  | 2471 M HF 5, 7, 10 mm | |  | 2740 M HF 8.3x8.3, 10x10 mm |
| |  | 2078 A HF SS 12, 16, 20, 30, 34, 40, 48 | |  | 2472 M HF 5, 7, 10 mm | |  | 2754 M HF 4, 6 mm |
| |  | 2078/1 A HF SS 16, 20 | |  | 2510 M HF 3.7x1.9, 5x2.5 mm | |  | 2770 M HF 6x3.5 mm |
| |  | 2080/4 HF SS 6, 10, 16, 20, 34 | |  | 2555 M HF 8x2.6, 12x4 mm | |  | 2771 M HF 6.4x4.2, 8.6x5.6, 12.9x8.3 mm |
| |  | 2200 HF 4x2, 8x4 mm | |  | 2602 M HF 3.7x2.5, 8x5.5, 14x10 mm | |  | 2772 M HF 6.5x2.1, 8.6x2.8, 12.9x4.2 mm |
| |  | 2201 M HF 4x1.8, 8x3.5, 14x6 mm | |  | 2603 M HF 4x3, 8x6, 14x10 mm | |  | 2773 M HF 5x3, 6.6x3.9, 9.9x5.9 mm |
| |  | 2205 M HF 7.5, 10, 14 mm | |  | 2709 M HF 10x6 mm | |  | 2774 M HF 6.3x4.2, 8.3x5.6, 12.5x8.4 mm |
| |  | 2300 M HF 8x4.8 mm | |  | 2711 M HF 3.3, 6 mm | |  | 2775 M HF 5x4.2, 6.7x5.6, 10x8.4 mm |

1 Top view 2 Side view 3 Back view

1 2



2776 M HF
8.2x4.2, 11x5.6,
16.5x8.4 mm



2777 M HF
5x4.2, 6.7x5.6,
10x8.4 mm



2788 M HF
8 mm



2808 M HF
3.6, 6, 10 mm



2813 M HF
8x5.5 mm



2816 M HF
5 mm

1098 XIRIUS Light

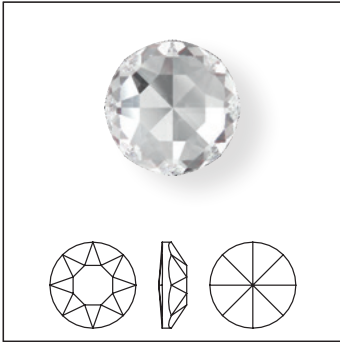

| Size | PP 24 SS 12 | PP 31 SS 16 | SS 20 |
|------|---------------|---------------|-------|
|------|---------------|---------------|-------|

Crystal

Crystal A HF (001)

Crystal Effects

Transparent Effects

Crystal Aurore Boreale A HF (001 AB)

Crystal Golden Shadow A HF (001 GSHA)

Crystal Silver Night A HF (001 SINI)

Crystal Silver Shade A HF (001 SSHA)

2000 Rose

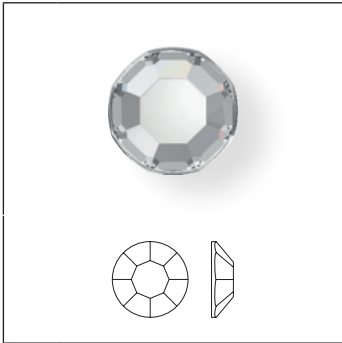

Size SS 3

2038 XILION Rose

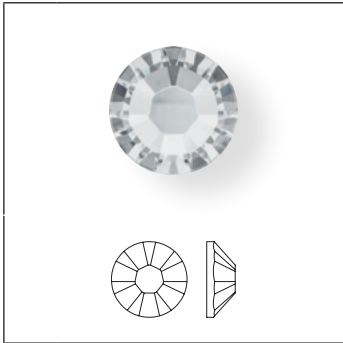

Size SS 5, 6, 8, 10

2078 XIRIUS Rose

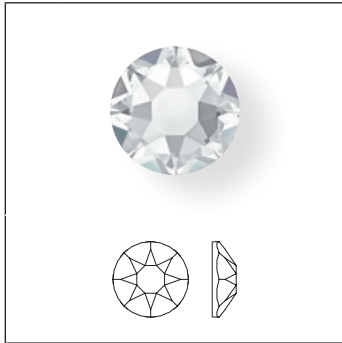





























Size SS 12, 16, 20, 30, 34, 40, 48

| | 2000 Rose | 2038 XILION Rose | 2078 XIRIUS Rose |
|--------------------------------------|-----------|------------------|------------------|
| Crystal | | | |
| Crystal Hotfix Transparent (001 HFT) | ■ | ■ | ■ |
| Crystal A HF (001) | ■ | ■ | ■ |
| Colors | | | |
| Plain Colors | | | |
| Amethyst A HF (204) | ■ | ■ | ■ |
| Aquamarine A HF (202) | ■ | ■ | ■ |
| Black Diamond A HF (215) | ■ | ■ | ■ |
| Blue Zircon A HF (229) | ■ | ■ | ■ |
| Blush Rose A HF (257) | ■ | ■ | ■ |
| Burgundy A HF (515) | ■ | ■ | ■ |
| Capri Blue A HF (243) | ■ | ■ | ■ |
| Chrysolite A HF (238) | ■ | ■ | ■ |
| Citrus Green A HF (337) | ■ | ■ | ■ |
| Cobalt A HF (369) | ■ | ■ | ■ |
| Dark Indigo A HF (288) | ■ | ■ | ■ |
| Denim Blue A HF (266) | ■ | ■ | ■ |
| Emerald A HF (205) | ■ | ■ | ■ |

| | 2000 | | | 2038 | | | | 2078 | | | | | | | | |
|---------------------------------|------|-----------|------|------------------|------|------|------|-------|------------------|-------|-------|-------|-------|-------|-------|-------|
| | Size | 2000 Rose | SS 3 | 2038 XILION Rose | SS 5 | SS 6 | SS 8 | SS 10 | 2078 XIRIUS Rose | SS 12 | SS 16 | SS 20 | SS 30 | SS 34 | SS 40 | SS 48 |
| Erinite A HF (360) | | | | | | | | | | | | | | | | |
| Fern Green A HF (291) | | | | | | | | | | | | | | | | |
| Fuchsia A HF (502) | | | | | | | | | | | | | | | | |
| Golden Topaz A HF (1003)* | | | | | | | | | | | | | | | | |
| Graphite A HF (253) | | | | | | | | | | | | | | | | |
| Greige A HF (284) | | | | | | | | | | | | | | | | |
| Indian Pink A HF (289) | | | | | | | | | | | | | | | | |
| Indian Siam A HF (327) | | | | | | | | | | | | | | | | |
| Indicolite A HF (379) | | | | | | | | | | | | | | | | |
| Iris A HF (219) | | | | | | | | | | | | | | | | |
| Jet HFT (280) | | | | | | | | | | | | | | | | |
| Jet A HF (280) | | | | | | | | | | | | | | | | |
| Jonquil A HF (213) | | | | | | | | | | | | | | | | |
| Light Amber A HF (1002)* | | | | | | | | | | | | | | | | |
| Light Amethyst A HF (212) | | | | | | | | | | | | | | | | |
| Light Colorado Topaz A HF (246) | | | | | | | | | | | | | | | | |
| Light Peach A HF (362) | | | | | | | | | | | | | | | | |
| Light Rose A HF (223) | | | | | | | | | | | | | | | | |
| Light Sapphire A HF (211) | | | | | | | | | | | | | | | | |
| Light Siam A HF (227) | | | | | | | | | | | | | | | | |
| Light Silk A HF (261) | | | | | | | | | | | | | | | | |
| Light Topaz A HF (226) | | | | | | | | | | | | | | | | |
| Light Turquoise A HF (263) | | | | | | | | | | | | | | | | |
| Majestic Blue A HF (296) | | | | | | | | | | | | | | | | |
| Montana A HF (207) | | | | | | | | | | | | | | | | |
| Padparadscha A HF (542) | | | | | | | | | | | | | | | | |
| Peridot A HF (214) | | | | | | | | | | | | | | | | |
| Provence Lavender A HF (283) | | | | | | | | | | | | | | | | |
| Purple Velvet A HF (277) | | | | | | | | | | | | | | | | |
| Rose A HF (209) | | | | | | | | | | | | | | | | |
| Rose Peach A HF (262) | | | | | | | | | | | | | | | | |
| Ruby A HF (501) | | | | | | | | | | | | | | | | |

* All colors with a 4-digit color code (i.e. Golden Topaz) are fully customizable with shorter lead times and lower MOQs compared to our 3-digit colors. Please get in touch with the Customer Service for a time and quantity estimation of your desired variant.

| 2000 2038 2078 | | Size | 2000 Rose | SS 3 | 2038 XILION Rose | SS 5 | SS 6 | SS 8 | SS 10 | 2078 XIRIUS Rose | SS 12 | SS 16 | SS 20 | SS 30 | SS 34 | SS 40 | SS 48 |
|---|--|------|-----------|------|------------------|------|------|------|-------|------------------|-------|-------|-------|-------|-------|-------|-------|
|  | Sapphire A HF (206) | | ■ | | ■ | ■ | ■ | ■ | ■ | ■ | ■ | ■ | ■ | | | | |
|  | Scarlet A HF (276) | | | | ■ | ■ | ■ | ■ | ■ | ■ | ■ | ■ | ■ | | | | |
|  | Siam A HF (208) | | | | ■ | ■ | ■ | ■ | ■ | ■ | ■ | ■ | ■ | | | | |
|  | Silk A HF (391) | | ■ | | ■ | ■ | ■ | ■ | ■ | ■ | ■ | ■ | ■ | | | | |
|  | Smoked Amber A HF (1001)* | | ■ | | ■ | ■ | ■ | ■ | ■ | ■ | ■ | ■ | ■ | | | | |
|  | Tanzanite A HF (539) | | ■ | | ■ | ■ | ■ | ■ | ■ | ■ | ■ | ■ | ■ | | | | |
|  | Topaz A HF (203) | | | | ■ | ■ | ■ | ■ | ■ | ■ | ■ | ■ | ■ | | | | |
|  | Vintage Rose A HF (319) | | ■ | | ■ | ■ | ■ | ■ | ■ | ■ | ■ | ■ | ■ | | | | |
| Opal Colors | | | | | | | | | | | | | | | | | |
|  | White Opal A HF (234) | | | | | ■ | ■ | ■ | ■ | ■ | ■ | ■ | ■ | | | | |
| Crystal Effects | | | | | | | | | | | | | | | | | |
| Transparent Effects | | | | | | | | | | | | | | | | | |
|  | Crystal Aureore Boreale A HF (001 AB) | | ■ | | ■ | ■ | ■ | ■ | ■ | ■ | ■ | ■ | ■ | ■ | ■ | ■ | ■ |
|  | Crystal Blue Shade A HF (001 BLSH) | | | | | ■ | ■ | ■ | ■ | ■ | ■ | ■ | ■ | | | | |
|  | Crystal Golden Shadow A HF (001 GSHA) | | ■ | | ■ | ■ | ■ | ■ | ■ | ■ | ■ | ■ | ■ | | | | |
|  | Crystal Moonlight A HF (001 MOL) | | ■ | | ■ | ■ | ■ | ■ | ■ | ■ | ■ | ■ | ■ | | | | |
|  | Crystal Paradise Shine A HF (001 PARSH) | | ■ | | ■ | ■ | ■ | ■ | ■ | ■ | ■ | ■ | ■ | | | | |
|  | Crystal Shimmer A HF (001 SHIM) | | ■ | | ■ | ■ | ■ | ■ | ■ | ■ | ■ | ■ | ■ | | | | |
|  | Crystal Silver Night A HF (001 SINI) | | ■ | | ■ | ■ | ■ | ■ | ■ | ■ | ■ | ■ | ■ | | | | |
|  | Crystal Silver Shade A HF (001 SSHA) | | ■ | | ■ | ■ | ■ | ■ | ■ | ■ | ■ | ■ | ■ | | | | |
|  | Crystal Transmission HFT (001 TRA HFT) | | ■ | | ■ | ■ | ■ | ■ | ■ | ■ | ■ | ■ | ■ | | | | |
|  | Crystal Volcano A HF (001 VOL) | | | | ■ | ■ | ■ | ■ | ■ | ■ | ■ | ■ | ■ | | | | |
| Metallic Effects | | | | | | | | | | | | | | | | | |
|  | Crystal Light Chrome A HF (001 LTCH) | | ■ | | ■ | ■ | ■ | ■ | ■ | ■ | ■ | ■ | ■ | | | | |
|  | Crystal Metallic Sunshine A HF (001 METSH) | | ■ | | ■ | ■ | ■ | ■ | ■ | ■ | ■ | ■ | ■ | | | | |
|  | Crystal Rose Gold A HF (001 ROGL) | | ■ | | ■ | ■ | ■ | ■ | ■ | ■ | ■ | ■ | ■ | | | | |
| Crystal Lacquer^{PRO} Effects | | | | | | | | | | | | | | | | | |
| Crystal Lacquer^{PRO} Ignite Effects | | | | | | | | | | | | | | | | | |
|  | Crystal Flamingo Ignite HFT (001 L162I) | | | | | | | | ■ | | ■ | ■ | ■ | | | | |
|  | Crystal Linen Ignite HFT (001 L164I) | | | | | | | | ■ | | ■ | ■ | ■ | | | | |
|  | Crystal Maroon Ignite HFT (001 L160I) | | | | | | | | ■ | | ■ | ■ | ■ | | | | |
|  | Crystal Orange Ignite HFT (001 L159I) | | | | | | | | ■ | | ■ | ■ | ■ | | | | |
|  | Crystal Purple Ignite HFT (001 L161I) | | | | | | | | ■ | | ■ | ■ | ■ | | | | |
|  | Crystal Sky Ignite HFT (001 L163I) | | | | | | | | ■ | | ■ | ■ | ■ | | | | |

* All colors with a 4-digit color code (i.e. Golden Topaz) are fully customizable with shorter lead times and lower MOQs compared to our 3-digit colors. Please get in touch with the Customer Service for a time and quantity estimation of your desired variant.

| | Size | 2000 Rose | SS 3 | 2038 XILION Rose | SS 5 | SS 6 | SS 8 | SS 10 | 2078 XIRIUS Rose | SS 12 | SS 16 | SS 20 | SS 30 | SS 34 | SS 40 | SS 48 |
|---|------|-----------|------|------------------|------|------|------|-------|------------------|-------|-------|-------|-------|-------|-------|-------|
| 2000 2038 2078 | | | | | | | | | | | | | | | | |
| Crystal Electric Lacquer^{PRO} Effects | | | | | | | | | | | | | | | | |
| Crystal Electric Blue HFT (001 L134S) | | | | | | | | ■ | | ■ | ■ | ■ | | | | |
| Crystal Electric Green HFT (001 L135S) | | | | | | | | ■ | | ■ | ■ | ■ | | | | |
| Crystal Electric Orange HFT (001 L136S) | | | | | | | | ■ | | ■ | ■ | ■ | | | | |
| Crystal Electric Pink HFT (001 L137S) | | | | | | | | ■ | | ■ | ■ | ■ | | | | |
| Crystal Electric Violet HFT (001 L148S) | | | | | | | | ■ | | ■ | ■ | ■ | | | | |
| Crystal Electric White HFT (001 L139S) | | | | | | | | ■ | | ■ | ■ | ■ | | | | |
| Crystal Electric Yellow HFT (001 L138S) | | | | | | | | ■ | | ■ | ■ | ■ | | | | |
| Color Effects | | | | | | | | | | | | | | | | |
| Transparent Effects | | | | | | | | | | | | | | | | |
| Black Diamond Shimmer A HF (215 SHIM) | | ■ | | ■ | | ■ | | ■ | | ■ | ■ | ■ | | | | |
| Blue Zircon Shimmer A HF (229 SHIM) | | | | ■ | | ■ | | ■ | | ■ | ■ | ■ | | | | |
| Capri Blue Nightfall A HF (243 NIFA) | | | | ■ | | ■ | | ■ | ■ | ■ | ■ | ■ | | | | |
| Emerald Nightfall A HF (205 NIFA) | | | | ■ | | ■ | | ■ | ■ | ■ | ■ | ■ | | | | |
| Fuchsia Shimmer A HF (502 SHIM) | | | | ■ | | ■ | | ■ | | ■ | ■ | ■ | | | | |
| Graphite Nightfall A HF (253 NIFA) | | | | ■ | | ■ | | ■ | ■ | ■ | ■ | ■ | | | | |
| Jet AB A HF (253 NIFA) | | ■ | | ■ | | ■ | | ■ | | ■ | ■ | ■ | | | | |
| Jonquil AB A HF (213 AB) | | ■ | | ■ | | ■ | | ■ | | ■ | ■ | ■ | | | | |
| Light Rose AB A HF (223 AB) | | | | ■ | | ■ | | ■ | ■ | ■ | ■ | ■ | | | | |
| Light Rose Shimmer A HF (223 SHIM) | | ■ | | ■ | | ■ | | ■ | | ■ | ■ | ■ | | | | |
| Light Sapphire Shimmer A HF (211 SHIM) | | | | ■ | | ■ | | ■ | | ■ | ■ | ■ | | | | |
| Light Siam AB A HF (227 AB) | | ■ | | ■ | | ■ | | ■ | ■ | ■ | ■ | ■ | | | | |
| Light Siam Shimmer A HF (227 SHIM) | | ■ | | ■ | | ■ | | ■ | | ■ | ■ | ■ | | | | |
| Peridot Shimmer A HF (214 SHIM) | | | | ■ | | ■ | | ■ | | ■ | ■ | ■ | | | | |
| Sapphire AB A HF (206 AB) | | ■ | | ■ | | ■ | | ■ | ■ | ■ | ■ | ■ | | | | |
| Siam Nightfall A HF (208 NIFA) | | | | ■ | | ■ | | ■ | ■ | ■ | ■ | ■ | | | | |
| Silk Shimmer A HF (391 SHIM) | | ■ | | ■ | | ■ | | ■ | | ■ | ■ | ■ | | | | |
| Tanzanite Shimmer A HF (539 SHIM) | | ■ | | ■ | | ■ | | ■ | | ■ | ■ | ■ | | | | |
| Topaz Shimmer A HF (203 SHIM) | | | | ■ | | ■ | | ■ | | ■ | ■ | ■ | | | | |
| Metallic Effects | | | | | | | | | | | | | | | | |
| Jet Hematite A HF (280 HEM) | | ■ | | ■ | ■ | ■ | | ■ | | ■ | ■ | ■ | | | | |

* All colors with a 4-digit color code (i.e. Golden Topaz) are fully customizable with shorter lead times and lower MOQs compared to our 3-digit colors. Please get in touch with the Customer Service for a time and quantity estimation of your desired variant.

2038/I Rimmed Flat Back

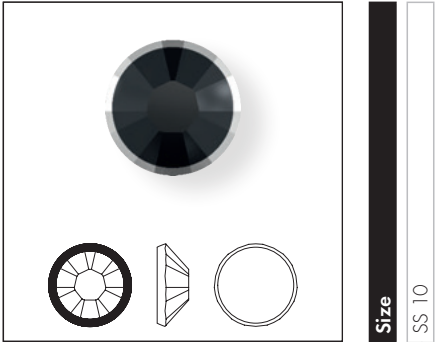

Size
SS 10

Color Effects

Metallic Effects

Jet & Light Chrome Z A HF (280 ITCHZ)

2078/I Rimmed Flat Back

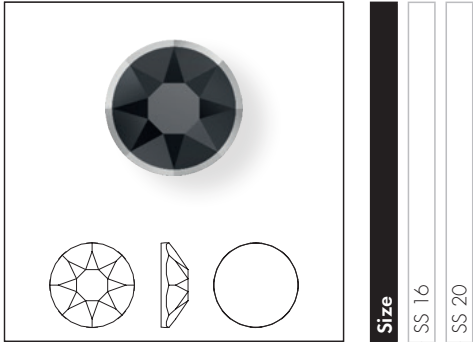

Size
SS 16
SS 20

Color Effects

Metallic Effects

Jet & Light Chrome Z A HF (280 ITCHZ)

CABOCHON

2080/4 Cabochon



| Size |
|-------|
| SS 6 |
| SS 10 |
| SS 16 |
| SS 20 |
| SS 34 |

Colors

Plain Colors

● Jet M HF (280)

Crystal Effects

Transparent Effects

● Crystal Golden Shadow HF (001 GSHA)

Color Effects

Metallic Effects

● Jet Hematite M HF (280 HEM)

Pearl Colors

● Crystal Creampearl HF (001 CMPRL)

● Crystal Dark Grey Pearl HF (001 DGREY)

● Crystal Nacre HF (001 NACRE)

● Crystal Rosaline Pearl HF (001 ROPRL)

● Crystal White Pearl HF (001 WHITE)

| | | | | | |
|--|---|---|---|---|---|
| Jet M HF (280) | ■ | ■ | ■ | ■ | ■ |
| Crystal Golden Shadow HF (001 GSHA) | ■ | ■ | ■ | ■ | ■ |
| Jet Hematite M HF (280 HEM) | ■ | ■ | ■ | ■ | ■ |
| Crystal Creampearl HF (001 CMPRL) | ■ | ■ | ■ | ■ | ■ |
| Crystal Dark Grey Pearl HF (001 DGREY) | ■ | ■ | ■ | ■ | ■ |
| Crystal Nacre HF (001 NACRE) | ■ | ■ | ■ | ■ | ■ |
| Crystal Rosaline Pearl HF (001 ROPRL) | ■ | ■ | ■ | ■ | ■ |
| Crystal White Pearl HF (001 WHITE) | ■ | ■ | ■ | ■ | ■ |

2200 Navette Flat Back



| Crystal | |
|---------------------------------------|--------------------------|
| Crystal M HF (001) | <input type="checkbox"/> |
| Colors | |
| Plain Colors | |
| Aquamarine M HF (202) | <input type="checkbox"/> |
| Black Diamond M HF (215) | <input type="checkbox"/> |
| Emerald M HF (205) | <input type="checkbox"/> |
| Jet M HF (280) | <input type="checkbox"/> |
| Light Colorado Topaz M HF (246) | <input type="checkbox"/> |
| Light Rose M HF (223) | <input type="checkbox"/> |
| Scarlet M HF (276) | <input type="checkbox"/> |
| Crystal Effects | |
| Transparent Effects | |
| Crystal Aurore Boreale M HF (001 AB) | <input type="checkbox"/> |
| Crystal Golden Shadow M HF (001 GSHA) | <input type="checkbox"/> |
| Crystal Silver Shade M HF (001 SSHA) | <input type="checkbox"/> |

2201 Marquise Flat Back

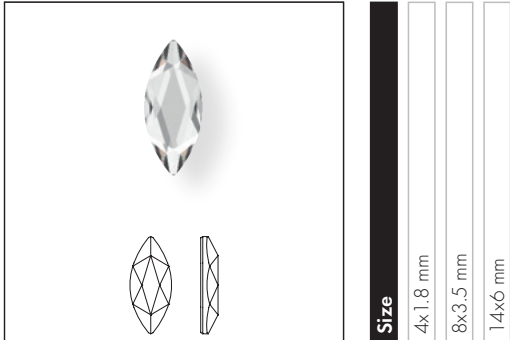

| Crystal | |
|---------------------------------------|--------------------------|
| Crystal M HF (001) | <input type="checkbox"/> |
| Crystal Effects | |
| Transparent Effects | |
| Crystal Aurore Boreale M HF (001 AB) | <input type="checkbox"/> |
| Crystal Golden Shadow M HF (001 GSHA) | <input type="checkbox"/> |

2205 Flame Flat Back

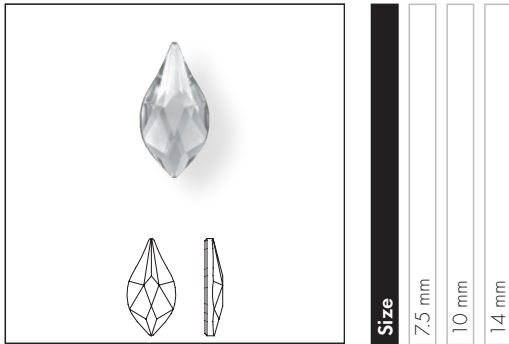

Size
7,5 mm
10 mm
14 mm

Crystal

Crystal M HF (001)

Crystal Effects

Transparent Effects

Crystal Aurore Boreale M HF (001 AB)

Crystal Golden Shadow M HF (001 GSHA)

2300 Drop Flat Back

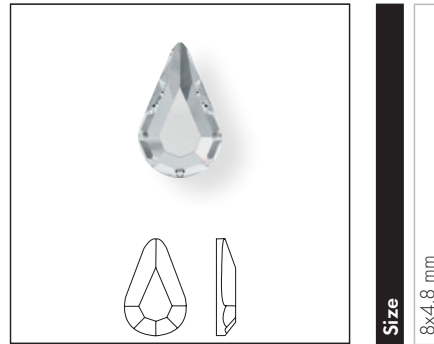

Size
8x4,8 mm

Crystal

Crystal M HF (001)

Colors

Plain Colors

Aquamarine M HF (202)

Black Diamond M HF (215)

Emerald M HF (205)

Jet M HF (280)

Light Colorado Topaz M HF (246)

Light Rose M HF (223)

Scarlet M HF (276)

Crystal Effects

Transparent Effects

Crystal Aurore Boreale M HF (001 AB)

Crystal Golden Shadow M HF (001 GSHA)

2303 Pear Flat Back

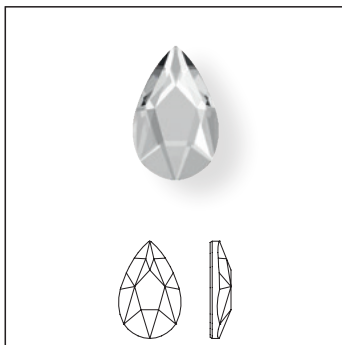

Size
8x5 mm
14x9 mm

Crystal

Crystal M HF (001)

Crystal Effects

Transparent Effects

Crystal Aurore Boreale M HF (001 AB)

Crystal Golden Shadow M HF (001 GSHA)

2304 Raindrop Flat Back

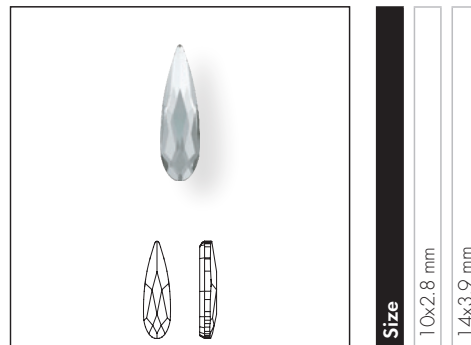

Size
10x2,8 mm
14x3,9 mm

Crystal

Crystal M HF (001)

Crystal Effects

Transparent Effects

Crystal Aurore Boreale M HF (001 AB)

Crystal Golden Shadow M HF (001 GSHA)

2400 Square Flat Back



Size
2.2 mm
3 mm
4 mm
6 mm

| Crystal | |
|---------------------------------------|---------|
| Crystal M HF (001) | ■ ■ ■ ■ |
| Colors | |
| Plain Colors | |
| Amethyst M HF (204) | ■ ■ |
| Aquamarine M HF (202) | ■ ■ |
| Black Diamond M HF (215) | ■ ■ |
| Emerald M HF (205) | ■ ■ |
| Jet M HF (280) | ■ ■ ■ ■ |
| Light Colorado Topaz M HF (246) | ■ ■ |
| Light Rose M HF (223) | ■ ■ |
| Scarlet M HF (276) | ■ ■ |
| Crystal Effects | |
| Transparent Effects | |
| Crystal Aurore Boreale M HF (001 AB) | ■ ■ ■ ■ |
| Crystal Golden Shadow M HF (001 GSHA) | ■ ■ ■ ■ |
| Crystal Silver Night M HF (001 SINI) | ■ ■ |
| Color Effects | |
| Metallic Effects | |
| Jet Hematite M HF (280 HEM) | ■ ■ |

2471 Cushion Flat Back



Size
5 mm
7 mm
10 mm

| Crystal | |
|---------------------------------------|---------|
| Crystal M HF (001) | ■ ■ ■ ■ |
| Colors | |
| Plain Colors | |
| Aquamarine M HF (202) | ■ ■ ■ ■ |
| Emerald M HF (205) | ■ ■ ■ ■ |
| Graphite M HF (253) | ■ ■ ■ ■ |
| Jet M HF (280) | ■ ■ ■ ■ |
| Sapphire M HF (206) | ■ ■ ■ ■ |
| Scarlet M HF (276) | ■ ■ ■ ■ |
| Vintage Rose M HF (319) | ■ ■ ■ ■ |
| Crystal Effects | |
| Transparent Effects | |
| Crystal Aurore Boreale M HF (001 AB) | ■ ■ ■ ■ |
| Crystal Golden Shadow M HF (001 GSHA) | ■ ■ ■ ■ |

2472 Trilliant Flat Back



| Crystal | |
|---------------------------------------|-------|
| Crystal M HF (001) | ■ ■ ■ |
| Colors | |
| Plain Colors | |
| Aquamarine M HF (202) | ■ ■ ■ |
| Emerald M HF (205) | ■ ■ ■ |
| Graphite M HF (253) | ■ ■ ■ |
| Jet M HF (280) | ■ ■ ■ |
| Sapphire M HF (206) | ■ ■ ■ |
| Scarlet M HF (276) | ■ ■ ■ |
| Vintage Rose M HF (319) | ■ ■ ■ |
| Crystal Effects | |
| Transparent Effects | |
| Crystal Aurore Boreale M HF (001 AB) | ■ ■ ■ |
| Crystal Golden Shadow M HF (001 GSHA) | ■ ■ ■ |

2510 Baguette Flat Back

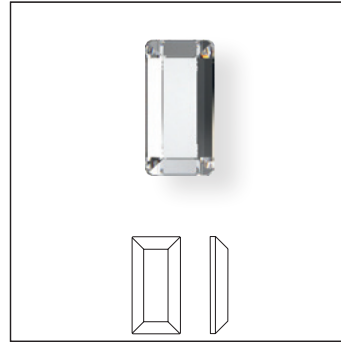

| Crystal | |
|---------------------------------------|-----|
| Crystal M HF (001) | ■ ■ |
| Colors | |
| Plain Colors | |
| Aquamarine M HF (202) | ■ ■ |
| Black Diamond M HF (215) | ■ ■ |
| Emerald M HF (205) | ■ ■ |
| Jet M HF (280) | ■ ■ |
| Light Colorado Topaz M HF (246) | ■ ■ |
| Crystal Effects | |
| Transparent Effects | |
| Crystal Aurore Boreale M HF (001 AB) | ■ ■ |
| Crystal Golden Shadow M HF (001 GSHA) | ■ ■ |

2555 Cosmic Baguette Flat Back

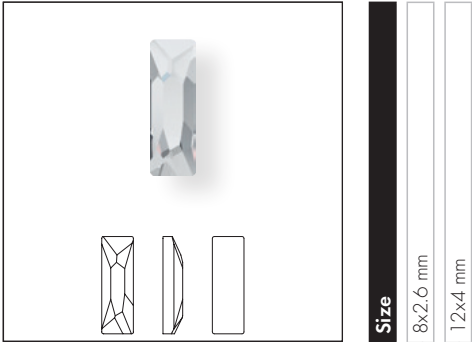

Size
8x2.6 mm
12x4 mm

Crystal

Crystal M HF (001)

Crystal Effects

Transparent Effects

Crystal Aurore Boreale M HF (001 AB)

Crystal Golden Shadow M HF (001 GSHA)

2602 Emerald Cut Flat Back

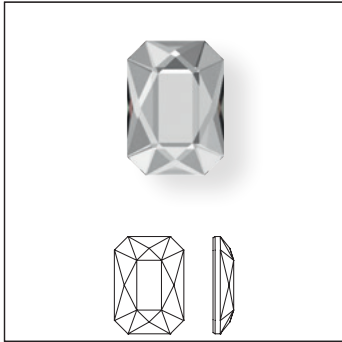

Size
3.7x2.5 mm
8x5.5 mm
14x10 mm

Crystal

Crystal M HF (001)

Colors

Plain Colors

Aquamarine M HF (202)

Emerald M HF (205)

Graphite M HF (253)

Jet M HF (280)

Sapphire M HF (206)

Scarlet M HF (276)

Vintage Rose M HF (319)

Crystal Effects

Transparent Effects

Crystal Aurore Boreale M HF (001 AB)

Crystal Golden Shadow M HF (001 GSHA)

2603 Oval Flat Back

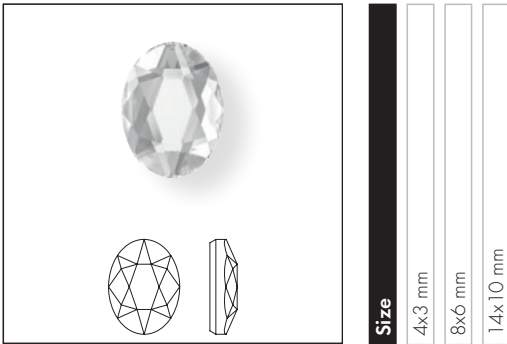

| Crystal | 4x3 mm | 8x6 mm | 14x10 mm |
|---------------------------------------|--------|--------|----------|
| Crystal M HF (001) | ■ | ■ | ■ |
| Colors | | | |
| Plain Colors | | | |
| Aquamarine M HF (202) | ■ | ■ | ■ |
| Emerald M HF (205) | ■ | ■ | ■ |
| Graphite M HF (253) | ■ | ■ | ■ |
| Jet M HF (280) | ■ | ■ | ■ |
| Sapphire M HF (206) | ■ | ■ | ■ |
| Scarlet M HF (276) | ■ | ■ | ■ |
| Vintage Rose M HF (319) | ■ | ■ | ■ |
| Crystal Effects | | | |
| Transparent Effects | | | |
| Crystal Aurore Boreale M HF (001 AB) | ■ | ■ | ■ |
| Crystal Golden Shadow M HF (001 GSHA) | ■ | ■ | ■ |

2709 Rhombus Flat Back

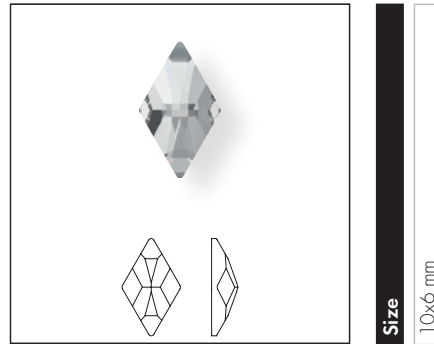

| Crystal | 10x6 mm |
|---------------------------------------|---------|
| Crystal M HF (001) | ■ |
| Crystal Effects | |
| Transparent Effects | |
| Crystal Aurore Boreale M HF (001 AB) | ■ |
| Crystal Golden Shadow M HF (001 GSHA) | ■ |

2711 Triangle Flat Back

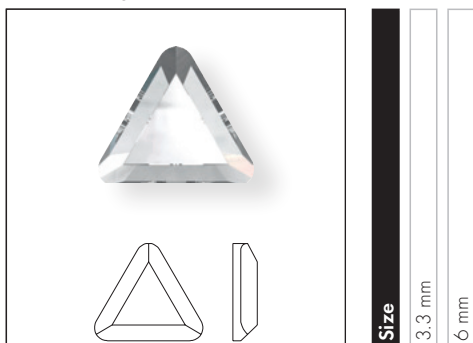

- Crystal**
- Crystal M HF (001)
- Colors**
- Plain Colors**
- Jet M HF (280)
- Crystal Effects**
- Transparent Effects**
- Crystal Aurore Boreale M HF (001 AB)
- Crystal Golden Shadow M HF (001 GSHA)

2715 Connector Flat Back

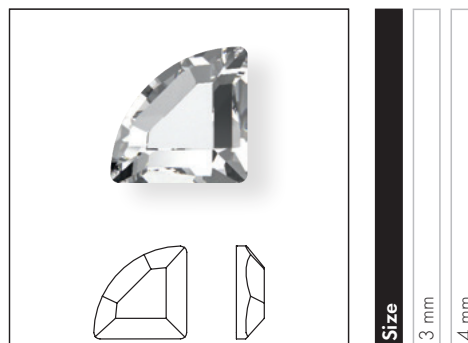

- Crystal**
- Crystal M HF (001)
- Colors**
- Plain Colors**
- Amethyst M HF (204)
- Aquamarine M HF (202)
- Emerald M HF (205)
- Jet M HF (280)
- Light Colorado Topaz M HF (246)
- Scarlet M HF (276)
- Crystal Effects**
- Transparent Effects**
- Crystal Aurore Boreale M HF (001 AB)
- Crystal Golden Shadow M HF (001 GSHA)
- Crystal Silver Night M HF (001 SINI)
- Metallic Effects**
- Crystal Light Chrome M HF (001 LTCH)
- Color Effects**
- Metallic Effects**
- Jet Hematite M HF (280 HEM)

TRIANGLE FAMILY

2738 Triangle Alpha Flat Back

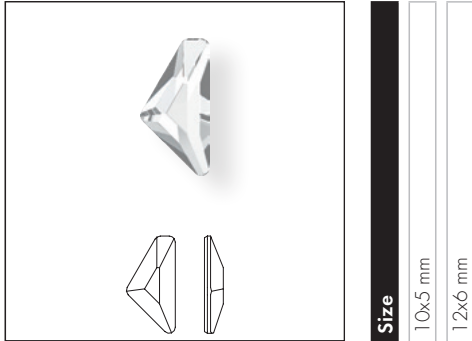

Size

10x5 mm

12x6 mm

Crystal

Crystal M HF (001)

Crystal Effects

Transparent Effects

Crystal Aurore Boreale M HF (001 AB)

Crystal Golden Shadow M HF (001 GSHA)

Crystal Silver Night M HF (001 SINI)

2739 Triangle Beta Flat Back



Size

5.8x5.3 mm

7x6.5 mm

Crystal

Crystal M HF (001)

Crystal Effects

Transparent Effects

Crystal Aurore Boreale M HF (001 AB)

Crystal Golden Shadow M HF (001 GSHA)

Crystal Silver Night M HF (001 SINI)

2740 Triangle Gamma Flat Back

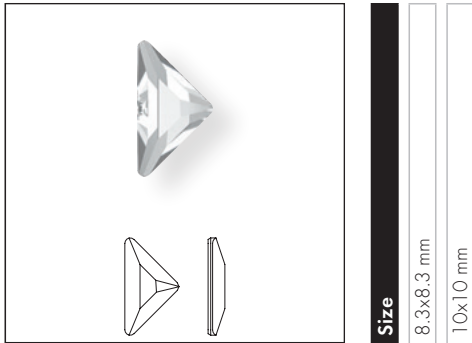

Size

8.3x8.3 mm

10x10 mm

Crystal

Crystal M HF (001)

Crystal Effects

Transparent Effects

Crystal Aurore Boreale M HF (001 AB)

Crystal Golden Shadow M HF (001 GSHA)

Crystal Silver Night M HF (001 SINI)

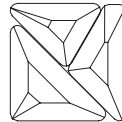

When Alpha, Beta, and Gamma Flat Backs are arranged together, they form a square.

2754 Star Flower Flat Back HF

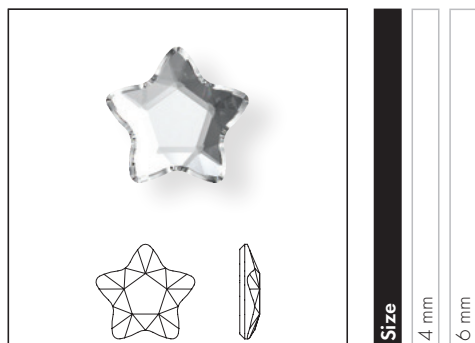

Size
4 mm
6 mm

Crystal

Crystal M HF (001)

Colors

Plain Colors

Amethyst M HF (204)

Aquamarine M HF (202)

Iris M HF (219)

Jet M HF (280)

Light Rose M HF (223)

Light Topaz M HF (226)

Peridot M HF (214)

Rose M HF (209)

Scarlet M HF (276)

Crystal Effects

Transparent Effects

Crystal Aurore Boreale M HF (001 AB)

Crystal Golden Shadow M HF (001 GSHA)

2770 Wing Flat Back

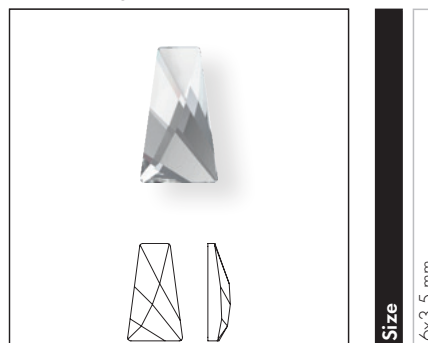

Size
6x3.5 mm

Crystal

Crystal M HF (001)

Crystal Effects

Transparent Effects

Crystal Aurore Boreale M HF (001 AB)

GEOMETRIC FLAT BACKS

2771 Kite Flat Back

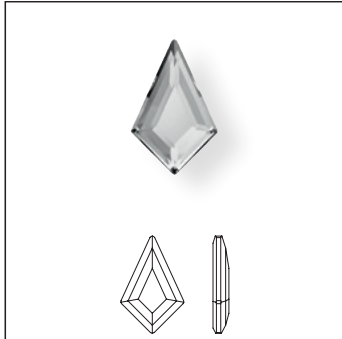

| Size |
|-------------|
| 6.4x4.2 mm |
| 8.6x5.6 mm |
| 12.9x8.3 mm |

| Crystal |
|---------------------------------------|
| Crystal M HF (001) |
| Colors |
| Plain Colors |
| Black Diamond M HF (215) |
| Light Rose M HF (223) |
| Light Siam M HF (227) |
| Crystal Effects |
| Transparent Effects |
| Crystal Aurore Boreale M HF (001 AB) |
| Crystal Golden Shadow M HF (001 GSHA) |
| Color Effects |
| Metallic Effects |
| Jet Hematite M HF (280 HEM) |

2772 Trapeze Flat Back

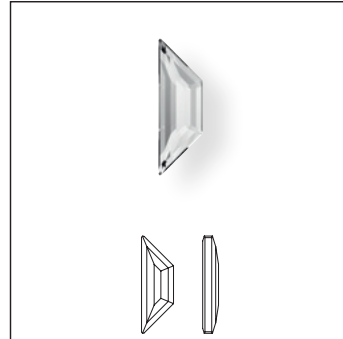

| Size |
|-------------|
| 6.5x2.1 mm |
| 8.6x2.8 mm |
| 12.9x4.2 mm |

| Crystal |
|---------------------------------------|
| Crystal M HF (001) |
| Colors |
| Plain Colors |
| Black Diamond M HF (215) |
| Crystal Effects |
| Transparent Effects |
| Crystal Aurore Boreale M HF (001 AB) |
| Crystal Golden Shadow M HF (001 GSHA) |
| Color Effects |
| Metallic Effects |
| Jet Hematite M HF (280 HEM) |

2773 Diamond Shape Flat Back

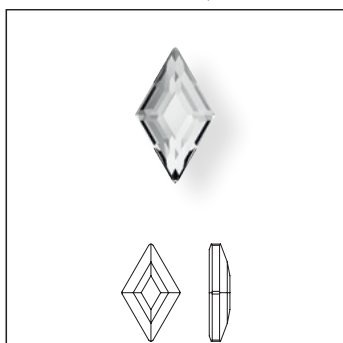

| Size | 5x3 mm | 6.6x3.9 mm | 9.9x5.9 mm |
|------|--------|------------|------------|
|------|--------|------------|------------|

- Crystal**
- Crystal M HF (001)
- Colors**
- Plain Colors**
- Black Diamond M HF (215)
- Light Rose M HF (223)
- Light Siam M HF (227)
- Crystal Effects**
- Transparent Effects**
- Crystal Aurore Boreale M HF (001 AB)
- Crystal Golden Shadow M HF (001 GSHA)
- Color Effects**
- Metallic Effects**
- Jet Hematite M HF (280 HEM)

2774 Elongated Pentagon Flat Back

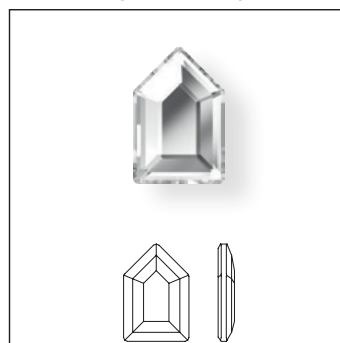

| Size | 6.3x4.2 mm | 8.3x5.6 mm | 12.5x8.4 mm |
|------|------------|------------|-------------|
|------|------------|------------|-------------|

- Crystal**
- Crystal M HF (001)
- Colors**
- Plain Colors**
- Black Diamond M HF (215)
- Light Siam M HF (227)
- Crystal Effects**
- Transparent Effects**
- Crystal Aurore Boreale M HF (001 AB)
- Color Effects**
- Metallic Effects**
- Jet Hematite M HF (280 HEM)

2775 Concise Pentagon Flat Back



| | | | |
|-------------|----------|------------|-----------|
| Size | 5x4.2 mm | 6.7x5.6 mm | 10x8.4 mm |
|-------------|----------|------------|-----------|

| | | | |
|---|--------------------|--|--|
| Crystal | Crystal M HF (001) | | |
| Colors | | | |
| Plain Colors | | | |
| Black Diamond M HF (215) | | | |
| Light Siam M HF (227) | | | |
| Crystal Effects | | | |
| Transparent Effects | | | |
| Crystal Aurore Boreale M HF (001 AB) | | | |
| Color Effects | | | |
| Metallic Effects | | | |
| Jet Hematite M HF (280 HEM) | | | |

2776 Elongated Hexagon Flat Back

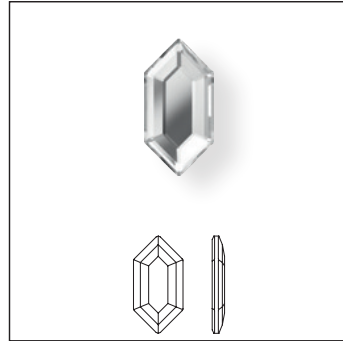

| | | | |
|-------------|------------|-----------|-------------|
| Size | 8.2x4.2 mm | 11x5.6 mm | 16.5x8.4 mm |
|-------------|------------|-----------|-------------|

| | | | |
|---|-----------------------|--|--|
| Crystal | Crystal M HF HF (001) | | |
| Colors | | | |
| Plain Colors | | | |
| Black Diamond M HF (215) | | | |
| Light Siam M HF (227) | | | |
| Crystal Effects | | | |
| Transparent Effects | | | |
| Crystal Aurore Boreale M HF (001 AB) | | | |
| Color Effects | | | |
| Metallic Effects | | | |
| Jet Hematite M HF (280 HEM) | | | |

2777 Concise Hexagon Flat Back

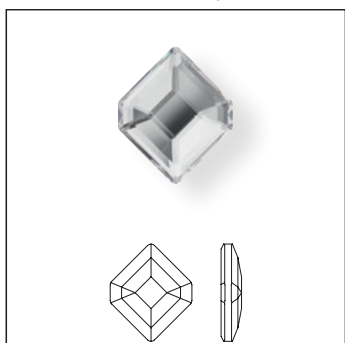

- Crystal**
- Crystal M HF (001)
- Colors**
- Plain Colors**
- Black Diamond M HF (215)
- Light Siam M HF (227)
- Crystal Effects**
- Transparent Effects**
- Crystal Aurore Boreale M HF (001 AB)
- Color Effects**
- Metallic Effects**
- Jet Hematite M HF (280 HEM)

2788 Wave Flat Back

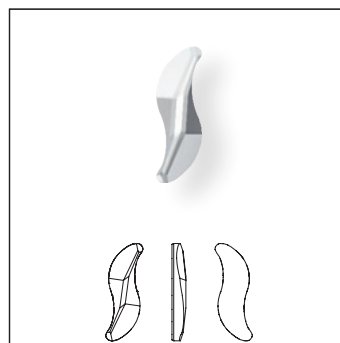

- Crystal**
- Crystal M HF (001)
- Crystal Effects**
- Transparent Effects**
- Crystal Aurore Boreale M HF (001 AB)

03

2808 Heart Flat Back

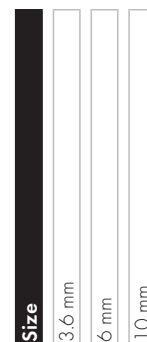
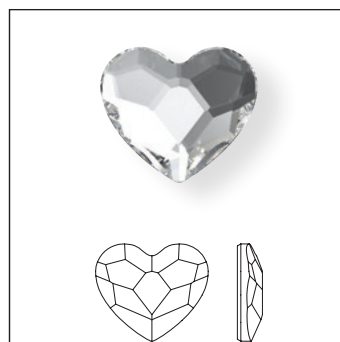

- Crystal**
- Crystal M HF (001)
- Colors**
- Plain Colors**
- Fuchsia M HF (502)
- Jet M HF (280)
- Light Siam M HF (227)
- Crystal Effects**
- Transparent Effects**
- Crystal Aurore Boreale M HF (001 AB)
- Crystal Golden Shadow M HF (001 GSHA)

2813 Moon Flat Back Hotfix

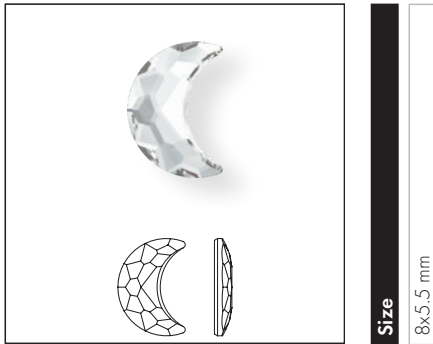

Size

8x5.5 mm

Crystal

Crystal M HF (001)

Crystal Effects

Transparent Effects

Crystal Aurore Boreale M HF (001 AB)

2816 Rivoli Star Flat Back

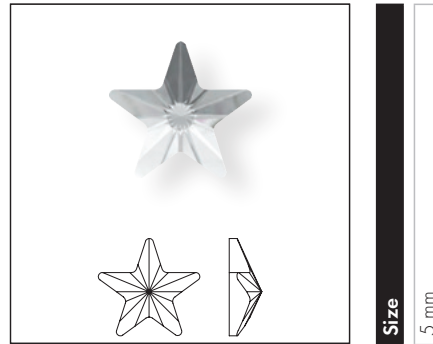

Size

5 mm

Crystal

Crystal M HF (001)

Colors

Plain Colors

Jet M HF (280)

Crystal Effects

Transparent Effects

Crystal Aurore Boreale M HF (001 AB)

Color Effects

Metallic Effects

Jet Hematite M HF (280 HEM)

Product Details

| Article Size | Packing Unit = Minimum Order Quantity in Pieces | Average Net Weight in Gram per Packing Unit Crystal (001) | Average Gross Weight in Gram per Packing Unit Crystal (001) |
|--------------------|---|---|---|
| 1098 A HF | | | |
| PP 24 (SS 12) | 1440 | 20.96 | 31.16 |
| PP 31 (SS 16) | 1440 | 41.13 | 51.33 |
| SS 20 | 720 | 36.58 | 46.78 |
| 2000 A HF | | | |
| SS 3 | 1,440 | 1.8 | 12.7 |
| 2038 A HF | | | |
| SS 5 | 1,440 | 4.2 | 12.1 |
| SS 6 | 1,440 | 5.4 | 17.7 |
| SS 8 | 1,440 | 9.96 | 18.2 |
| SS 10 | 1,440 | 15.54 | 24.3 |
| 2038/1 | | | |
| SS 10 | 1440 | 15.7 | 24.4 |
| 2078 A HF | | | |
| SS 12 | 1,440 | 21.6 | 30.4 |
| SS 16 | 1,440 | 39.1 | 47.1 |
| SS 20 | 1,440 | 72.0 | 79.6 |
| SS 30 | 288 | 34.6 | 63.0 |
| SS 34 | 144 | 26.0 | 48.6 |
| SS 40 | 144 | 43.2 | 66.9 |
| SS 48 | 96 | 61.4 | 87.4 |
| 2078/1 A HF | | | |
| SS 16 | 1,440 | 39.1 | 47.1 |
| SS 20 | 1,440 | 72.0 | 79.6 |
| 2080/4 HF | | | |
| SS 6 | 1,440 | 6.5 | 16.7 |
| SS 10 | 1,440 | 17.1 | 28.3 |
| SS 16 | 1,440 | 43.4 | 54.9 |
| SS 20 | 1,440 | 82.9 | 93.1 |
| SS 34 | 144 | 23.2 | 34.1 |
| 2200 M HF | | | |
| 4x2 mm | 720 | 6.5 | 18.5 |
| 8x4 mm | 360 | 24.8 | 35.8 |
| 2201 M HF | | | |
| 4x1.8 mm | 720 | 5.7 | 15.9 |
| 8x3.5 mm | 144 | 10.03 | 31.11 |
| 14x6 mm | 72 | 21.67 | 45.27 |
| 2205 M HF | | | |
| 7.5 mm | 288 | 20.3 | 30.5 |
| 10 mm | 144 | 17.6 | 42.4 |
| 14 mm | 72 | 22.3 | 45.9 |
| 2300 M HF | | | |
| 8x4.8 mm | 360 | 41.9 | 51.0 |
| 2303 M HF | | | |
| 8x5 mm | 144 | 15.70 | 39.60 |
| 14x9 mm | 72 | 36.65 | 60.25 |

| Article Size | Packing Unit = Minimum Order Quantity in Pieces | Average Net Weight in Gram per Packing Unit Crystal (001) | Average Gross Weight in Gram per Packing Unit Crystal (001) |
|------------------|---|---|---|
| 2304 M HF | | | |
| 10x2.8 mm | 180 | 10.2 | 20.4 |
| 14x3.9 mm | 96 | 13.1 | 36.3 |
| 2400 M HF | | | |
| 2.2 mm | 1,440 | 9.65 | 18.5 |
| 3 mm | 1,440 | 25.3 | 36.8 |
| 4 mm | 720 | 30.0 | 41.0 |
| 6 mm | 144 | 21.9 | 32.7 |
| 2471 M HF | | | |
| 5 mm | 288 | 17.3 | 25.6 |
| 7 mm | 72 | 11.9 | 35.1 |
| 10 mm | 72 | 30.2 | 51.6 |
| 2472 M HF | | | |
| 5 mm | 288 | 17.4 | 27.6 |
| 7 mm | 144 | 20.8 | 42.8 |
| 10 mm | 96 | 34.5 | 56.5 |
| 2510 M HF | | | |
| 3.7x1.9 mm | 720 | 8.2 | 10.6 |
| 5x2.5 mm | 720 | 23.2 | 32.3 |
| 2555 M HF | | | |
| 8x2.6 mm | 240 | 18.4 | 27.5 |
| 12x4 mm | 144 | 28.8 | 33.6 |
| 2602 M HF | | | |
| 3.7x2.5 mm | 720 | 11.5 | 21.7 |
| 8x5.5 mm | 144 | 17.89 | 41.79 |
| 14x10 mm | 72 | 58.61 | 82.21 |
| 2603 M HF | | | |
| 4x3 mm | 288 | 6.8 | 17.0 |
| 8x6 mm | 144 | 21.7 | 43.7 |
| 14x10 mm | 72 | 50.3 | 72.3 |
| 2709 M HF | | | |
| 10x6 mm | 288 | 28.9 | 67.2 |
| 2711 M HF | | | |
| 3.3 mm | 720 | 6.38 | 15.63 |
| 6 mm | 360 | 29.7 | 40.7 |
| 2715 M HF | | | |
| 3 mm | 288 | 4.0 | 14.2 |
| 4 mm | 288 | 8.2 | 18.4 |
| 2716 M HF | | | |
| 5 mm | 720 | 35.8 | 75.1 |
| 2738 M HF | | | |
| 10x5 mm | 144 | 16.7 | 35.1 |
| 12x6 mm | 96 | 20.2 | 38.3 |
| 2739 M HF | | | |
| 5.8x5.3 mm | 216 | 19.2 | 41.9 |
| 7x6.5 mm | 144 | 22.6 | 39.8 |

| Article Size | Packing Unit = Minimum Order Quantity in Pieces | Average Net Weight in Gram per Packing Unit Crystal (001) | Average Gross Weight in Gram per Packing Unit Crystal (001) |
|------------------|---|---|---|
| 2740 M HF | | | |
| 8.3x8.3 mm | 216 | 35.1 | 54.2 |
| 10x10 mm | 96 | 25.1 | 41.1 |
| 2754 M HF | | | |
| 4 mm | 720 | 13.6 | 23.8 |
| 6 mm | 360 | 20.5 | 30.7 |
| 2770 M HF | | | |
| 6x3.5 mm | 1,440 | 60.3 | 70.3 |
| 2771 M HF | | | |
| 6.4x4.2 mm | 288 | 9.04 | 17.87 |
| 8.6x5.6 mm | 216 | 16.84 | 43.02 |
| 12.9x8.3 mm | 144 | 36.29 | 61.39 |
| 2772 M HF | | | |
| 6.5x2.1 mm | 288 | 6.39 | 15.17 |
| 8.6x2.8 mm | 288 | 16.29 | 40.71 |
| 12.9x4.2 mm | 144 | 25.57 | 53.86 |
| 2773 M HF | | | |
| 5x3 mm | 288 | 4.83 | 13.66 |
| 6.6x3.9 mm | 288 | 11.23 | 35.65 |
| 9.9x5.9 mm | 144 | 19.30 | 43.39 |
| 2774 M HF | | | |
| 6.3x4.2 mm | 288 | 18.7 | 29.6 |
| 8.3x5.6 mm | 144 | 19.5 | 39.4 |
| 12.5x8.4 mm | 96 | 39.0 | 60.3 |
| 2775 M HF | | | |
| 5x4.2 mm | 288 | 13.9 | 24.7 |
| 6.7x5.6 mm | 144 | 15.0 | 34.3 |
| 10x8.4 mm | 144 | 43.6 | 66.4 |
| 2776 M HF | | | |
| 8.2x4.2 mm | 144 | 11.2 | 30.1 |
| 11x5.6 mm | 72 | 11.3 | 28.8 |
| 16.5x8.4 mm | 72 | 35.6 | 55.8 |
| 2777 M HF | | | |
| 5x4.2 mm | 288 | 10.4 | 21.3 |
| 6.7x5.6 mm | 144 | 10.5 | 29.7 |
| 10x8.4 mm | 144 | 32.8 | 52.7 |
| 2788 M HF | | | |
| 8 mm | 288 | 7.5 | 18.4 |
| 2808 M HF | | | |
| 3.6 mm | 720 | 18.4 | 20.8 |
| 6 mm | 288 | 19.8 | 28.9 |
| 10 mm | 144 | 38.8 | 55.9 |
| 2813 M HF | | | |
| 8x5.5 mm | 144 | 13.1 | 37.7 |
| 2816 M HF | | | |
| 5 mm | 720 | 23.6 | 30.7 |